

# Thinking Skills Assessment Oxford

4502/01

Wednesday 5<sup>th</sup> November

Morning

90 minutes

## SECTION 1 Thinking Skills Assessment

\* 1 1 0 9 9 7 1 6 5 8 \*

### Instructions to Candidates

Please read this page carefully, but do not open this question paper until you are told that you may do so.

A separate answer sheet is provided for this section. Please check you have one. You also require a soft pencil and an eraser.

Please write your name, date of birth, TSA Oxford candidate number and centre number in the spaces provided on the answer sheet. Please write very clearly.

Speed as well as accuracy is important in this section. **Work quickly, or you may not finish the paper.** There are no penalties for incorrect responses, only points for correct answers, so you should attempt all fifty questions. All questions are worth one mark.

Answer on the sheet provided. Questions ask you to show your choice between five options. Choose the **one** option you consider correct and record your choice on the separate answer sheet. If you make a mistake, erase thoroughly and try again.

Any rough work should be done on this question paper.

Calculators are NOT permitted.



Developed and administered on behalf of the University of Oxford by Cambridge Assessment.

© Copyright UCLES 2008

Please wait to be told you may begin before turning this page.

*This paper consists of 31 printed pages and 1 blank page.*

- 1 Sometimes poverty is defined in relation to average income. For example, people may be said to be poor if their income is less than 60 per cent of the average income for the population. This is not a legitimate definition, because it is a measure of inequality rather than poverty. This is obvious if we consider the consequences of using the definition. It means that a huge pay rise for middle managers automatically throws some people into poverty, even though their income has not changed. On the other hand, the definition implies that in a society where almost everyone is starving, no one is poor.

Which of the following best expresses the main conclusion of the above argument?

- A Having a relatively low income is not the same as being poor.
  - B It is impossible to find an appropriate definition of poverty.
  - C It is wrong to define poverty in relation to average income.
  - D A huge pay rise for middle managers makes other people poor.
  - E There is no inequality in a society where most people are starving.
- 2 A child's bus fare is cheaper than the adult fare but is more than half the adult fare. The total cost of a single journey for an adult and two children is £1.20. Adult fares are all multiples of 10 p.

What is the adult fare?

- A 30 p
- B 40 p
- C 50 p
- D 60 p
- E 70 p

- 3 Over the past ten years, there has been a four-fold increase in the number of people killed in road accidents who are found to have illegal drugs in their bodies. The rate of increase is much greater than the corresponding rate for those people killed in accidents who were found with alcohol in their blood. This shows that the campaign against drink-driving has succeeded. Consequently, the Government ought now to concentrate on targeting those people who drive whilst under the influence of illegal drugs.

Which of the following is the best statement of the flaw in the argument above?

- A Those people who take illegal drugs and drive are likely to be different from those who drink and drive.
  - B Targeting people who drive under the influence of illegal drugs ignores those people who take drugs but do not drive.
  - C The success of the drink-driving campaign does not mean that a campaign against drivers who take drugs would succeed.
  - D The increase in drug-related road deaths is insufficient to conclude that the drink-driving campaign has succeeded.
  - E Evidence on the number of drug-related road accidents needs to distinguish between illegal drugs and legal drugs.
- 4 Socialist politicians are often taunted by their opponents for leading lifestyles similar to those of their capitalist counterparts. The theme of the taunts runs like this; 'You object on socialist principles to gross inequalities in the distribution of wealth; yet you enjoy a higher personal standard of living than the majority of the population. Therefore you are not really a socialist'. But the jibe can easily be answered, for there is no hypocrisy in arguing, even from a privileged position, for a fairer and more equal society.

Which of the following is a conclusion which can be reliably drawn from the passage as a whole?

- A Socialists who enjoy personal wealth cannot object to others who amass even greater wealth.
- B Someone can be a genuine socialist whilst enjoying a high standard of living.
- C Calls for reform are more effective if they come from the more privileged classes of society.
- D There is nothing immoral about inequalities in the distribution of wealth.
- E It is hypocritical to claim to be a socialist if one enjoys a standard of living above the average.

- 5 The Executive of the Students' Union has recently carried out a survey to identify dangerous areas on campus. The survey led to the recommendation and implementation of measures such as improved lighting in suspect areas. Such reforms can only help to reduce the number of attacks on campus.

However, the University lake and its surrounding area was not included in the survey as, despite being considered part of the campus, it actually belongs to the City Council. This means the University has no direct influence over safety standards in the area. It should therefore definitely be avoided by lone students at night.

Which one of the following is an underlying assumption of this argument?

- A Students do not look after their own safety but rely on others to take safety measures on their behalf.
  - B The City Council regard the lake area as part of the campus.
  - C Students walking on and off campus at night would go via the university lake.
  - D The safety measures taken by the City Council are either non-existent or are inferior to those implemented by the Student Union.
  - E The Executive of the Student Union is not merely seeking popularity in implementing its reforms but is genuinely concerned about safety risks.
- 6 Steven has a customised motorcycle that he is very proud of and shows regularly in competitions. It is very important to him that his presentation is perfect and he likes to stop in front of the judges with both his tyre valves in the same position. The front tyre is smaller than the rear to aid its handling. The circumference of the front wheel is 2m and the circumference of the rear wheel is 2.5m.

Steven starts with both valves in the same position at the bottom of each wheel.

How far must he drive before the valves line up again at the bottom of each wheel?

- A 2.0 m
- B 2.5 m
- C 4.5 m
- D 10.0 m
- E 12.5 m

- 7 I have so many four digit code numbers to remember that I cannot keep them all in my head. The banks say you should not write down your Personal Identification Numbers (PINs) for cash and credit cards and keep them in a wallet with the cards. So I can find out what the numbers are, I have devised a code which should be complicated enough to confuse any thief who steals my wallet. I code all the numbers using 1=A, 2=B up to 9=I, 0=J. Then I write the coded numbers down backwards so 1234 is written DCBA. Finally at the end of each coded number I add an extra letter between A and J to say what that particular code is of: C is for credit card; F is for phone card; B is for bicycle lock combination; E is for my Eastern Bank card and D is for my Denton Building Society card.

My list looks as follows:

A D G E F  
C J D B E  
B G F A C  
G J A C D  
D F G C B

What is my bicycle lock combination?

- A** 4673  
**B** 5741  
**C** 7613  
**D** 4356  
**E** 3764

- 8 The drawing shows a sculpture as seen from above.

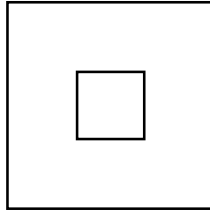

Which of these could **not** be a view from one of the sides?

A

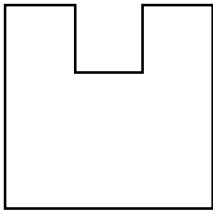

B

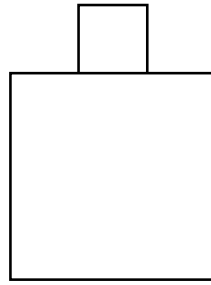

C

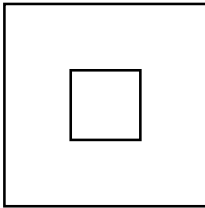

D

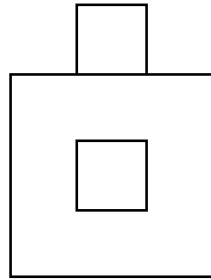

E



- 9** Some of the great sea-mammals, such as the sperm whale, have brains many times larger than ours. It is a fact of evolution that organs do not grow or remain large unless they are used; if they are not used they shrink or even disappear. It must be concluded therefore that the sperm whale makes intelligent use of the vast brain it possesses, perhaps at thought levels well beyond our understanding.

Which of the following would, if true, weaken the argument?

- A** Humans have developed intelligence despite having smaller brains than whales.
  - B** Whales lack the ability to communicate in language.
  - C** Large brains may have uses that do not involve intelligence.
  - D** There is no correlation between the size of the animal and the size of its brain.
  - E** Whale intelligence may be of a kind that humans do not recognise.
- 10** Mrs Jackson said that, if Mrs List were promoted, she would resign and we definitely do not want to lose Mrs Jackson. However, we are not going to promote Mrs List: we are going to offer the promotion to Mr Wade. Therefore Mrs Jackson will not resign.

Which of the following is the best statement of the flaw in the argument?

- A** It implies that Mrs Jackson threatened to resign because she wanted the promotion herself.
- B** It does not explain why it is so important to keep Mrs Jackson.
- C** It overlooks the possibility that Mrs Jackson might resign even if Mrs List is not promoted.
- D** It overlooks the possibility that Mrs Jackson would not have resigned even if Mrs List had been promoted.
- E** It overlooks the possibility that Mr Wade might not accept the promotion.

- 11** There is much evidence to suggest that cannabis has therapeutic uses for people suffering from conditions such as multiple sclerosis. Given this, the prescription of cannabis should be made legal. If doctors were legally allowed to prescribe cannabis, multiple sclerosis sufferers and others might be spared much pain. Moreover, if cannabis could be legally prescribed, it would be possible to conduct large-scale surveys to establish whether cannabis really is of benefit in such cases.

Which of the following best expresses the main conclusion of the above argument?

- A** There is no justification for existing laws against cannabis.
  - B** Cannabis can relieve the suffering of people with multiple sclerosis.
  - C** Doctors are opposed to existing laws on cannabis.
  - D** It should be legal for doctors to prescribe cannabis.
  - E** Large-scale surveys are needed to establish whether cannabis really is beneficial.
- 12** Pierre and Marc are waiters. In one particular month, Pierre worked 30 sessions at the normal rate and 10 sessions at the overtime rate. Marc worked 20 sessions at the normal rate and 5 sessions at the overtime rate. At the end of this month, Pierre earned 700 euros. Marc earned 425 euros.

What is the overtime rate per session?

- A** 35 euros
- B** 30 euros
- C** 25 euros
- D** 20 euros
- E** 15 euros



- 13 The chart below shows the distribution of results this season for the Arlsear Strikers hockey team. They have played 24 matches to date and lost none.

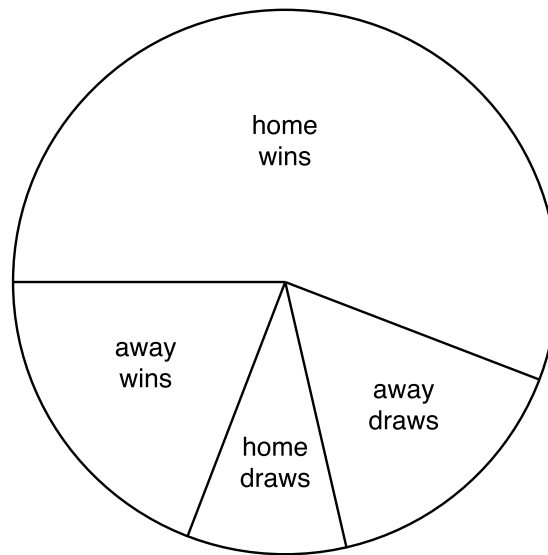

How many matches have they won?

- A 4
- B 6
- C 14
- D 16
- E 18

14 The cut out below was folded together to make a cube.

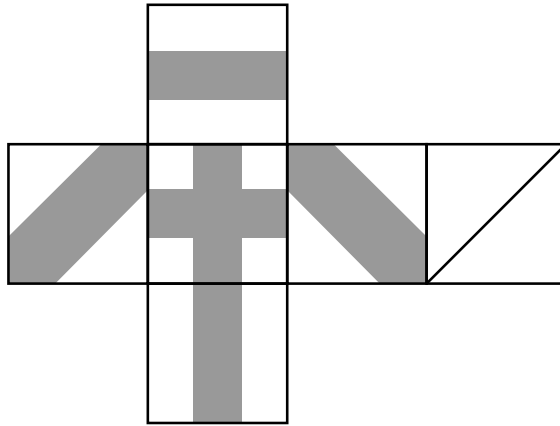

Which of the following cubes was formed from this cut-out?

A

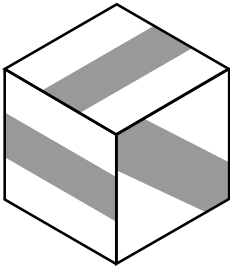

B

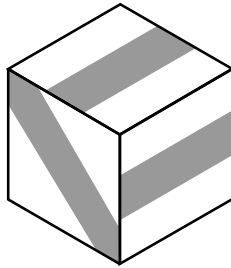

C

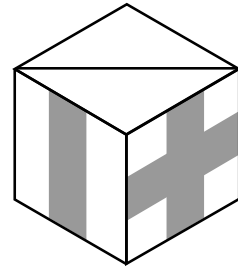

D

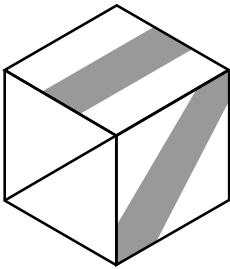

E

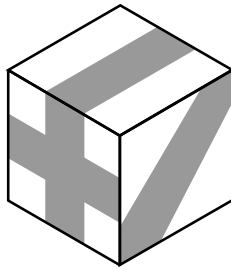

- 15** Random drug-testing of prisoners was introduced in 1995 in order to solve the many problems associated with prisoners taking drugs. Since cannabis can be detected in the body up to a month after having been smoked, prisoners are tempted to switch to heroin, which stays in the system for only 48 hours. As a result, since drug-testing was introduced, cannabis use has declined by a fifth whereas heroin use has doubled. Heroin is not only a much more damaging drug than cannabis, but it is also extremely addictive. There is evidence that heroin addiction encourages prisoners to intimidate others in order to pay for the drug.

Which one of the following is a conclusion which can be drawn from the above passage?

- A** The test for detection of heroin in the body should be improved.
  - B** Since 1995, cannabis use in prisons is at a lower level than heroin use.
  - C** The drug-problem in prisons cannot be solved by random drug-testing.
  - D** The system of drug-testing of prisoners has not solved the drug-problem in prisons.
  - E** The level of intimidation in prisons has doubled since the introduction of random drug-testing.
- 16** It is not always clear whether a doctor should tell the truth to a patient or not. On the one hand, patients have a right to know what is the matter with them and what the future holds, so that they can make their own informed decisions, however upsetting the truth may be. It is a simple issue of human rights. But on the other hand, a patient's health may sometimes be better served by not knowing a frightening truth. For instance, a doctor may believe that a patient's medical condition will actually worsen if they realise how serious it is. Therefore, there are cases in which doctors have no choice: they must decide in favour of deceiving the patient.

Which of the following is an underlying assumption of the above argument?

- A** Patients accept that a doctor has a responsibility to decide what will be in their best interests.
- B** Doctors have a duty to conceal the truth if they believe it will frighten the patient.
- C** Doctors have a duty to tell their patients the truth even when the truth would upset them.
- D** Doctors have a greater responsibility for a patient's well-being than for their right to know the truth.
- E** It is the responsibility of doctors to respect a patient's human rights whatever their medical condition.

- 17** Birds of the tit family are very fond of tearing paper - wallpaper, newspaper, notices and bank notes included. They make no use of the paper they have torn. We might explain this puzzling behaviour by noting that the technique that they use for tearing paper is identical to their technique for stripping tree bark to search for insects to eat. This indicates that tits that tear paper are searching for food.

Which of the following, if true, would most weaken the above argument?

- A** On many occasions tits reject food on bird tables to tear paper.
  - B** Tits carry on tearing paper even when it is obvious to humans that no food is forthcoming.
  - C** Eighty per cent of householders who reported paper tearing behaviour fed the birds.
  - D** Tits use moss from trees and wool from dead sheep for nesting materials.
  - E** Animals often engage in apparently pointless activities that turn out to have a purpose.
- 18** Inflation in Bolandia has been a steady 10% per year for many years. Evitan, a Bolandian citizen, bought his car one year ago for 500 Bols. He now wants to trade in his car for an identical model. He can expect to receive 80% of the current new value of his existing car. The price of new models has increased in line with inflation.

How many extra Bols will he have to pay for his new car?

- A** 50
- B** 55
- C** 60
- D** 100
- E** 110

- 19 The table below shows the unemployment rate and percent change in industrial production over the last year for several countries.

	<b>INDUSTRIAL PRODUCTION</b> Annual Change %		<b>UNEMPLOYMENT</b> Rate %	
	Latest	Year ago	Latest	Year ago
Belgium	-2.6	-2.5	8.9	10.6
Canada	6.9	5.4	9.6	11.2
France	4.7	-4.3	12.7	12.1
Germany	5.5	-4.0	9.1	9.0
Italy	7.3	-1.3	12.5	10.7
Japan	5.9	-3.2	2.9	2.8
Netherlands	1.2	2.4	9.6	8.4
Spain	4.9	-6.8	24.1	22.1
Sweden	8.2	-1.8	8.1	8.7
UK	4.2	3.3	8.8	10.0
USA	5.7	3.4	5.4	6.4

Which country has had a larger percentage increase in industrial production and greater fall in the percentage unemployed than the UK over the last year?

- A Belgium  
 B Canada  
 C France  
 D Italy  
 E USA
- 20 The roads on Bolandia all run either north - south or east - west and are laid out on a 5km grid. Ahmed and Wayne are delivery drivers. One morning, Ahmed starts at Abbeytown and drives 5km west then 15km south to reach Barneyville. He then drives 5km east to Carloston. Wayne started at Barneyville, drove 5km south to Denburgh then 10km east and 15km north to Easterby. Ahmed then rings Wayne to arrange to meet for lunch.

If one of them stays where he is, what is the minimum distance the other must drive to meet him?

- A 10 km  
 B 15 km  
 C 25 km  
 D 30 km  
 E 35 km

- 21** The government has announced that it wants to reduce the level of ill-health due to workplace stress. Ministers could learn a lot from a recent study of 8000 white-collar workers in America which found that men who had a high level of control over the way they carried out their jobs had a low rate of heart disease, a stress-related disease. Clearly, therefore, the most stressful jobs are those in which employees have little control over the pace of their work and how it is organised. If the government is serious about wanting to reduce the level of stress-related disease, then it needs to encourage employers to give their workers greater control over their work.

Which of the following is the best statement of a major flaw in the argument?

- A** It contradicts itself by implying that the government is not serious about wanting to reduce stress-related disease.
  - B** It assumes that in general workers want to be given more control over the organisation of their work.
  - C** It ignores the practical question of how much control workers can be given.
  - D** It assumes that where there was a low incidence of heart disease this was caused by a reduction in stress.
  - E** It assumes that stress in the workplace only affects white-collar workers.
- 22** You can become a good pianist if you start to learn at an early age. You did not start to learn until you were an adult, so you cannot become a good pianist.

Which of the following has the same structure as the above argument?

- A** Children can become fluent in two languages if they start learning when very young. My children learnt two languages when young, so they speak them fluently.
- B** You can cure your headache if you are willing to try acupuncture. You refuse to try acupuncture, so you will not be able to cure your headache.
- C** You can avoid being overweight if you take sufficient exercise. You take sufficient exercise, so you will not become overweight.
- D** Children have fewer ear infections if they take cod liver oil. My children have very few ear infections, so they do not need to take cod liver oil.
- E** You can become a good singer if you have perfect pitch. You are a good singer, so you must have perfect pitch.

- 23** If something I do results in someone's death, I am, of course, responsible for that death. But am I similarly responsible if someone's death results from my failure to act? For example, if I go and shoot someone, their death is my fault. But if I refuse to give money to a starving person and that person dies as a result of not having money to buy food, is their death my fault? If I had never lived, the starving person would have died anyway, whereas the person whom I shoot would not have died had it not been for me. So, doing something makes me more responsible for the consequences than when I fail to act.

Which of the following illustrates the principle that the author argues for in the above passage?

- A** The government's refusal to fund the crime prevention programme means that they alone are responsible for the high crime rate.
  - B** Many people who are sent to prison commit further crimes when they come out, which shows that prison fails to make criminals feel responsible for their actions.
  - C** The people more responsible for the high crime rate are the people who break the law, not the local authority for failing to support the crime prevention programme.
  - D** The crime prevention programme does not work because it places the responsibility for crime on the local authority which has insufficient funds to implement it.
  - E** Community service orders work better than prison because they focus the convicted person's mind on the direct consequences of anti-social behaviour.
- 24** A long-running play in London's West End is performed every evening except Sunday. In addition, there are matinee performances every Wednesday, Thursday and Saturday.

What is the maximum number of performances that can be given during a calendar month of 31 days?

- A** 36
- B** 38
- C** 39
- D** 41
- E** 42

- 25 Peter is having a large conservatory built at the back of his house. Below is a plan of the project, showing when each part of the conservatory is to be built.

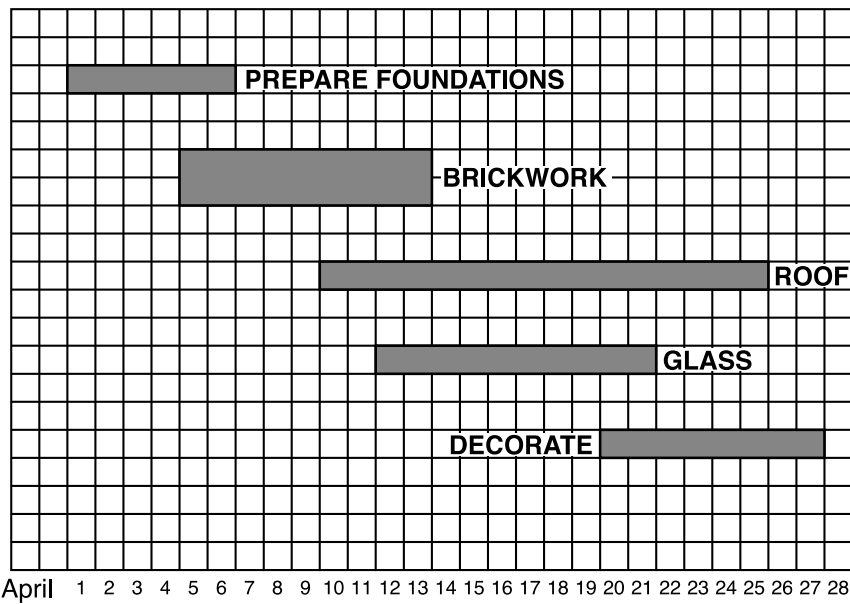

Each blocked square on the plan represents one man for one day.

How many days labour will Peter have to pay for, and what is the maximum number of workers on site at the same time?

- A 48 and 3
- B 48 and 4
- C 58 and 3
- D 58 and 4
- E 58 and 6



26 The design of a tile for a bathroom wall is shown below:



Which of the following patterns may **NOT** be made using only a number of identical tiles as shown?

A

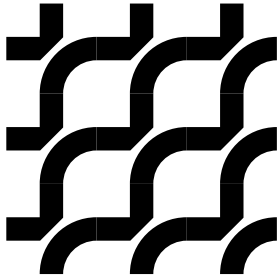

B

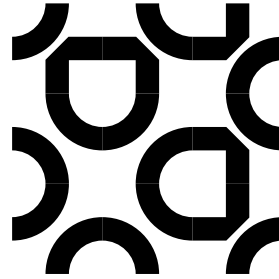

C

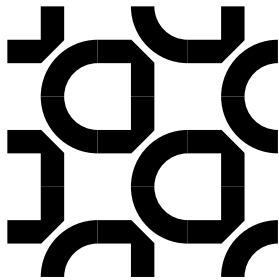

D

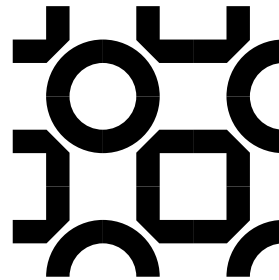

E

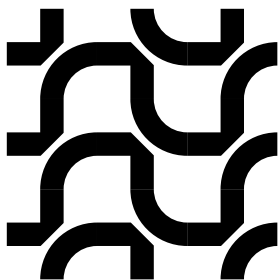

- 27** The quantity of food produced has always fluctuated according to environmental conditions: gluts and shortages have been with us for five hundred years or more. In the past, the free operation of market forces limited the adverse effects of these fluctuations, usually with far more success than any attempts at planned responses. But now we are changing the environment irreversibly. These changes will not only be permanent, but will have such devastating effects on world agriculture that market forces alone will be unable to prevent a global famine. So it is now vital to seek some sort of planned response.

Which one of the following summarises the main conclusion of the argument above?

- A** Environmental changes will have devastating effects on world agriculture.
  - B** Market forces cannot prevent global famine.
  - C** A planned response to current environmental changes is necessary.
  - D** The recent environmental changes cannot be reversed.
  - E** Market forces have limited the adverse effects of the environment on food production.
- 28** Scientists are now developing genetically modified crop plants that produce their own pesticide. But pesticides are only effective if they are not overused; if they are applied continuously for long periods, then the pests that they are supposed to kill develop resistance to them. Pesticides only remain effective against pests, therefore, if periods are left during which they are not used. The genetically modified crop plants will produce pesticides continuously.

Which of the following is a conclusion that can reliably be drawn from the above passage?

- A** The pesticides produced by the genetically modified crop plants become ineffective against pests.
- B** The genetic modification of crop plants will make the crops unusable, as they will be contaminated with pesticide.
- C** The genetically modified crop plants will help to prevent the overuse of pesticides.
- D** The development of genetically modified crop plants will enable more effective use of pesticides, since periods may be left when they are not used.
- E** The development of genetically modified crop plants will mean that pesticides need no longer be sprayed onto fields.

- 29** In the case of plastic drink bottles, recycling is not the best answer to the problem of garbage disposal. Ninety five per cent of soft-drink bottles sold in the United States are made of a compound of polyethylene (PET) which poses recycling problems. They are potentially carcinogenic if recycled into new food or drink containers. Recycled PET tends to absorb other chemicals before re-melting and these chemicals could leach into food or drink that is stored in a recycled container. However, if disposed of in landfill sites, plastic is not harmful to the environment. It can be squashed flat, so that it occupies little space and it is inert. Unlike other waste, it does not leach into soil or water, nor does it produce a dangerous build-up of methane.

Which of the following is an underlying assumption of the argument above?

- A** The space in presently available landfill sites will soon be exhausted.
- B** Soft-drink bottles should be made from materials which can be recycled.
- C** The burning of plastic rubbish is inadvisable because it produces toxic chemicals.
- D** Apart from food and drink containers, there is little use for recycled PET.
- E** A reduction in the amount of plastic produced would ease the problems of garbage disposal.

- 30 I am resurfacing my driveway using bricks in the pattern shown below. The visible part of the brick measures 10cm by 20cm. To achieve a rectangular shape, part of some of the bricks must be cut off. The part which is cut off can be used elsewhere on the drive. The diagram shows that eight bricks would be required to cover an area 40cm by 40cm:

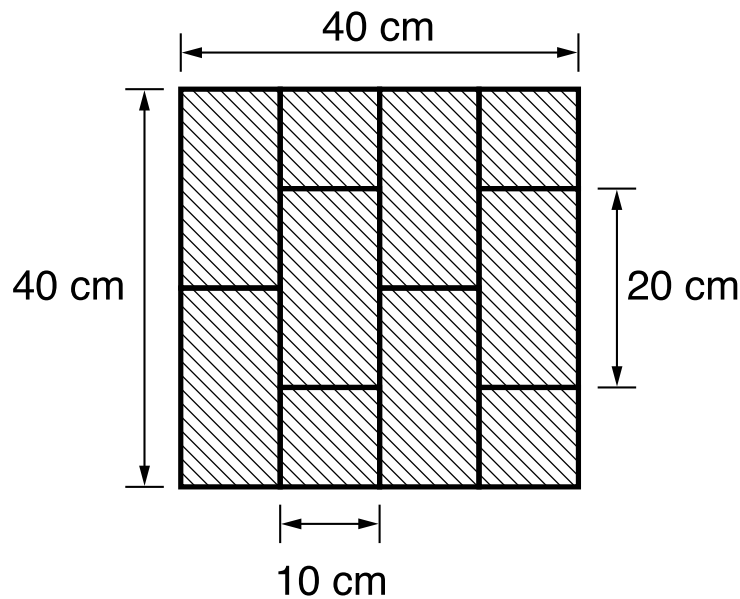

What is the minimum number of bricks needed to resurface a rectangular drive measuring 550cm by 400cm?

- A 1080 bricks
  - B 1100 bricks
  - C 1120 bricks
  - D 1127 bricks
  - E 1128 bricks
- 31 John has 15kg of general potting compost which is made up of  $\frac{1}{3}$  sand and  $\frac{2}{3}$  coir. He wants compost to repot some conifers which require a better draining mixture of 60% sand to 40% coir.

How much sand does he have to add to his general purpose compost to make it suitable for conifers?

- A 5 kg
- B 10 kg
- C 15 kg
- D 20 kg
- E 25 kg

- 32** A netball tournament is divided into two stages. In the first stage, the teams are divided into equal groups within which each team plays every other team once. In the second stage, the winners of each group take part in a knockout competition which starts with four quarter finals.

Which of the following could be the number of teams starting the tournament?

- A** 8
- B** 20
- C** 44
- D** 50
- E** 72

- 33** Catalytic convertors are increasingly being fitted to cars as a means of reducing some of the harmful emissions from car exhausts. But, though they eliminate one form of pollution, their action serves only to create another one. Ground-level ozone is kept at very low levels in the cities by some of the pollutants catalysts remove. So the more catalytic convertors that are fitted, the more such ozone can build up. Since ozone is a major cause of choking summer smogs, we can assume that people with breathing difficulties, such as asthmatics, will be much worse off the more that catalytic convertors are used. We should stop fitting cars with catalytic convertors.

Which of the following, if true, would most weaken the above argument?

- A** Most cars are not fitted with a catalytic convertor.
- B** Catalytic convertors are the best-known method of reducing harmful car emissions.
- C** The pollutants that catalytic convertors remove can create breathing difficulties.
- D** The number of cases of people with breathing difficulties has risen over the past few years.
- E** Air pollution affecting people with breathing difficulties is also caused by emissions from industry.

- 34** Membership of the European Union (EU) has resulted in the maintenance of economic growth and political stability for the countries that make it up. It is desirable that the countries that used to be part of the Communist Eastern Bloc become comparably prosperous and stable. Therefore the European Union should be enlarged as soon as possible to include more Eastern Bloc countries.

This argument is flawed. Which of the following identifies an error in its reasoning?

- A** It assumes that the Eastern Bloc countries have the potential for growth and stability that the existing members had prior to entry.
  - B** It fails to acknowledge that there are countries outside the EU that are just as prosperous and stable.
  - C** It relies on there being no opposition to the enlargement of the EU from existing member countries.
  - D** It implies that exclusion of the Eastern Bloc countries from the EU would result in their being unstable.
  - E** It assumes that the success of a political affiliation like the EU can be measured in purely economic terms.
- 35** All's fair in love and war - and motor racing. That's how some commentators view the failed attempt by a great driver to disable his main rival's car by steering into it. Had he succeeded, he would have won the championship, because he was ahead on points. Fair? Why not? It may have been dangerous and irresponsible but it was not unfair. This driver had earned his one-point lead in the championship and was trying, like any serious competitor, to defend it. In a reversed situation, the other driver could - and arguably would - have done the same. Motor racing is a tough and uncompromising sport with huge incentives to win at all costs and all the drivers know what to expect.

Which of the following best summarises the main conclusion of the argument above?

- A** It was not unfair of the leading driver to steer into his rival's car.
- B** Motor racing is a fierce and ruthless sport with big rewards for winning.
- C** It is not irresponsible to try to win at all costs.
- D** Some commentators thought that the race had been fought fairly.
- E** Another driver in the same position would have acted in the same way.

- 36** Below is part of an itinerary for flying from London to Kampala. It involves changing flights at Dubai with a wait of 5 hours 15 minutes. All times are local times. Dubai is 4 hours ahead of London and Kampala is 1 hour behind Dubai.

DEPART LONDON (HEATHROW)	22:30 FRI 30.01.04
DEPART DUBAI	14:30 SAT 31.01.04
ARRIVE KAMPALA (ENTEBE)	20:45 SAT 31.01.04

What is the total time spent in the air?

- A** 12 hrs 30 mins
  - B** 14 hrs 00 mins
  - C** 15 hrs 00 mins
  - D** 17 hrs 00 mins
  - E** 19 hrs 15 mins
- 37** Peter needs to separate his sheep into 16 square pens. Each side of a pen is formed by a free-standing barrier known as a hurdle. Each pen must be individually accessible on at least one side so that sheep can be penned or released without a risk of the others escaping.

What is the smallest number of hurdles that Peter must take out to the fields in order to accomplish his task?

- A** 40
  - B** 42
  - C** 48
  - D** 49
  - E** 64
- 38** A piece of ribbon 8m long is folded in half so the two ends are on top of each other. This doubled 4m length is then folded in half again. The folded, 2m length of ribbon is then cut right through at its midway point.

How many cut pieces are there and what are their lengths?

- A** 8 pieces of ribbon each 1m long.
- B** 6 pieces of ribbon, 2 of 2m long and 4 of 1m long.
- C** 5 pieces of ribbon, 3 of 2m long and 2 of 1m long.
- D** 4 pieces of ribbon each 2m long.
- E** 3 pieces of ribbon one 4m long and 2 of 2m long.

- 39** Ecotourism now accounts for twenty per cent of tourists. It should provide a sustainable alternative to overuse of natural resources. However, tourists may introduce new diseases to animal populations. Mongooses and meerkats in Botswana have died from tuberculosis caught from humans, and gorillas in East Africa picked up new internal parasites after the introduction of tourism. Moreover, the presence of humans in increased numbers has been shown to stress polar bears, penguins, dolphins and rainforest birds, affecting their natural routines and reducing breeding success.

Which of the following can reliably be inferred from the above passage?

- A** Subtle changes to wildlife health may not be apparent to a casual observer.
  - B** Many ecotourist projects are ecologically viable.
  - C** Dolphins become increasingly frenetic when tourist boats are present.
  - D** Guidelines for ecotourism mostly address obvious issues such as changes in land use or cutting down trees.
  - E** The benefits of sustainable resources may be outweighed by harm to wildlife.
- 40** French golfer, Jean Van de Velde, appeared to throw away his big chance to win the Open Championship, after giving up what could only be described as an unassailable lead. Most players would have been distraught to have victory snatched from them in such a way. But, interviewed afterwards, Van de Velde pointed out that it was, after all, only a game: There are worse things in life, he said. Really? It may be refreshing to hear a top competitor express such a philosophical attitude, but it also explains fully why the prize eluded him. At that level you have to believe that nothing is worse than losing.

Which one of the following is an underlying assumption of the above argument?

- A** If winning had mattered more to him, Van de Velde would have won.
- B** Anyone can win the top tournaments if they believe they can do it.
- C** Nothing in sport is worse than losing.
- D** Van de Velde was very unlucky in the last stages of the game.
- E** Van de Velde should have cared more about losing.



- 41** Electrical goods retailers often offer 'extended warranties' which guarantee free repairs if the product breaks down during the term of the warranty. Salespeople are keen to persuade customers to buy these warranties because they gain substantial commission from them. Customers may also be tempted to buy them, since they ensure that the purchaser will not be faced with huge repair bills. However, surveys by consumer protection agencies show that the average cost of repairs per customer is less than the average cost of a warranty. Anybody buying electrical goods would, therefore, be well-advised not to buy an extended warranty, as it represents poor value for money.

Which one of the following, if true, would weaken the above argument?

- A** Salespeople knowingly mislead their customers into purchasing a poor value scheme.
  - B** The average cost of repairs is low because for the majority of electrical purchases the actual cost is zero.
  - C** No extended warranty scheme would be viable for the retailer if the average cost of repairs exceeded the cost of the warranty.
  - D** In most warranty agreements there are clauses which state that certain kinds of repair are not covered.
  - E** With or without an extended warranty, customers have statutory rights which retailers are obliged to observe.
- 42** A small mail order company sends out three sizes of parcel in about equal numbers which require postages of 24c, 30c and 72c. They stock stamps in denominations of 6c and 30c and use the minimum number of stamps on each parcel.

What proportion of the two denominations of stamps should the company buy?

- A** 1 x 6c for every 4 x 30c
- B** 1 x 6c for every 1 x 30c
- C** 2 x 6c for every 1 x 30c
- D** 5 x 6c for every 1 x 30c
- E** 11 x 6c for every 2 x 30c

- 43** Every year the 12 local teams that compete for the Tipleby and District Tiddlywinks Trophy are split into two leagues for the purpose of eliminating four of the teams, and sorting out the pairings for the knockout stage of the competition. The table below shows how this is done (QF is Quarter Final).

1st QF	Winners League A v 4th place League B
2nd QF	3rd place League A v Runners-up League B
3rd QF	Winners League B v 4th place League A
4th QF	3rd place League B v Runners-up League A
1st Semi-final	Winners of 1st QF v Winners of 2nd QF
2nd Semi-final	Winners of 3rd QF v Winners of 4th QF

This year's league stage has just been completed, with the following results.

	League A	League B
1st	The Scorpions	The Scales
2nd	The Fish	The Bulls
3rd	The Bearers	The Goats
4th	The Rams	The Archers
5th	The Crabs	The Maidens
6th	The Lions	The Twins

Despite having finished 3rd in their league, the reigning champions, The Goats are still confident of reaching the final.

If The Goats are successful, what are the alternatives as to their prospective opponents in the final?

- A** The Scorpions or The Fish or The Bearers or The Rams.
- B** The Archers or The Bulls or The Rams or The Fish.
- C** The Scorpions or The Archers or The Bearers or The Bulls.
- D** The Scorpions or The Archers or The Scales or The Rams.
- E** The Scorpions or The Twins or The Bearers or The Bulls.

- 44 Jess buys two lengths of carpet in the sales. The carpet is 4m wide and one of the lengths purchased is 4m long while the other is 6m. There is a very pronounced pattern which means that the pieces can only be joined so that the pattern runs the same way. Jess will only accept one join.

In which of Jess's rooms could the carpet be fitted?

A

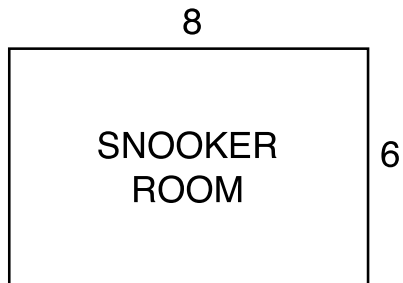

B



C

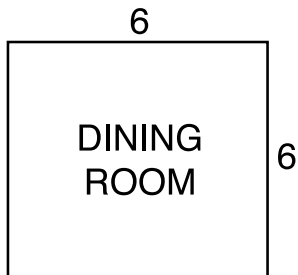

D

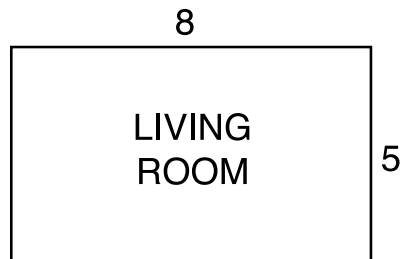

E

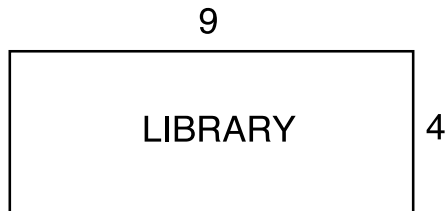

- 45** Over the past few years in parts of the South West, a number of farm animals have been found killed in the fields. The nature of the injuries indicates that a large predator must have been responsible. Local people talk of a number of 'big cats' such as pumas being responsible, claiming that such animals have indeed been seen. Official investigations into these claims have dismissed them, concluding that any sightings have been of domestic rather than of big cats. But these investigations have failed to deal with the point that, even if the sightings can be explained in terms of domestic cats, the injuries on the carcasses of the farm animals cannot be. Big cats such as pumas must be responsible for these attacks.

Which of the following best expresses the main conclusion of the above argument?

- A** Recent attacks on farm animals must have been by big cats such as pumas.
  - B** Sightings of big cats cannot be explained as sightings of domestic cats.
  - C** The injuries on the carcasses of farm animals cannot have been caused by domestic cats.
  - D** There must be a large population of big cats such as pumas in the South West.
  - E** Official investigations into the deaths of farm animals in the South West should have been more thorough.
- 46** If you intend to have a fire you will need dry kindling wood and a firelighter. Unfortunately the kindling wood has been left out in the rain. So, even though you have a firelighter, you will not be able to light the fire.

Which of the following arguments has the same structure as the argument above?

- A** To be sure of catching the train from Paddington, you should have allowed enough time to get to the station and to find the platform. You may get to the station in time but Paddington is very large so you won't be able to find the platform in time. Therefore you are going to miss the train.
- B** To pass your exam you need to be hard-working and intelligent. You have done very little revision and your score in intelligence tests is very low. Therefore you are going to fail your exam.
- C** Your car is below the high tide line and it is stuck in the sand. The tide will be at its maximum height in 30 minutes and the tow truck is not due for 45 minutes. So you are not going to be able to save your car from by the sea.
- D** To get to Nottingham you will either have to go up the motorway or go on the train. The motorway is blocked due to an accident and will not be open for several hours. Therefore you will have to take the train
- E** For breakfast you like to have either toast or cereal. Unfortunately there is no bread and I have just eaten the last of the cereal. So you will not be able to have any breakfast.

- 47** If the government gives financial support for the arts, this means that a proportion of each person's taxes will be used to finance museums and theatres. But some people who pay taxes never set foot in a museum or a theatre and those who do use these services are usually well able to afford to pay for them. Since no one should be forced to subsidise services which they themselves do not use, taxpayers' money should not be used to support the arts.

Which of the following statements is an application of the principle underlying the argument in the passage?

- A** Without support from central government many aspects of the nation's cultural life would be accessible only to the wealthy.
  - B** London's transport system should not be subsidised from taxpayers' money, since some people who pay taxes never visit London.
  - C** Those who can afford private health insurance should nevertheless pay a contribution to the National Health Service.
  - D** Education should be financed from taxpayers' money because it is a service which is beneficial to the nation as a whole.
  - E** If public funding for art galleries were withdrawn and replaced by admission charges, those who were genuinely interested in art would still visit them.
- 48** In a prize weight-lifting competition the winner receives \$100 if he lifts 80kg. He then receives \$10 for the next 5 additional kg, \$15 for the second, and the incremental prize money increases by a further \$5 for each additional unit of 5kg he successfully lifts.

The winner of the competition lifts 110kg.

How much prize money does he receive?

- A** \$ 130
- B** \$ 160
- C** \$ 235
- D** \$ 240
- E** \$ 310

49 The table below shows the expenses by month for a given household.

	Jan	Feb	Mar	Apr	May	Jun	Jul	Aug	Sep	Oct	Nov	Dec	Total
<i>Expenses</i>													
Gas	125			120			80			70			395
Electricity		160			140			80			110		490
Telephone			80			95			110			90	375
Council Tax	60	60	60	60	60	60	60	60	60	60	60	60	720
Coal						80						85	165
Road Tax										125			125
Car Insurance										250			250
Car Maintenance		125						155			285		565
TV Licence									85				85
Logs for Fire			40		40		60						140
House Maintenance			55			225					128		408
Disposable Items	10	10	10	10	10	10	10	10	10	10	10	10	120
Food	200	200	200	200	200	200	200	200	200	200	200	200	2400
Mortgage	320	320	320	320	320	320	320	320	320	320	320	320	3840
House Insurance	240												240
<i>Total Expenses</i>	955	875	765	710	770	990	730	825	785	1035	1113	765	10318

In which month were the energy costs highest?

- A January
- B February
- C April
- D May
- E July

50 Vinod and Sarah are about to move some cube-shaped boxes that have been left in the middle of a store room. The appearance of the boxes from above and the positions of Vinod and Sarah are shown below.

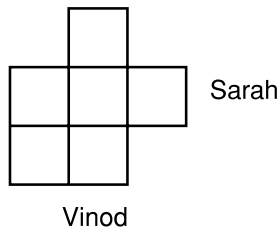

Vinod sees this:

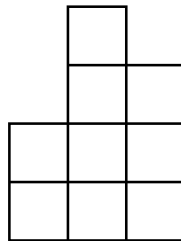

Which of the following **cannot** be the view that Sarah sees?

