

Section A (30 x 2 marks)

Choose the most suitable answer and shade the corresponding oval in the Optical Answer Sheet (OAS) provided.

1.

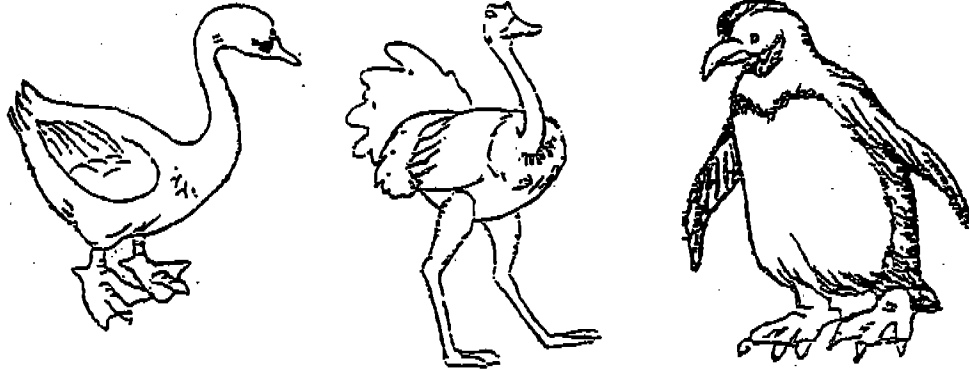

The animals above are classified as birds because all of them _____.

- (A) have a beak
- (B) are able to fly
- (C) have an outer covering of feathers

- (1) B only
- (2) C only
- (3) A and C only
- (4) A, B and C

2. Birds use their bills in nest building, self-defence as well as in feeding. Study the diagrams of the four birds below.

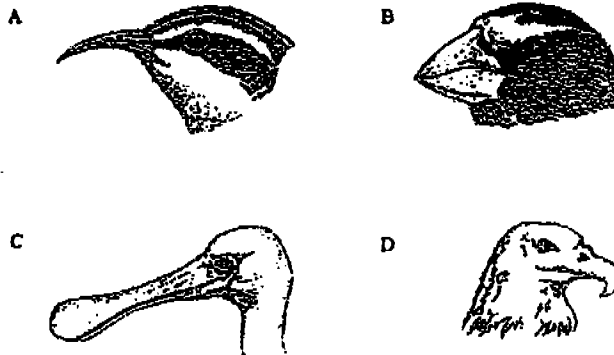

Which of the following shows the food they would most likely feed on?

	A	B	C	D
(1)	nectar	seeds	fish	mice
(2)	mice	fish	seeds	insects
(3)	fish	insects	seeds	nectar
(4)	seeds	nectar	insects	fish

3. Which of the following would occur as a result of deforestation?

- (A) infertile land
- (B) more rain
- (C) more land available for development
- (D) more atmospheric carbon dioxide

- (1) A and B only
- (2) C and D only
- (3) A, C and D only
- (4) A, B, C and D only

4. Study the food web below.

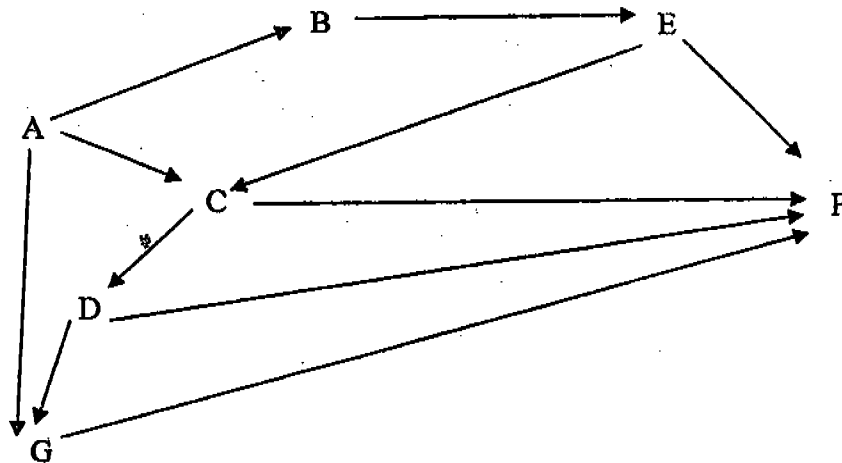

Which of the following statements are true of the food web?

- (A) A and G are food producers
- (B) C and G are omnivores
- (C) D and E are both preys and predators
- (D) F is the prey of G

- (1) A and B only
- (2) B and C only
- (3) A, B and C only
- (4) B, C and D only

5.

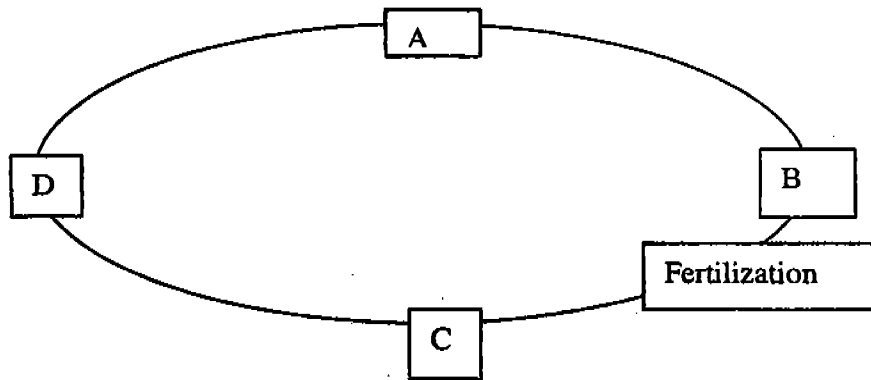

The diagram shows the life cycle of an animal and the point at which fertilization occurs. Which of the following are correct stages of the life cycle?

	A	B	C	D
(1)	Egg	Larva	Pupa	Adult
(2)	Larva	Pupa	Adult	Egg
(3)	Pupa	Adult	Egg	Larva
(4)	Adult	Egg	Larva	Pupa

6. The diagram below shows how blood is circulated in our body. Which one of the following correctly shows the amount of oxygen in our blood at A, B, C and D?

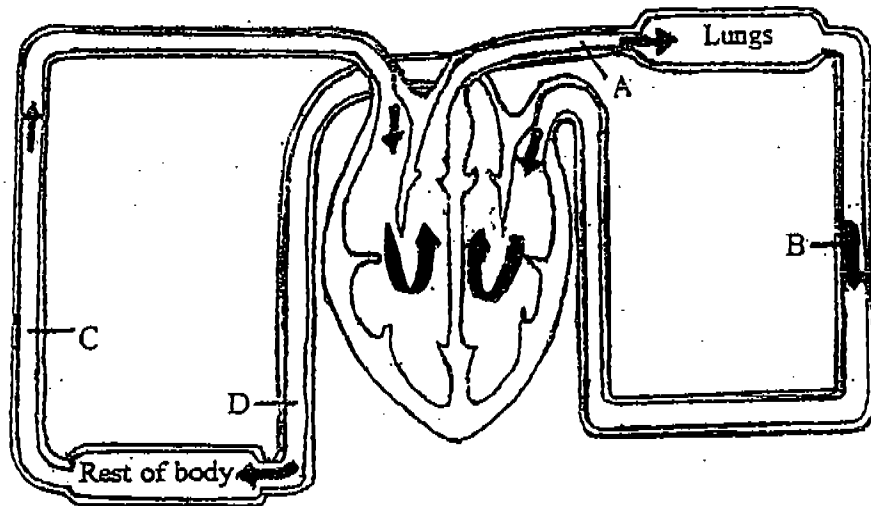

	Less oxygen at	More oxygen at
(1)	A and B	C and D
(2)	A and C	B and D
(3)	B and C	A and D
(4)	B and C	A and B

7. Which of the following statements about bacteria is/are true?

- A: Bacteria cannot be seen by the naked eye but they are all around us.
- B: Bacteria can be used to prepare some food materials.
- C: Bacteria is used to treat sewage.
- D: Bacteria cause metals to rust in water.

- (1) A only
- (2) A and D
- (3) A, B and C
- (4) B, C and D

8. The animal below constantly sucks in water and opens and closes part X.



It does this so that it can _____

- (1) keep its eggs inside its mouth
- (2) drink in water from its surroundings
- (3) swallow dissolved nutrients in the water
- (4) breathe in the dissolved oxygen in the water

9. The diagram below shows the stages in the reproduction of the amoeba.

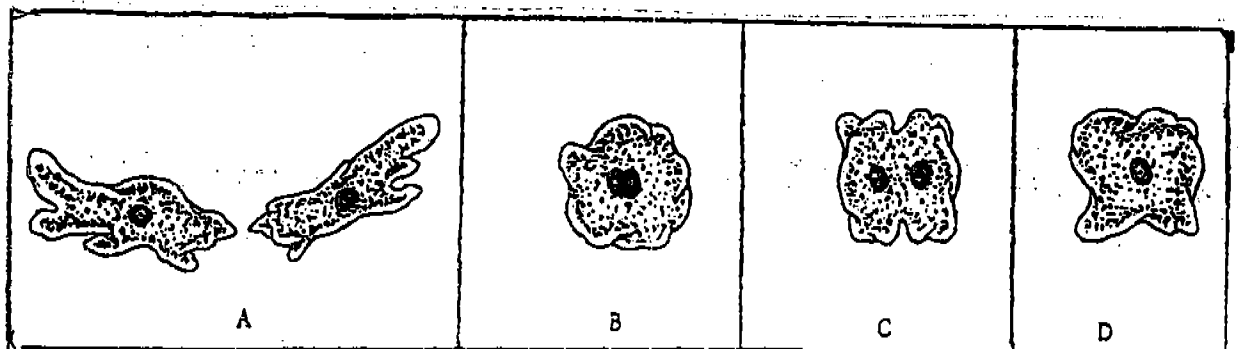

Arrange its stages of reproduction in the correct sequence.

- (1) ABCD
- (2) DCAB
- (3) DBCA
- (4) CADB

12. The table below shows what four vases A, B, C and D contain.

Vase	Number of stalks of flowers	Amount of Chemical X (mg)	Amount of water (ml)
A	1 stalk	2	100
B	none	2	100
C	1 stalk	none	100
D	1 stalk	none	none

Larry wants to find out whether chemical X helps to keep flowers fresh for a longer time. Which two vases should Larry compare in order to find this out?

- (1) A and B
(2) A and C
(3) B and C
(4) B and D
13. The jelly-like substance that surrounds the eggs of a frog helps prevent the eggs from _____.

- A: being eaten by other animals
B: sinking to the bottom of the pond
C: sticking together

- (1) A only
(2) A and B only
(3) A and C only
(4) B and C only

14. Which statements about the papaya plant and the Bird's nest fern below are correct?

- (A) They have edible parts.
(B) They are food producers.
(C) They bear flowers and leaves.
(D) They have poisonous leaves.
(E) They reproduce in different ways.

- (1) B and D
(2) B and E
(3) A, C and E
(4) B, D and E

15. An experiment was set up as shown below to find out the effect of light intensity on the rate of photosynthesis of some hydrilla plants. The number of bubbles produced per minute is counted.

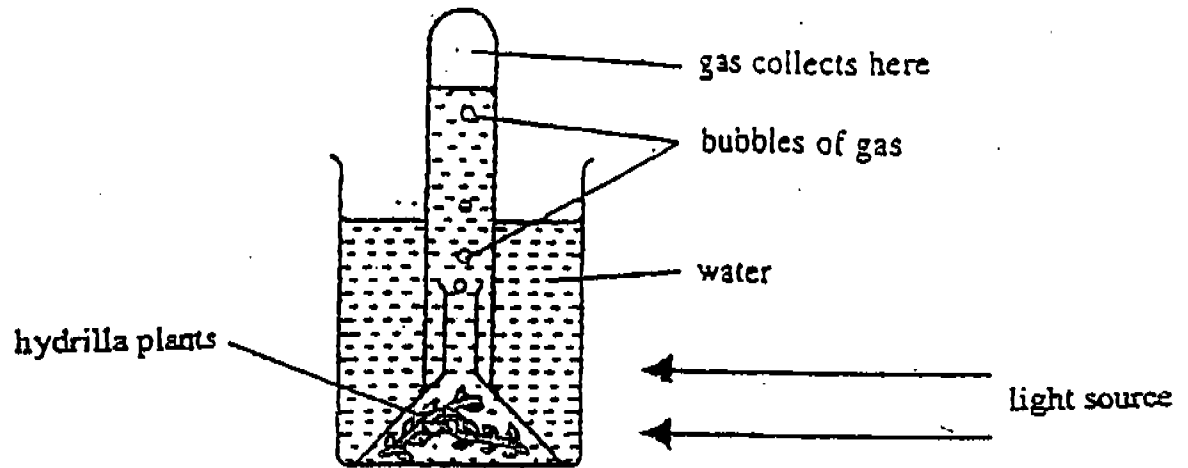

The results produced are plotted on a graph as shown below.

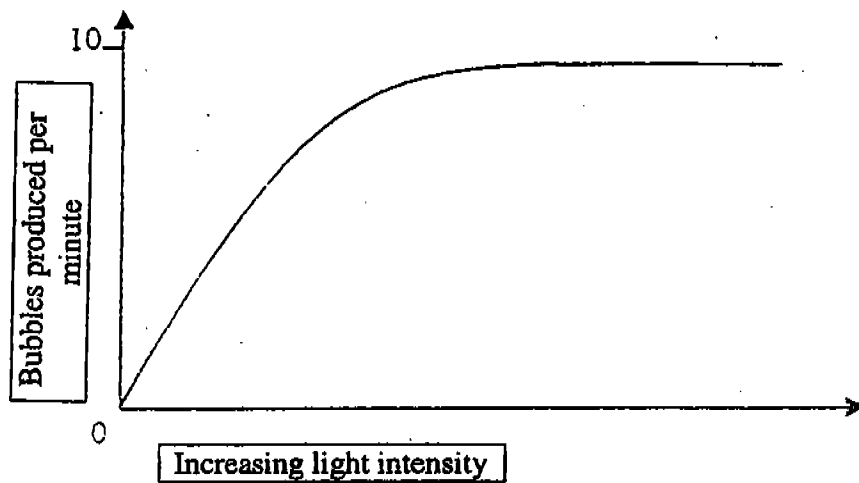

Which one of the following statements best describes the graph above?

- (1) As the light intensity increases, the number of bubbles produced per minute also increases.
- (2) The light intensity depends on the number of bubbles produced.
- (3) The rate of photosynthesis slows down when the light is too bright
- (4) The number of bubbles produced eventually reaches an optimum in spite of increasing light intensity.

16. Plastic is a more suitable material for making milk bottle for babies than glass because _____.

- A: it is transparent.
- B: it does not break easily
- C: it is lighter than glass

- (1) A and B only
- (2) A and C only
- (3) B and C only
- (4) A, B and C

17. May held a bar magnet above a paper clip which was tied to a weight by a string. The magnet pulled the paper clip up. Then she placed four items, one at a time, between the magnet and the clip and observed if the paper clip dropped or remained where it was.

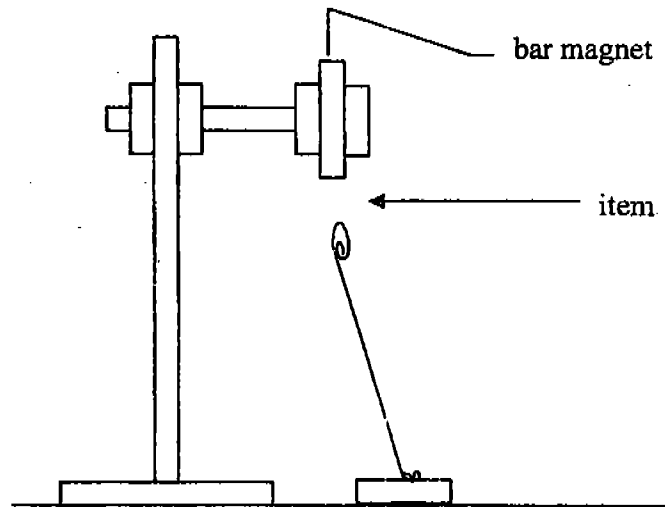

If the four items used in this experiment were a thin sheet of steel, a piece of aluminium foil, a piece of paper and a thin sheet of silver respectively, which one of the following would show accurately what May had observed?

	Steel	Aluminium Foil	Paper	Silver
(1)	Dropped	Dropped	Remained	Dropped
(2)	Dropped	Remained	Remained	Remained
(3)	Remained	Remained	Dropped	Remained
(4)	Remained	Dropped	Dropped	Remained

18. Study the diagram below carefully.

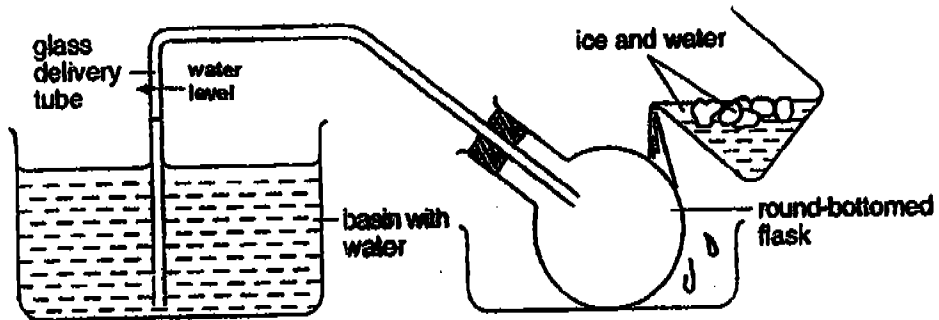

What will happen to the water level in the delivery tube when the water from the beaker is poured on the exterior of the round-bottomed flask? It will _____.

- (1) fall (2) rise
 (3) fall and then rise (4) rise and then fall

19. The diagram below shows the behaviour of substance X when the container is placed in different positions.

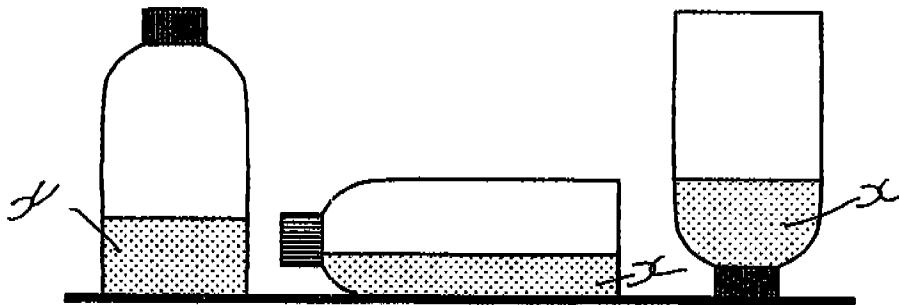

Based on what you can see only, which of the following statements is/are definitely true?

- A: X is a gas.
 B: X is mercury.
 C: X does not have a definite shape
 D: X occupies space
- (1) A and C only (2) B and D only
 (3) C and D only (4) B, C and D

20. Humidity is a measure of the amount of water vapour in the air. Which one of the following graphs correctly shows the effect of increased humidity on the rate of evaporation of water?

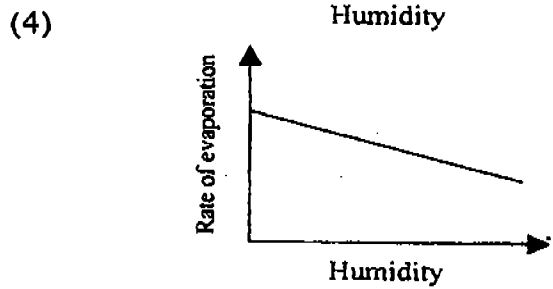
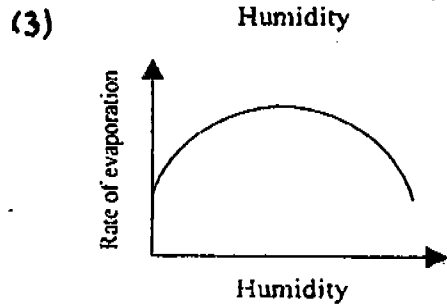
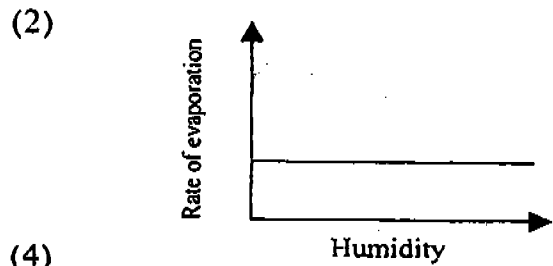
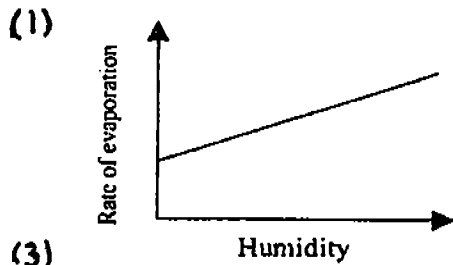

21. A torch was used to shine at an opaque cone from four different directions as shown below.

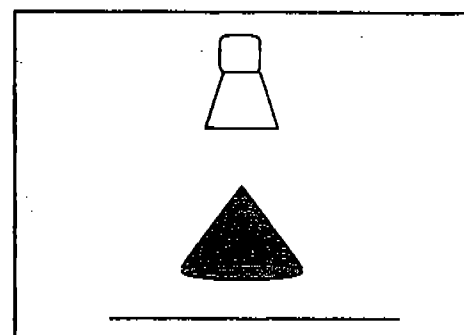
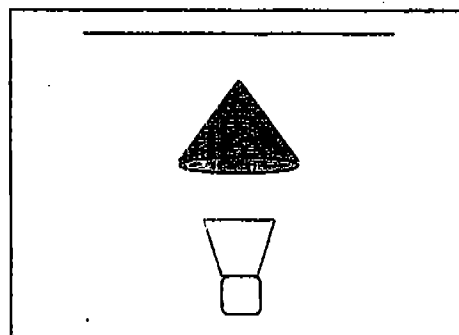
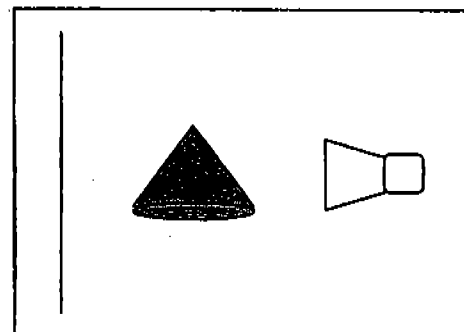
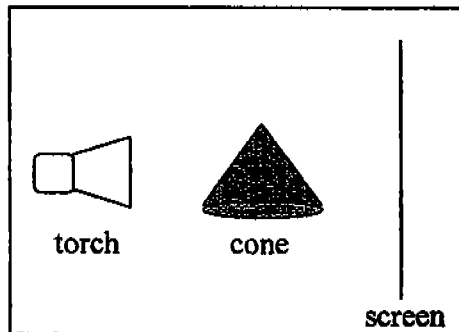

How many different types of shadow can be found on the screen? (Ignore the difference in size)

- (1) 1 (2) 2
 (3) 3 (4) 4

22. The experiment shown below was carried out in a dark room. Sheets A, B, C and D were arranged in a straight line.

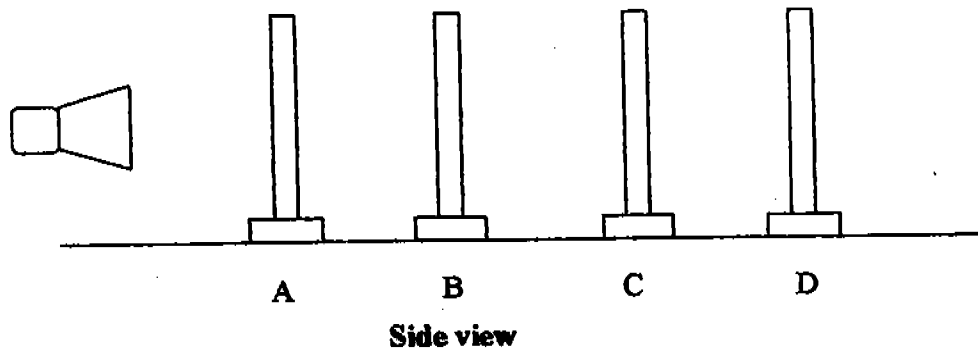

A heart-shaped hole was found on sheet A as shown below.

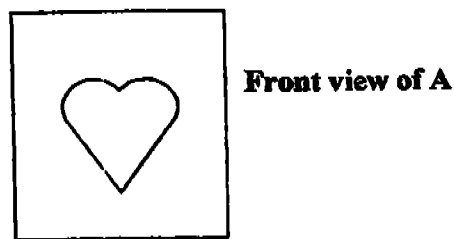

When the torch is switched on, a bright heart-shape was seen on sheet C only.

Which one of the following correctly describes the properties of the materials that sheets A, B, C and D are made of?

	Transparent	Opaque	Not possible to tell
(1)	A	C	B and D
(2)	A	C and D	B
(3)	B	A and C	D
(4)	A and B	C	D

- 23 Which of the following processes involve the loss of heat from water?

A: Evaporation
 B: Condensation
 C: Melting
 D: Freezing

- (1) A and C only (2) A and B only
 (3) B and C only (4) B and D only

24. Four beakers of water at 27°C were heated to boiling using different numbers of burners. The time taken for the water in beaker C to boil was 30 minutes.

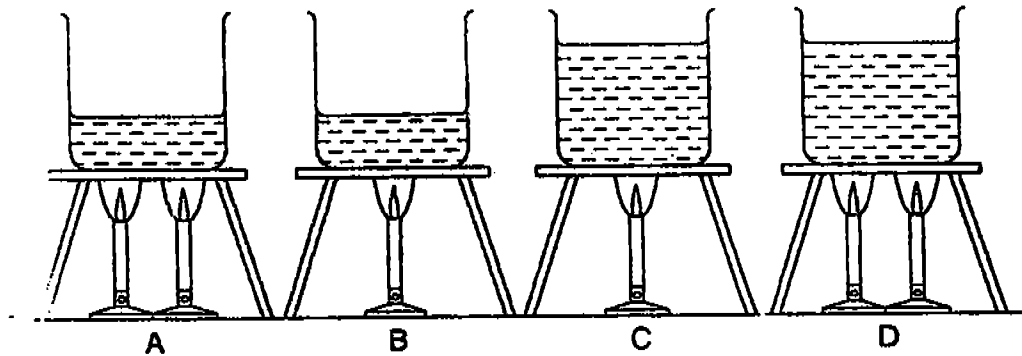

Which of the following statement(s) is/are true about the above set-ups?

- A: The water in beaker A took the shortest time to boil.
B: All the water in the beakers reached 100°C after 30 minutes.
C: The water in each beaker only began to evaporate when its temperature reached 100°C .

- (1) A only
(2) B only
(3) A and B only
(4) A, B and C

25. When the earth has completed 1 revolution about the sun, it would also have rotated _____ times about its own axis.

- (1) 1
(2) 24
(3) 28
(4) 365

26. The diagram below shows four types of lever.

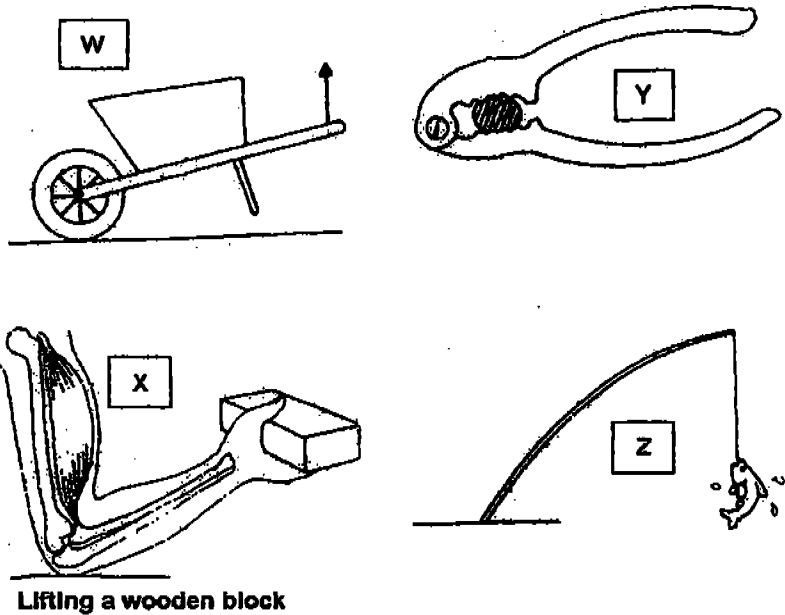

Which of the above levers enable work to be done more quickly?

- | | |
|-------------|-------------|
| (1) W and X | (2) W and Y |
| (3) X and Z | (4) Y and Z |

27. Four bulbs and a bell are connected in a circuit as shown below.

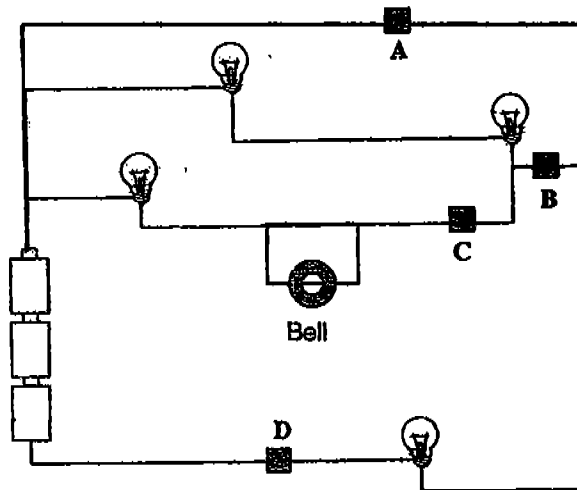

In the circuit above, at which position (A, B, C or D) should the switch be opened in order for only one bulb to be lighted?

- | | |
|-------|-------|
| (1) A | (2) B |
| (3) C | (4) D |

28. Study the classification chart below carefully.

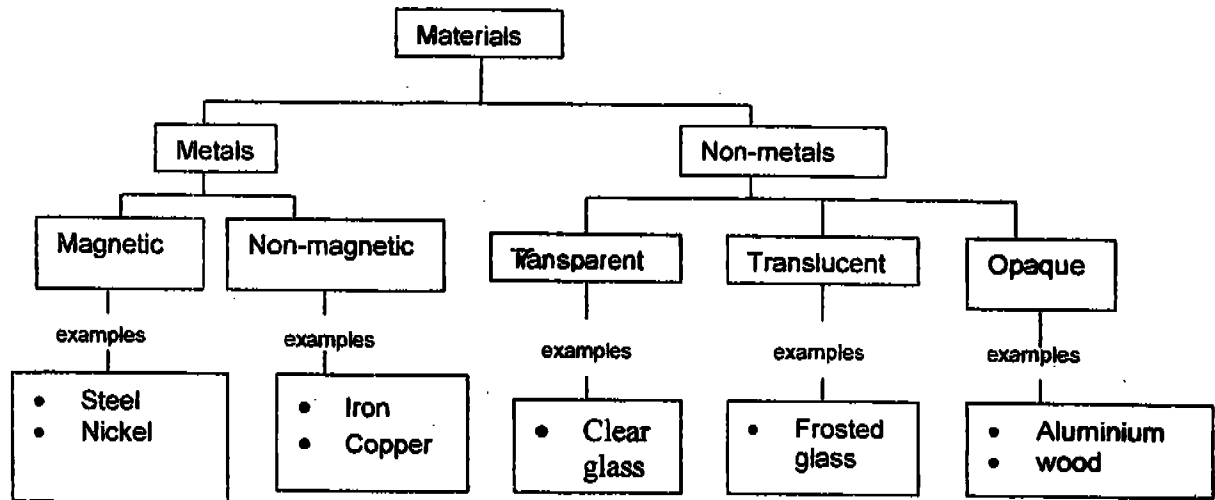

Which of the above materials are wrongly classified?

- (1) Nickel, iron and copper.
- (2) Iron, copper and aluminium
- (3) Nickel and frosted glass
- (4) Iron and aluminium

29. In an experiment, 5cm^3 of a liquid, is applied on a curved surface shown below. When a metal ball is released from Point X of the curved surface, the ball will roll up and down along the surface for a few times before it comes to rest at Y. The time taken for the ball to come to rest is noted down.

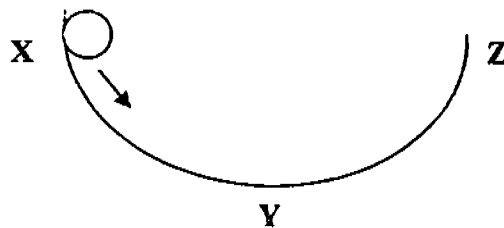

The experiment is repeated with three other liquids, B, C and D, to find out which liquid is the best lubricant. The results are recorded in the table below.

Liquid	Time taken for the ball to come to rest (sec)
A	8
B	5
C	13
D	11

Which liquid is the best lubricant?

- (1) A
- (2) B
- (3) C
- (4) D

Index Number

--	--	--	--	--	--	--	--	--	--	--

NAN HUA PRIMARY SCHOOL
PRIMARY SIX PRELIMINARY EXAMINATION 2004
SCIENCE
BOOKLET B

Name: _____

Class: Primary 6 _____

Date: _____

DO NOT OPEN THIS BOOKLET UNTIL YOU ARE TOLD TO DO SO.

30. A ball was rolled down a slope from P to Q as shown in the diagram below.

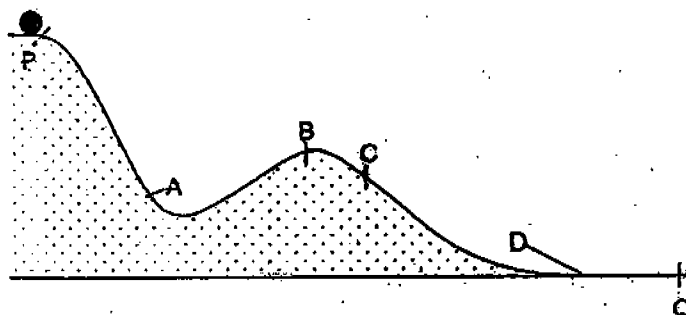

At which marked points on the slope did the ball possess the greatest potential energy and the greatest kinetic energy respectively?

	Greatest potential energy	Greatest kinetic energy
(1)	B	A
(2)	B	C
(3)	C	A
(4)	A	D

SECTION B (40 MARKS)

Write your answers to questions 31 – 46.

31.

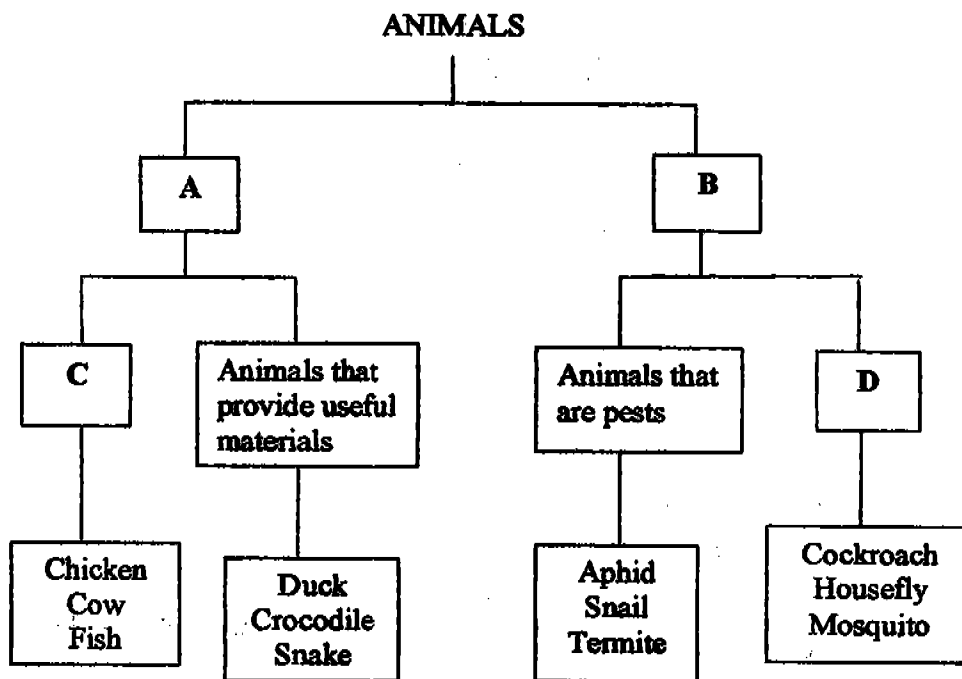

In the above classification table, what headings can be written at A, B, C and D? (4m)

A: _____

B: _____

C: _____

D: _____

32. Study the food web below and answer the questions that follow.

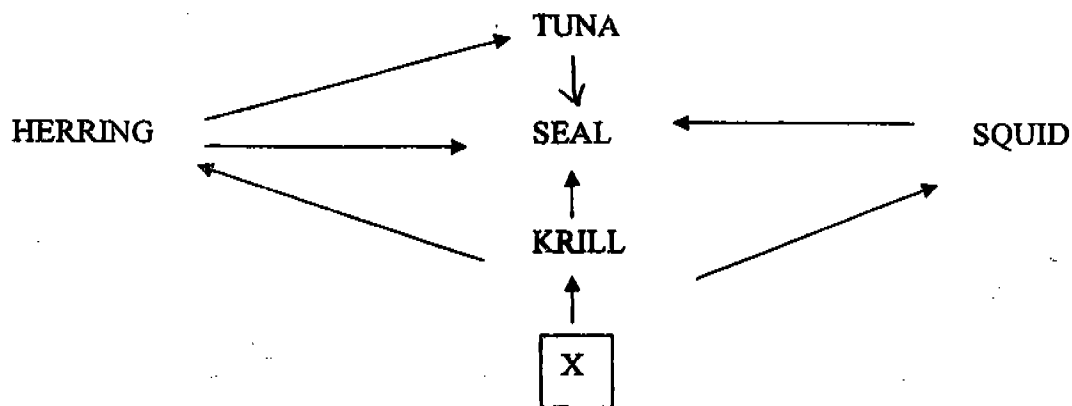

(a) If the number of seals is reduced, which population will increase the most? (1m)

(b) What possible organism can X be? (1m)

33. Sherwin learnt from the Internet that some cell types can be cultured (grown) in plastic containers. He saw a magnified diagram of some of these cells shown below.



(a) Name the instrument that is used to examine these cells. (1m)

(b) Sherwin thinks that these cells are plant cells because the cells seem to have a regular shape. State the two cell parts that are present in plant cells but are absent in animal cells. (2m)

34. Study the food relationship shown below.

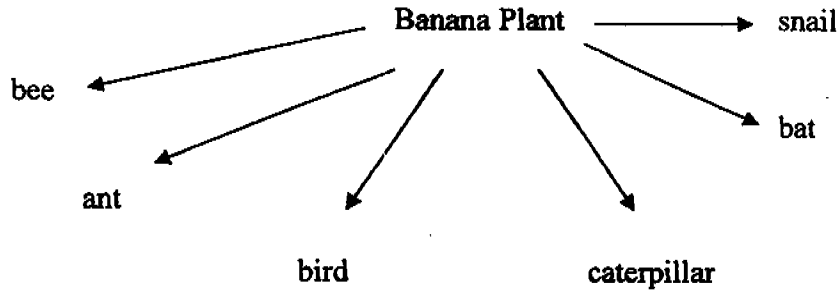

(a) Name the type of community where such food relationships can be found. (1m)

(b) The producer in the above community supports many food consumers. How is competition for food among these animals prevented? (1m)

35. Grass which grows on a vegetable plot is considered harmful while the same type of grass which grows on a hill slope is considered useful.

(a) Why is grass grown on a vegetable plot considered harmful? (1m)

(b) Why is grass grown on a hill slope considered useful? (1m)

36. This diagram shows our digestive system.

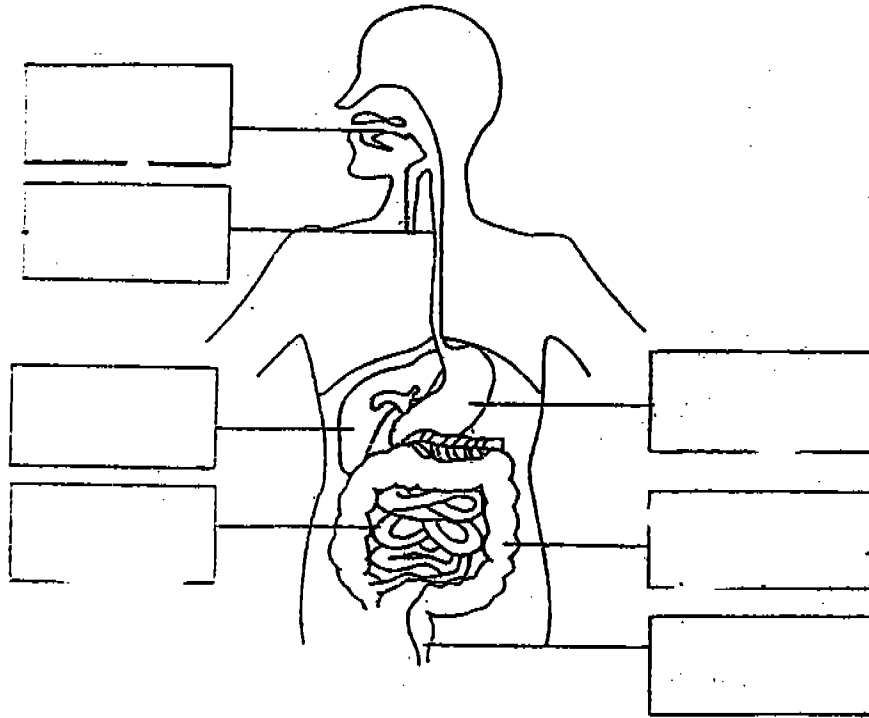

the appropriate boxes in
(a) Label the diagram above:

- (i) all three parts where digestion of food occurs.
- (ii) the part where absorption of large amounts of water occurs. (2m)

(b) What happens to our food during digestion? (1m)

37.

Diagram A

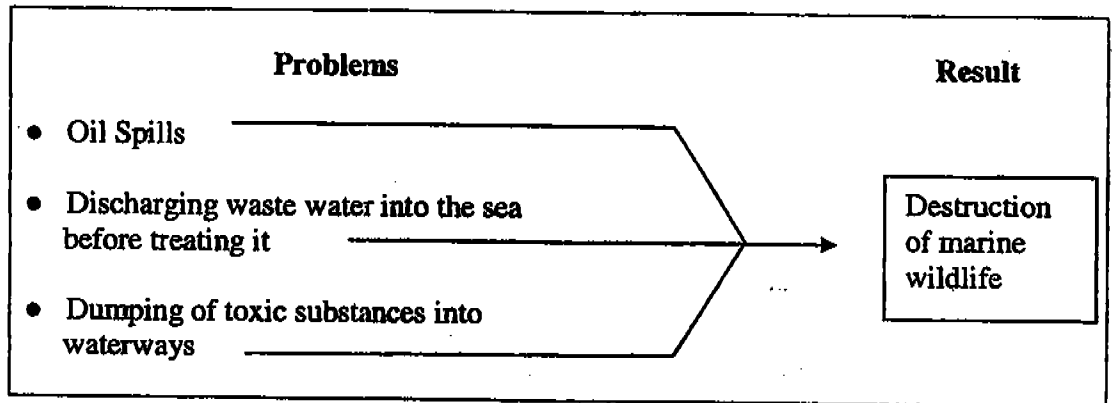

- a. Study Diagram A carefully and complete Diagram B (shown below) accordingly. Fill in the result in Box X. (1m)

Diagram B

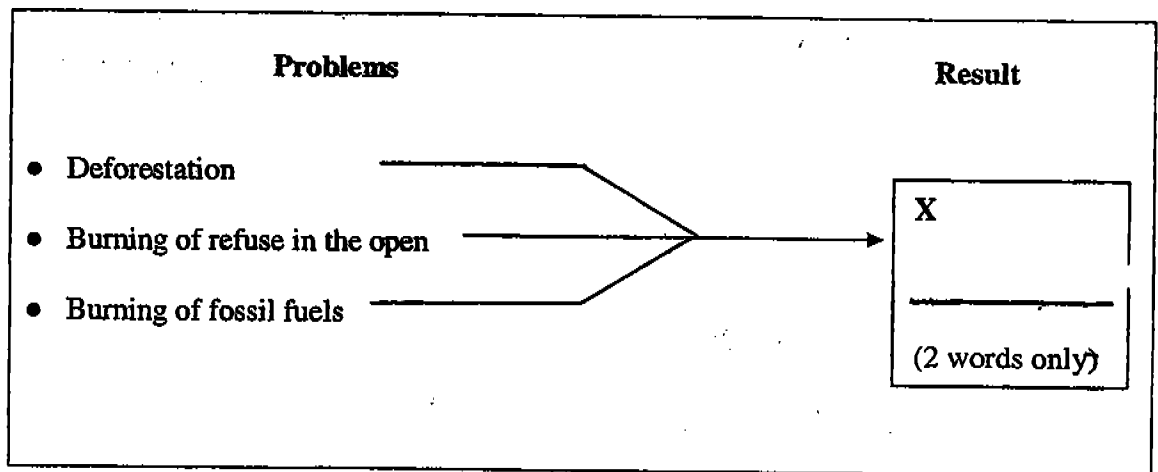

- (b) X could have disastrous effects. State one such effect. (1m)

38. The table below shows the characteristics of 7 types of rats.

Characteristics	RAT						
	A	B	C	D	E	F	G
Pointed ears	√	x	x	√	√	√	√
Whiskers longer than ears	√	x	√	x	x	x	√
Straight tail	√	√	√	√	√	x	√
Curved claws	x	x	√	√	x	√	x
Long fur	√	√	√	√	x	x	x
Fur on underside of tail	√	√	x	√	x	x	√
Tail longer than body	x	√	x	x	√	√	x

Key: √ Characteristic is present in rat
 x Characteristic is absent in rat

- (a) Which of the 6 rats has characteristics that are most similar to Rat A? (1m)

- (b)

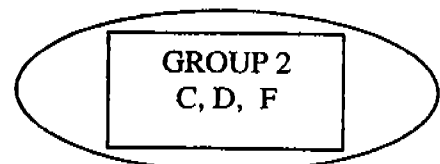
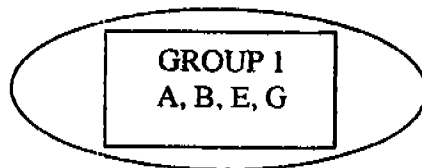

Which characteristic is used to classify the rats into the 2 groups above? (1m)

39. Leena was given three magnets of different sizes, a paper clip and a ruler.

(a) What must she measure to compare the strength of the three magnets? (1m)

(b) How can she tell which bar magnet has the strongest magnetism? (1m)



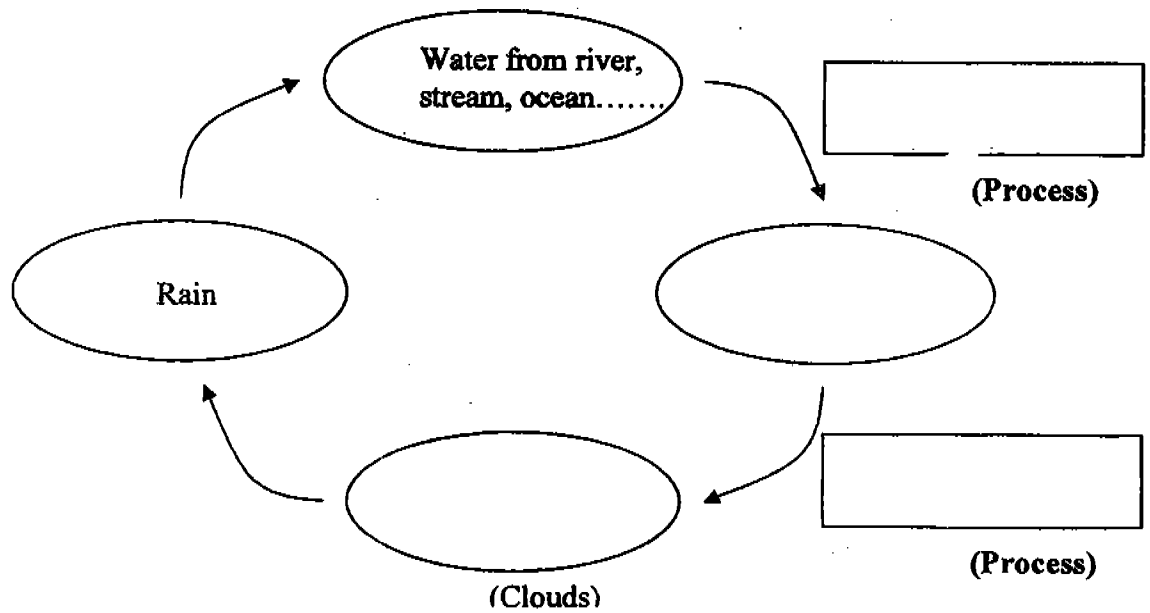

40. The diagram below shows the water cycle. Fill in the boxes with appropriate words ^{and words} (2 m)

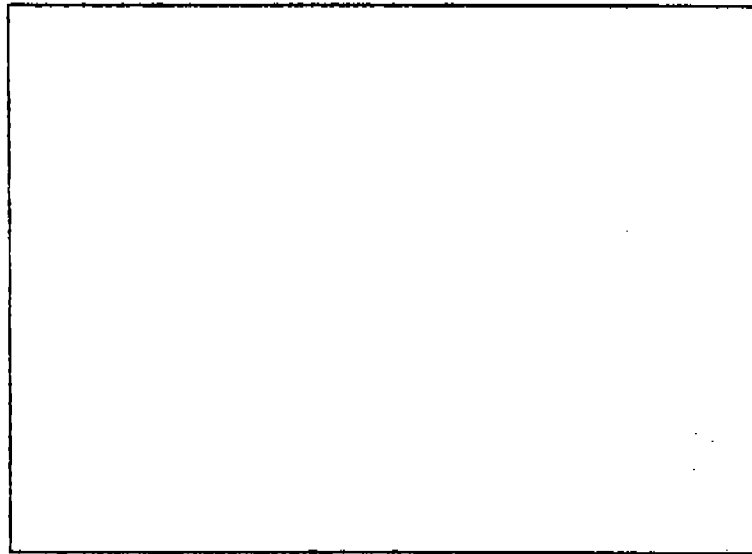

41. (a) Why does the sun appear to move across the sky from the east to the west every day? (1 m)

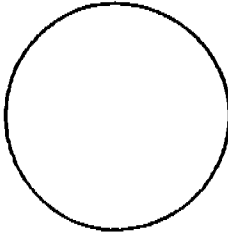
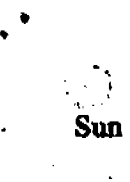
(b) The diagram below shows the Sun, the Earth and the Moon. Draw the paths taken by the Earth and Moon in space. Use the key provided as a guide. (2 m)



Key	
	 Sun
	Earth
	Moon
	Path taken by the Earth
	Path taken by the Moon

42. (a) The diagram below shows a man lifting a 50 kg load using different methods.

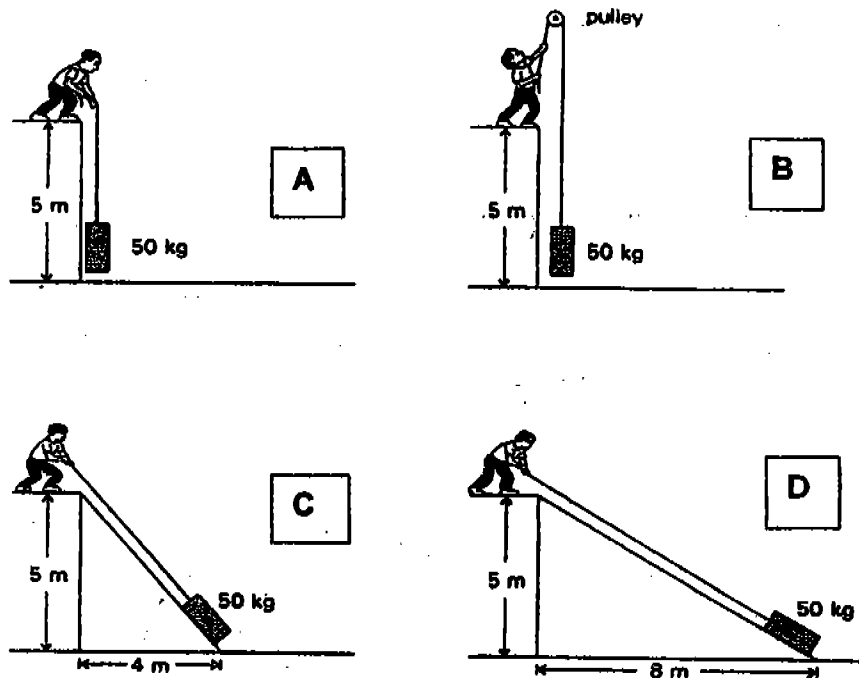

Assuming that there is a small amount of friction when the fixed pulley is used, arrange the above methods in **increasing order of the effort used.** (1 m)

(b) The diagram below shows the pedal of a bicycle.

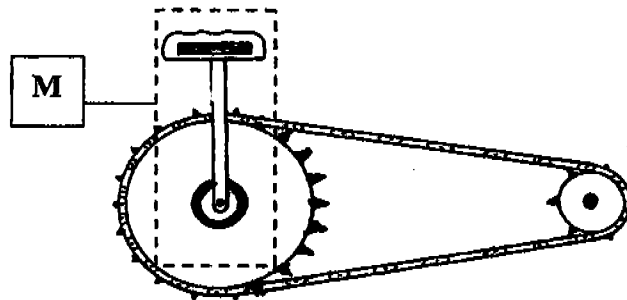

(i) Identify the type of simple machine marked M. (½m)

(ii) State one way how the part marked M helps us to do work. (½m)

c) Study the diagrams below carefully.

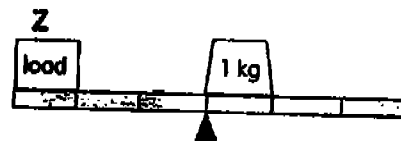
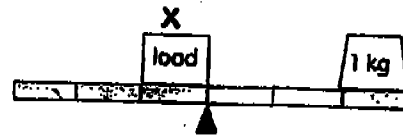
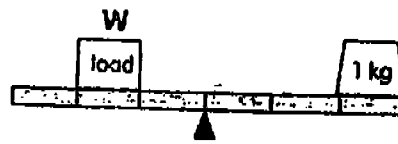

Arrange the masses of the loads from the heaviest to the lightest. (1m)

43. The diagrams below show some batteries and bulbs.

Using not more than 4 wires each, connect the battery to the bulbs such that:

- all the bulbs light up.
- the bulbs in arrangement P are brighter than those in arrangement Q.

(2 m)

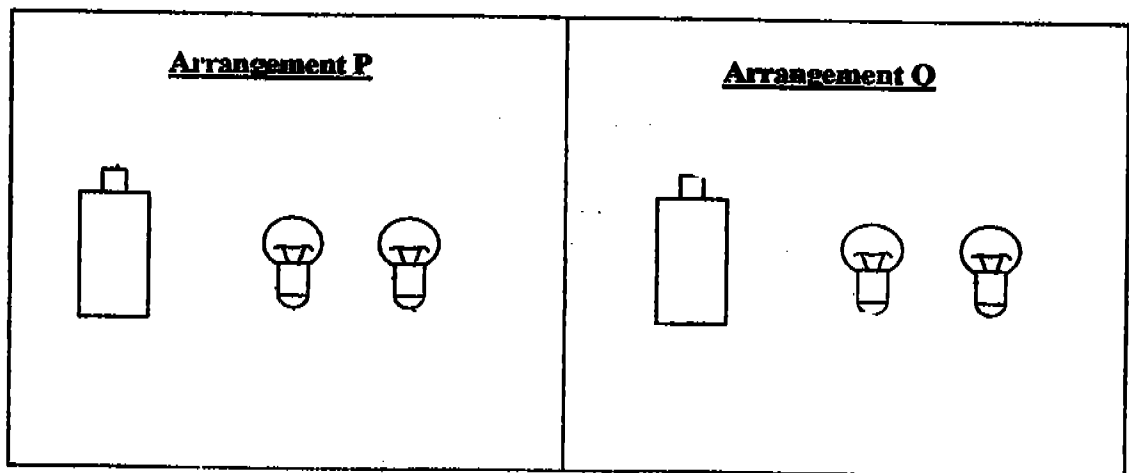

44. Study the flow chart below carefully.

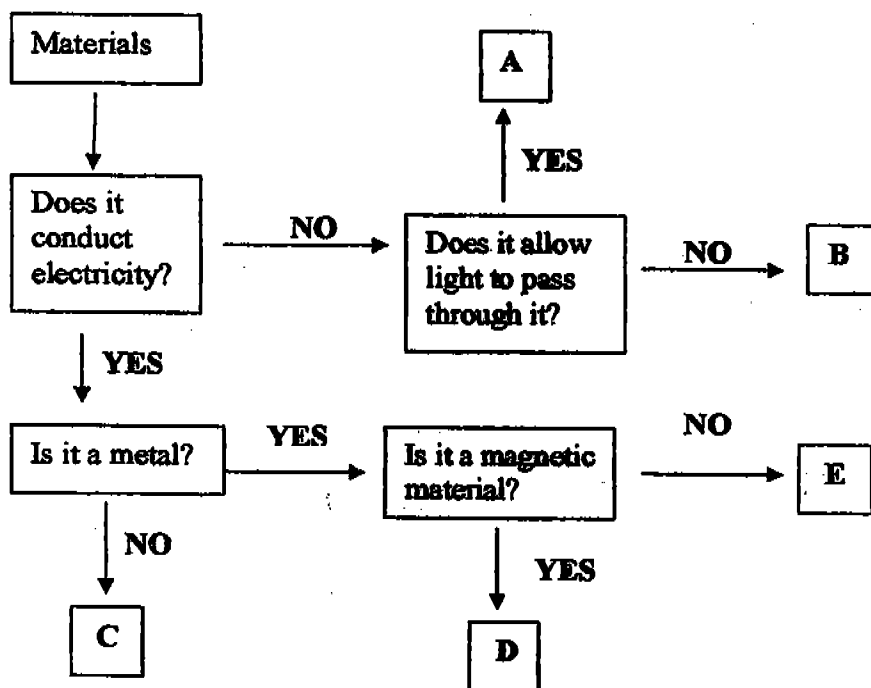

a) What common properties do materials **D** and **E** have? (1m)

b) Which letter **A**, **B**, **C**, **D** and **E** best represents the material "carbon"? (1m)

45 Mary set up a pendulum as shown below.

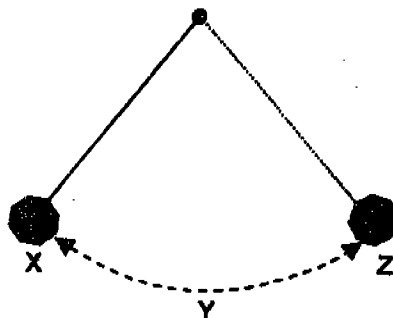

She carried out the experiment as stated below:

- (I) Release the metal ball of mass 50g at position X.
- (II) Count and record the number of swings made by the metal ball in a minute.
- (III) Repeat steps (I) and (II) twice to find the average number of swings made by the ball in a minute.
- (IV) Repeat Steps (I) to (III) using metal balls of mass 100g and 150g respectively.

a) What is the aim of Mary's experiment? (1m)

The result of Mary's experiment is shown below.

Mass of metal ball (g)	50	100	150
Average number of swings per minute	20	21	20

b) What conclusion can Mary draw based on the above result? (1m)

c) What is the energy conversion from point X to Y to Z? (1m)

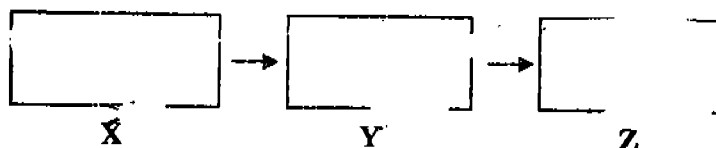

46. The graph below shows the time taken for a toy car to come to a stop when it was rolled over two surfaces, P and Q.

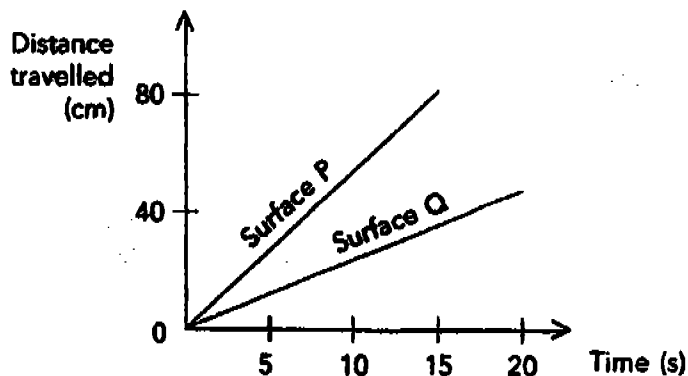

- a) Which surface has more friction? (1m)

- b) What can be done to reduce the friction of the two surfaces? (1m)

- b) The diagram below shows the toy car moving on surface P. Draw an arrow in the box provided to show the direction of frictional force between the car wheel and the ground. (1m)



~~~~~End of Paper~~~~~

Have you checked your answers?

NAN HUA PRIMARY SCHOOL  
 PRIMARY SIX PRELIMINARY EXAMINATION 2004  
 SCIENCE

SA 2

- 1) 3            28) 4  
 2) 1            29) 3  
 3) 3            30) 1  
 4) 2            31) A : Vertebrates  
                   B : Invertebrates  
                   C : Animals that we can eat.  
                   D : Animals that carry germs.  
 5) 3  
 6) 2  
 7) 3  
 8) 4            32) a) Tuna  
                   b) phytoplankton, plankton  
 9) 3  
 10) 1           33) a) Microscope  
                   b) Cell wall and chloroplast  
 11) 1  
 12) 2           34) a) Single tree community  
                   b) They feed on differnt parts of the Banana plant.  
 13) 3  
 14) 2           35) a) The grass will compete with the vegetable with  
                   water, nutrients, sunlight and space.  
                   b) The roots of the grass hold the soil preventing  
                   soil erosion/land slides.  
 15) 4  
 16) 3  
 17) 2           36) mcunt  
                   -----  
                   -----                    stomach  
                   small intestine                large intestine  
                   -----  
                   b) It is broken down into simpler substances.  
 18) 3  
 19) 3  
 20) 4  
 21) 2  
 22) 3           37) a) Air pollution  
                   b) Greenhouse effect  
                   Rising temperatures in the world  
                   Melting of polar ice cause flooding.  
                   Fraak weather conditions that cause destruction.  
 23) 4  
 24) 3  
 25) 4  
 26) 3           Air pollution  
 27) 2           Acid rains that destroy plants and pollute lakes

- 38) a) Rat 3  
 b) Whether have curved claw or do not have curved claw.
- 39) a) She must measure the maximum distance between the magnet and the clip that they can still be attracted.  
 b) The magnet that can attract the most items.

- 40) Evaporation  
 Water Vapour  
 Condensation  
 Water droplets

- 41) a) The rotation of the earth round its axis from west to east.

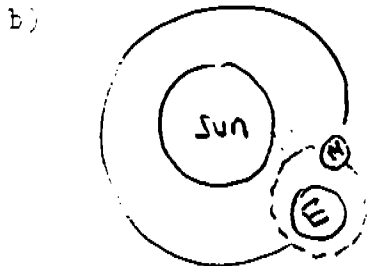

- 42) a) D, I, A, B  
 b) i) Wheel and axle  
 ii) It reduces the effort needed to move the load.  
 c) X, W, Y, Z

43)

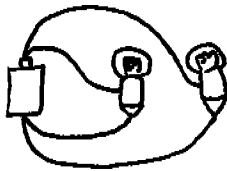

- 44) a) Both conduct electricity and are metals  
 b) C
- 45) a) The aim is to see whether the different mass of metal ball will affect the number of swings.  
 b) The mass of the ball does not affect the number of swings made by the pendulum.
- 46) a) Surface C  
 b) Put oil or grease to reduce the friction of the two surface.