

NANYANG PRIMARY SCHOOL

PRIMARY SIX SCIENCE

SEMESTRAL ASSESSMENT 1

2006

BOOKLET A

Date : 8th May 2006

Duration : 1 h 45 min

Name : _____ ()

Class: Primary 6 ()

Marks Scored:

Booklet A:	60
Booklet B :	40
Total :	100

Parent's signature:
CHECKED 1 8 MAY 2006

DO NOT OPEN THIS BOOKLET UNTIL YOU ARE TOLD TO DO SO.
FOLLOW ALL INSTRUCTIONS CAREFULLY.

Booklet A consists of 16 printed pages including this cover page.

Section A (30 x 2 marks = 60 marks)

For each question from 1 to 30, four options are given. One of them is the correct answer. Make your choice (1, 2, 3 or 4). Shade the correct oval (1, 2, 3 or 4) on the Optical Answer Sheet provided.

1. An old lady commented after observing a fruit, "This yellow fruit is both soft and fragrant".
Which of the following senses did she use?

- A. Sight
- B. Smell
- C. Touch

p3: sense 5

- (1) A and B only
- (3) B and C only

- (2) A and C only
- (4) A, B and C

2. Which of the following systems work together to enable Mary to play a game of squash?

- A circulatory system
- B muscular system
- C respiratory system
- D skeletal system

- (1) A and C only
- (3) A, B and D only

- (2) B and D only
- (4) A, B, C and D

3. Ceramic is similar to glass because they are _____.

- A brittle
- B hard
- C opaque
- D poor conductors of heat.

- (1) A and D only
- (3) A, B and D only

- (2) B and C only
- (4) A, C and D only

4. Study the classification table below.

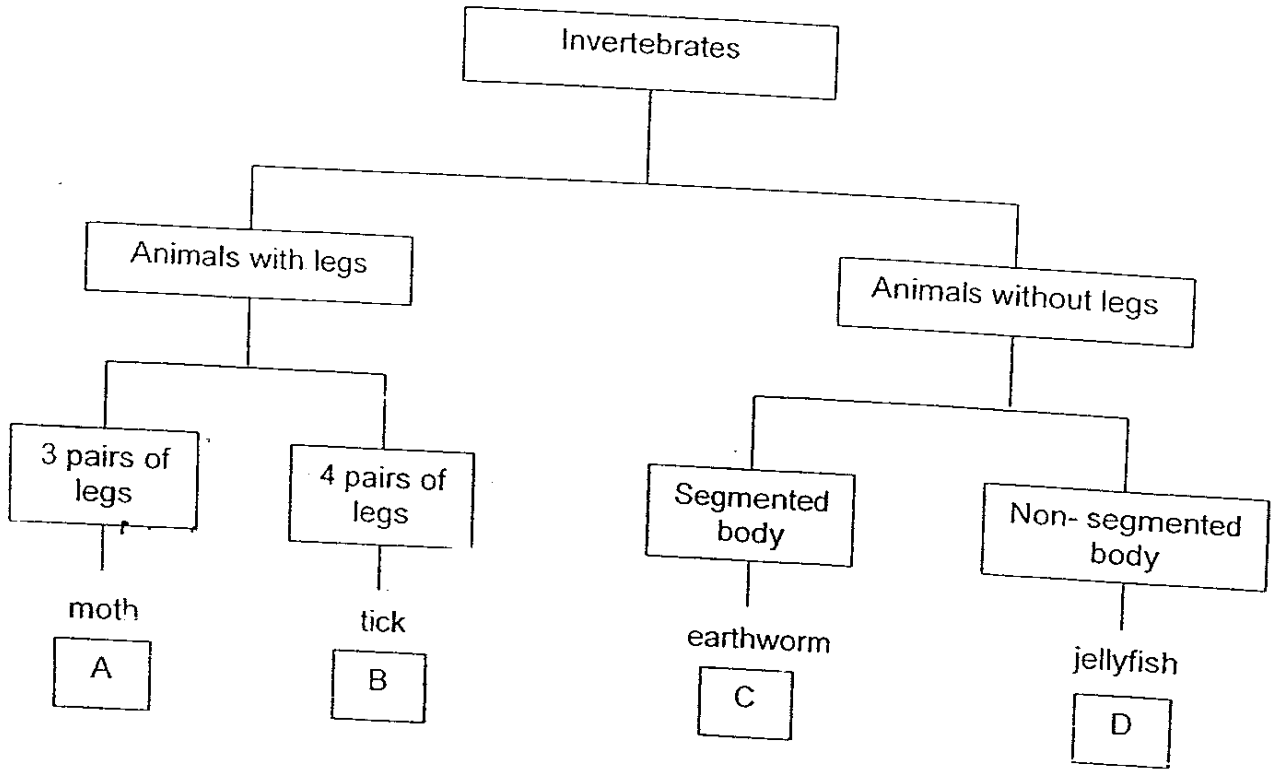

Which of the following best represent organisms A, B, C and D?

	A	B	C	D
(1)	cockroach	crab	slug	octopus
(2)	grasshopper	centipede	prawn	starfish
(3)	housefly	leech	caterpillar	sponge
(4)	termite	spider	millipede	coral

Pech

5. Which one of the following groups consists of a solid, a liquid and a gas at room temperature?

- (1) candy, milk, bread
- (2) hammer, steam, wine
- (3) nitrogen, petroleum, kerosene
- (4) wax, mercury, butter

6. Study the diagram below.

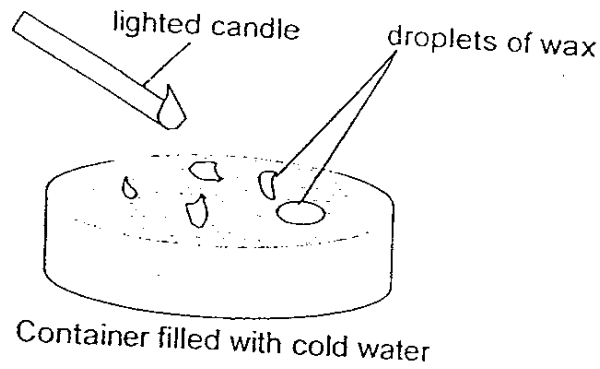

Which of the following statements are true about the droplets of wax when they land on the water surface?

- A They gain heat.
- B They lose heat.
- C They change state.
- D They become a transparent substance.

- (1) A and C only
- (2) A and D only
- (3) B and C only
- (4) C and D only

7. Which one of the following statements about energy is false?

- (1) Energy has no mass.
- (2) Energy occupies space.
- (3) Energy cannot be created.
- (4) Energy can be obtained from food.

8. In which of the following situation/s is/are friction useful?

- A. A match lights up when struck.
 - B. Shoes and tyres become worn out with use.
 - C. A bicycle slows down when the brakes are applied.
- (1) A only
 - (2) A and B only
 - (3) A and C only
 - (4) B and C only

9. Which one of the following matter underlined below possesses kinetic energy?

- (1) The waves splashing on a beach.
- (2) A boulder resting on a steep cliff.
- (3) The solidified lava from a volcano.
- (4) A boy about to hit a ball with his bat.

10. The diagram below shows a bimetallic strip made of iron and brass.

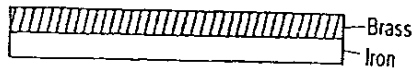

The bimetallic strip is then heated for 30 minutes. Given that brass expands more than iron, which one of the following diagrams shows the bimetallic strip after it has been heated?

(1)

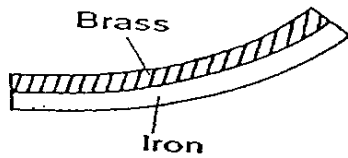

(2)

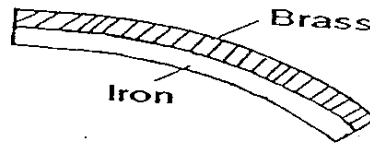

(3)



(4)

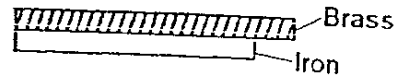

11. The table below shows the length of a spring when different loads were hung on it.

Load (g)	Length of spring (cm)
20	8
60	10
120	13
160	15

What was the original length of the spring?

- (1) 4 cm
(3) 6 cm

- (2) 5 cm
(4) 7 cm

12. The diagram shows a flask and a basin of boiling water. The flask was filled with coloured water. When the flask was lowered into the boiling water, it was observed that the water level in the glass tube dropped slightly first and then rose again.

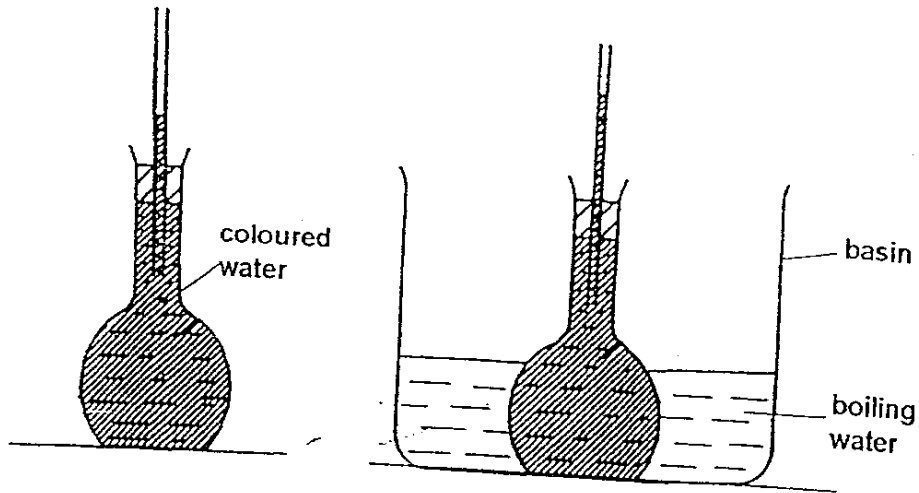

Which one of the following best explains the above observations?

- (1) The flask expanded faster than the water.
- (2) The water expanded first and then contracted.
- (3) The air in the flask was compressed first and then expanded.
- (4) The downward movement of lowering the flask caused the water level to fall and rise.

13. Study the table below.

Property \ Object	A	B	C
Is it flexible?	Yes	No	Yes
Is it a conductor of heat?	Good	Poor	Poor

Which one of the following sets of objects share the same properties as objects A, B and C?

	A	B	C
1)	copper wire	graphite	woollen gloves
2)	diamond ring	silver chain	glass jar
3)	graphite	brass knob	wooden bench
4)	zinc roof	copper kettle	diamond cutter

14. The Venn diagram below shows examples of activities involving forces.

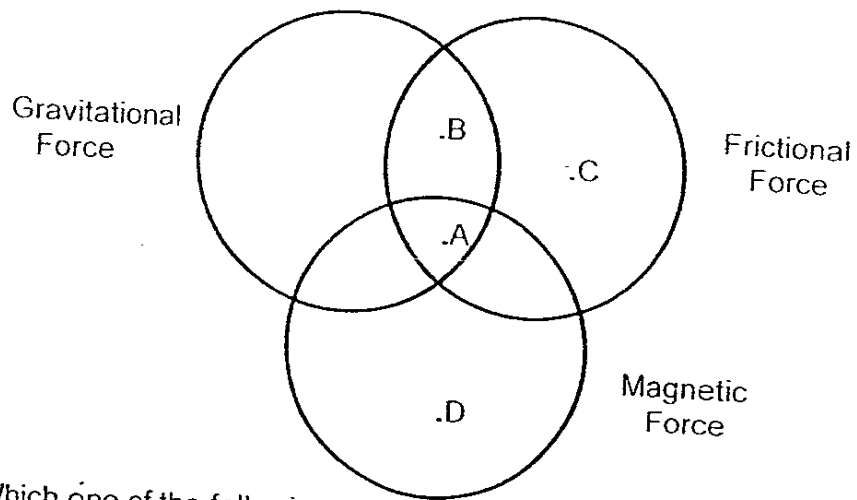

Which one of the following options correctly shows the forces in action?

	A	B	C	D
(1)	Swimming across a fast flowing river	Walking along a winding path	Applying brake to stop a car	Attracting a nail with a magnet held above it
(2)	Dropping a circular magnet onto an iron ramp	Skating up a ramp	Sharpening a knife	Using a compass to look for navigation
(3)	Dropping a piece of magnet onto the floor	Kicking a stone into the drain	Writing with a pencil	Picking up marbles with chopsticks
(4)	Diving into a swimming pool	Stretching a rubber band	Pushing a pile of books across a table	A train running on a track

15. Ali had 3 rods labelled A, B and C. He carried out an activity with each of the three rods using a bar magnet and recorded his results in the table below.

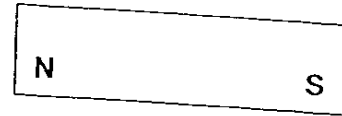
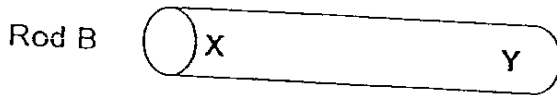
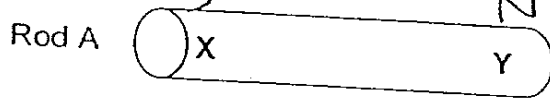

Bar magnet

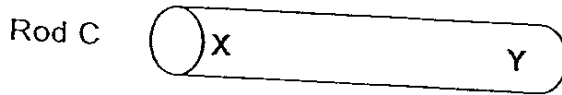

Rod	Result
A	X was attracted to the north pole of the magnet but Y was repelled.
B	Both X and Y were attracted to the south pole of the magnet.
C	Both X and Y had no effect at all when both ends of the magnet were brought near.

Which one of the following statements about Rods A, B and C is true?

- (1) Only Rod A has magnetic properties.
- (2) Both Rods A and B are magnets.
- (3) Rod B is made of a magnetic material but not Rod C.
- (4) Only Rod C can become a temporary magnet when stroked by a magnet.

16. Xiao Fen set up an experiment as shown below. When she placed Sheet A between the magnet and paper clip, she noticed that the paper clip floated in the air.

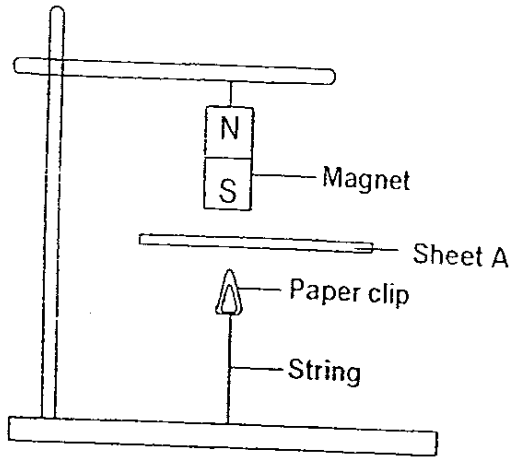

Which of the following materials could sheet A be made of?

- A Aluminium.
- B Glass
- ~~C~~ Nickel

- (1) A and B only
- (2) B and C only
- (3) A and C only
- (4) A, B and C

17. Study the energy conversion diagram below.

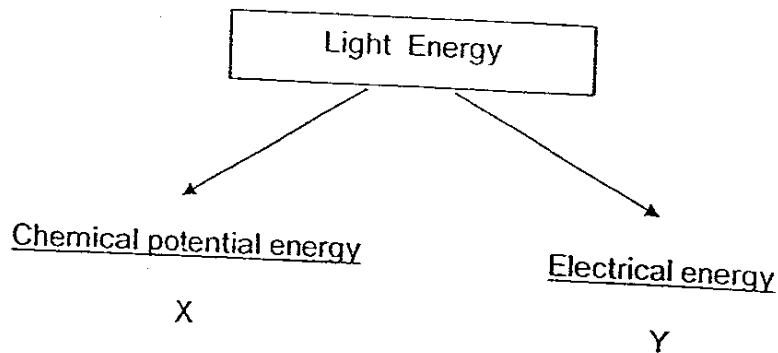

Which of the following examples given below correctly represent X and Y?

	X	Y
(1)	A lighted bulb	Using solar heaters at home
(2)	Exploding fireworks	Radio blasting loud music
(3)	Using a digital camera	Starting a car engine
(4)	Plants photosynthesizing	Operating a solar calculator

18. The diagram below shows the energy conversion from one useful form to another.

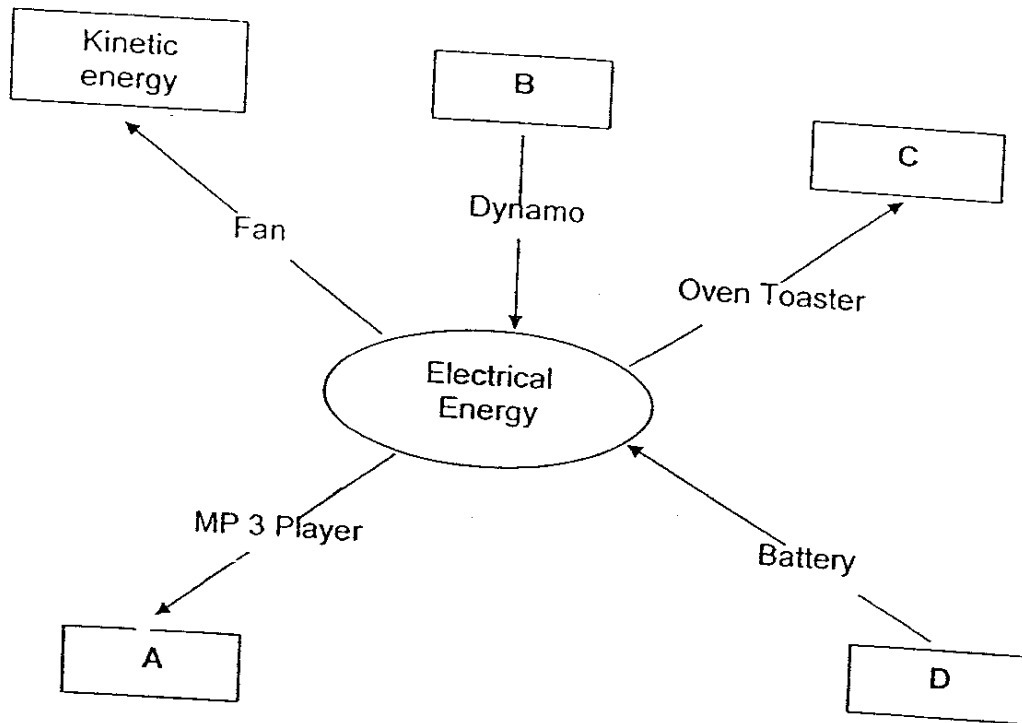

Which one of the following best represents the letters in the boxes?

	A	B	C	D
(1)	Sound energy	Kinetic energy	Light energy	Chemical potential energy
(2)	Kinetic energy	Chemical potential energy	Heat energy	Sound energy
(3)	Sound energy	Kinetic energy	Heat energy	Chemical potential energy
(4)	Light energy	Heat energy	Chemical potential energy	Kinetic energy

41

19. Ali drilled equal-sized holes each in the base of 3 containers, A, B and C and plugged each hole with plasticine. Then, he filled each container with water and hung them on a beam as shown below.

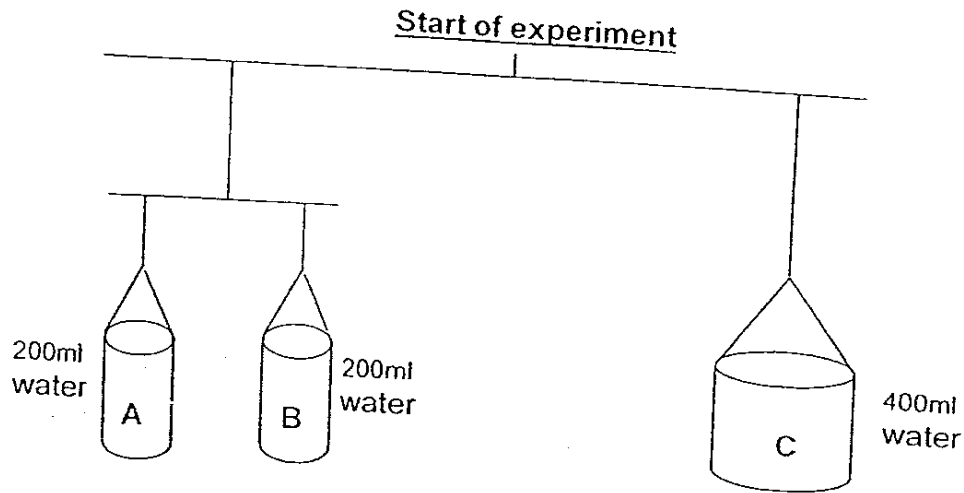

Which of the following would be likely observed when plasticine at the base was removed from all the containers at the same time to the point before all the water was drained off?

- (1) Container C tilted downwards.
 - (2) Both containers A and B tilted downwards.
 - (3) Containers A and B moved up first and then down.
 - (4) The three containers remained in balance.
20. Study the diagram below.

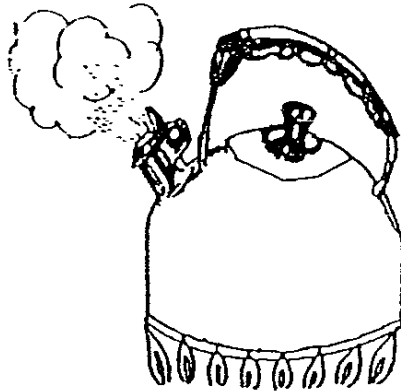

A whistling kettle was left on a lighted stove. What is the energy conversion when the water in the kettle started to boil?

- (1) heat energy \longrightarrow chemical potential energy \longrightarrow light energy
- (2) light energy \longrightarrow kinetic energy + sound energy
- (3) light energy \longrightarrow chemical potential energy \longrightarrow heat energy
- (4) heat energy \longrightarrow kinetic energy + sound energy

21. Study the diagram below.

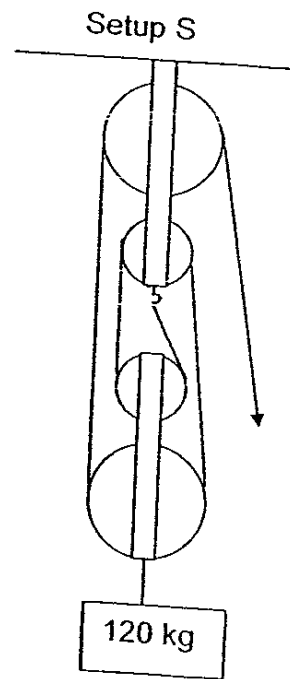
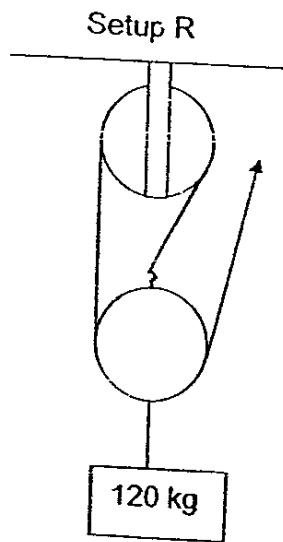
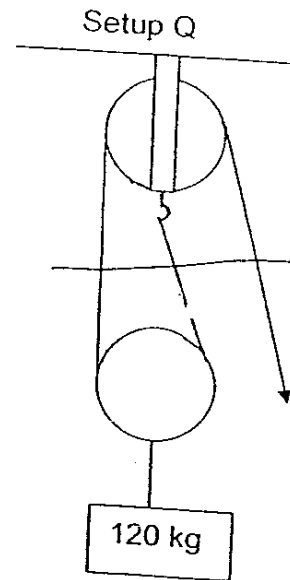
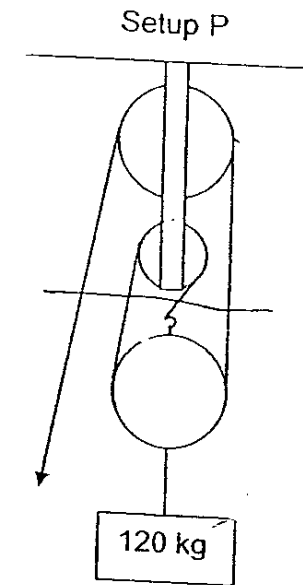

Which of the above setups possess both the following characteristics?

- A The effort used is less than half of the load
- B The effort and load move in the opposite direction.

- (1) R only
- (2) S only
- (3) P and S only
- (4) P, Q and S only

43

22. The diagram below shows a nutcracker.

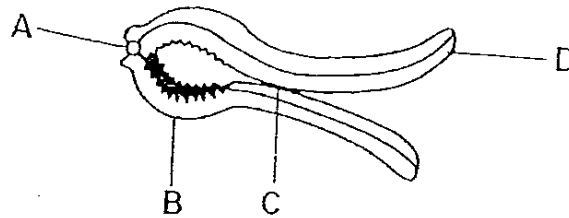

Which one of the following letters A, B, C or D indicates correctly the position of the fulcrum?

- | | |
|-------|-------|
| (1) A | (2) B |
| (3) C | (4) D |

The graph below shows the population of grasshoppers in a corn field. Study it carefully to answer Questions 23 and 24.

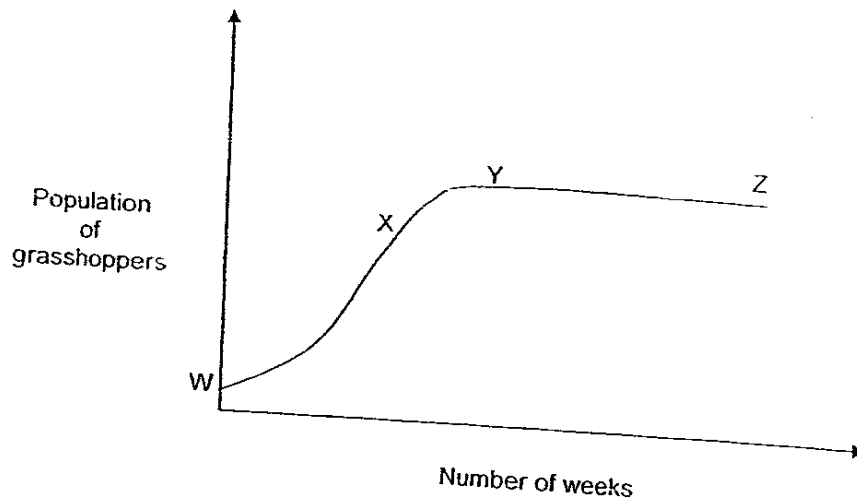

23. What are the likely reasons for the change in the population of grasshoppers from W to Y?

- A a drought
- B a good crop of corn
- C a decrease in the number of birds
- D an increase in the number of praying mantis

- | | |
|------------------|------------------|
| (1) A only | (2) B only |
| (3) B and C only | (4) A and D only |

24. Which one of the following gives the best explanation for the respective parts of the graph?

	W to X	X to Y	Y to Z
(1)	High birth rate Low death rate	High birth rate Moderate death rate	Birth rate equals death rate
(2)	High birth rate Low death rate	Birth rate equals death rate	High birth rate Moderate death rate
(3)	High birth rate Moderate death rate	Birth rate equals death rate	High birth rate Low death rate
(4)	Birth rate equals death rate	High birth rate Low death rate	High birth rate Moderate death rate

25. Study the three food webs, A, B and C shown below.

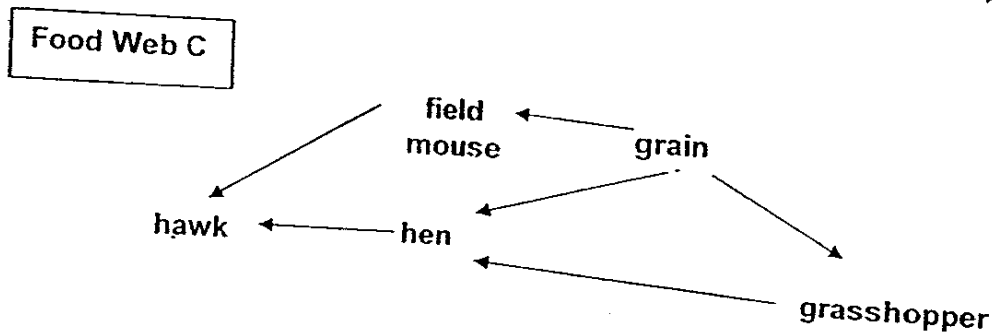
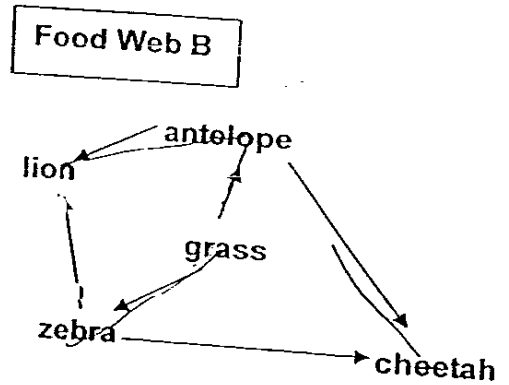
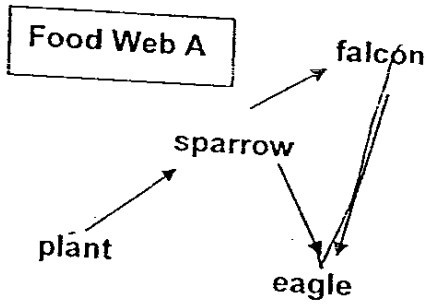

Arrange the food webs according to increasing number of food chains.

- (1) A,B,C
- (2) A,C,B
- (3) B,C,A
- (4) C,A,B

26. Study the following food web given.

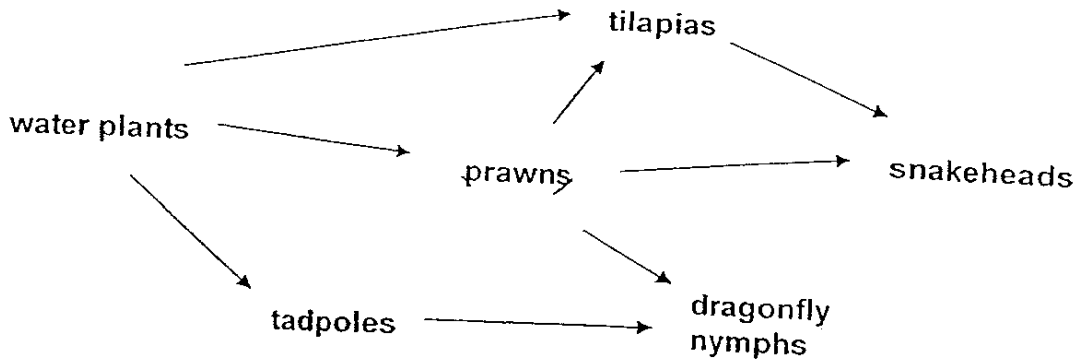

Which of the following statements about the food web is true ?

- A The only herbivores are prawns and tadpoles.
- B Only the snakehead and the dragonfly nymph are predators.
- C Tadpoles are the only food source for the dragonfly nymphs
- D Tilapias, prawns and tadpoles do not compete with each other for food.

27. Look at the drawing of some animals shown below.



Which of the following communities do all these three organisms belong to ?

- A marine community
- B leaf litter community
- C pond community
- D garden community.

- (1) B and D only
- (2) A and D only
- (3) B, C and D only
- (4) A, C and D only

28. The diagram below shows a community.

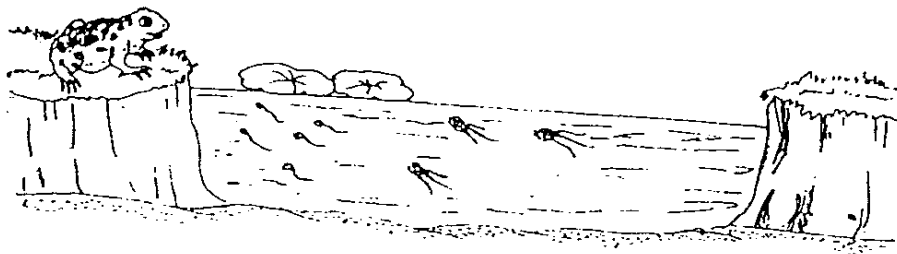

Which of the following conditions stated below affect the living things in the above community?

- A The amount of sunlight available
- B The temperature of the surrounding
- C The amount of dissolved oxygen in the water
- D The presence of other types of living organisms in the water

- (1) A, B and C only
- (2) A, C and D only
- (3) B, C and D only
- (4) A, B, C and D

29. A habitat could support a few communities. Which of the following statement(s) could explain why a garden could support a leaf litter, a rotting log and tree community in it?

- A All organisms living in the garden is a member of one ^{of} the communities.
- B There is competition for food amongst the organisms of the three communities.
- C The physical conditions of the garden are suitable to the organisms of all the three communities for most of the time.

- (1) C only
- (2) A and B only
- (3) B and C only
- (4) A, B and C

30. Which one of the following shows how a marine habitat is similar to a river habitat?

- (1) Both support only a community each.
- (2) There are food producers in both habitats.
- (3) There is no fungi in both habitats to recycle matter.
- (4) All animals in both habitats breathe in dissolved oxygen.

NANYANG PRIMARY SCHOOL

PRIMARY SIX SCIENCE

SEMESTRAL ASSESSMENT 1

2006

BOOKLET B

Date : 8th May 2006

Duration : 1 h 45 min

Name : _____ ()

Class: Primary 6 ()

Marks Scored:

Booklet A:	60
Booklet B :	40
Total :	100

Parent's signature:

DO NOT OPEN THIS BOOKLET UNTIL YOU ARE TOLD TO DO SO.
FOLLOW ALL INSTRUCTIONS CAREFULLY.

Booklet B consists of 17 printed pages including this cover page.

Section B (40 marks)

Write your answers to questions 31 to 46 in the spaces provided.

31. Study the diagram below.

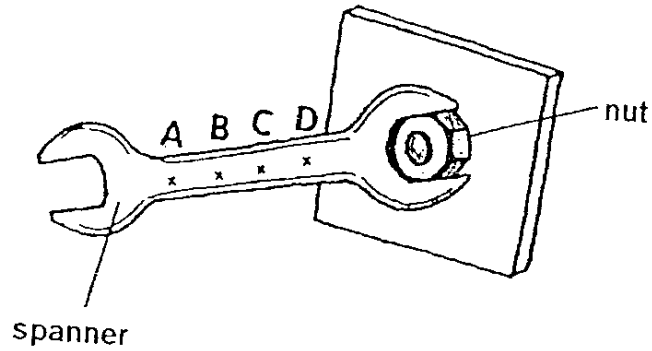

Muthu is going to turn the spanner to loosen the nut.

(a) At which point must he apply his effort in order to loosen the nut most easily? (1 mark)

(b) What type of simple machine does the spanner represent in the above example? (1 mark)

32. The diagram below shows a gear system. Gear A and C has 24 teeth each, whilst gear B has 16 teeth and Gear D has 12 teeth. The arrow shows the direction in which Gear D turns.

(a) Peter wanted to bring the movement of the gear system to a stop by applying a single force. Draw an arrow in one of the boxes provided below to show the direction of this force. (1 mark)

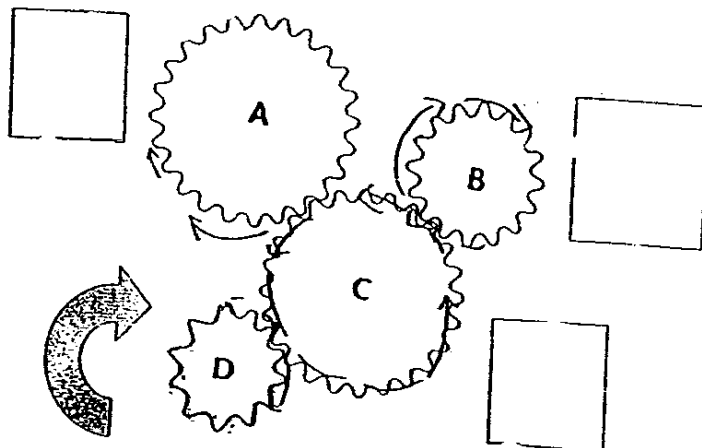

49

- (b) How many rounds would Peter need to move gear D if he wanted gear B to complete 3 rounds?
(1mark)
-

33. Study the diagram below.

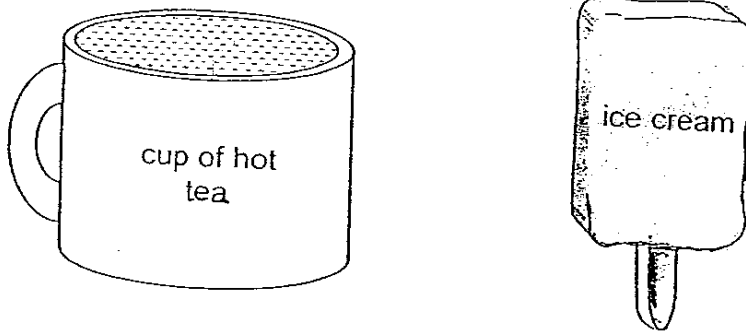

Room temperature at 30 °C

- (a) When placed in the same surrounding after a period of time, the ice cream melted and the cup of hot tea cooled down. What does this observation show?
(1mark)
- (b) If the items had been placed in a room with temperature at 15 °C, what would be observed of the cup of hot tea and ice cream?
AS (1 mark)
compared to that in A.

34. Mei Lin prepared 2 setups shown below to collect pure water. She left them in the garden for the same period of time.

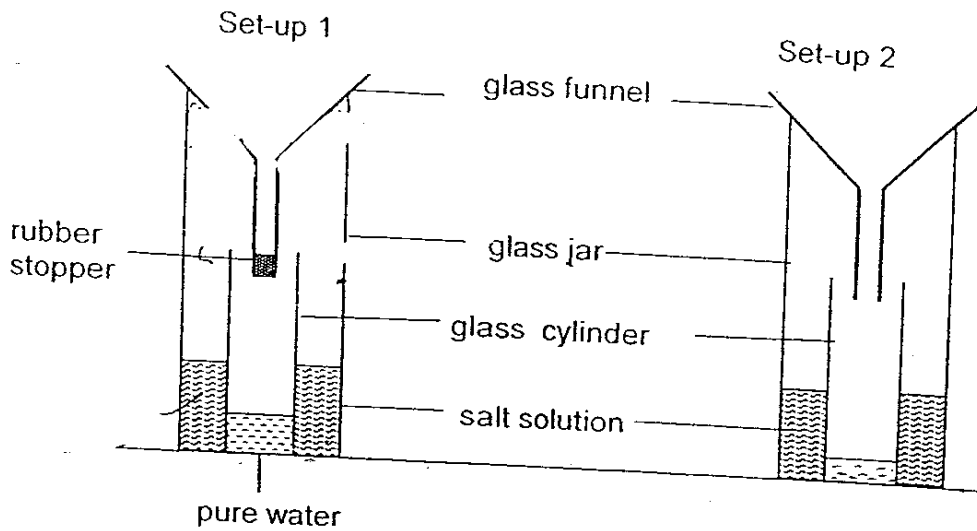

- (a) Name both the source and type of energy for the above set-ups to work. (1 mark)
-
- (b) Draw in diagram above the amount of water collected in set-up 2. (1 mark)
- (c) Explain your answer in (b) (1 mark)

35. Mr. Wong made a plywood toy car as shown below

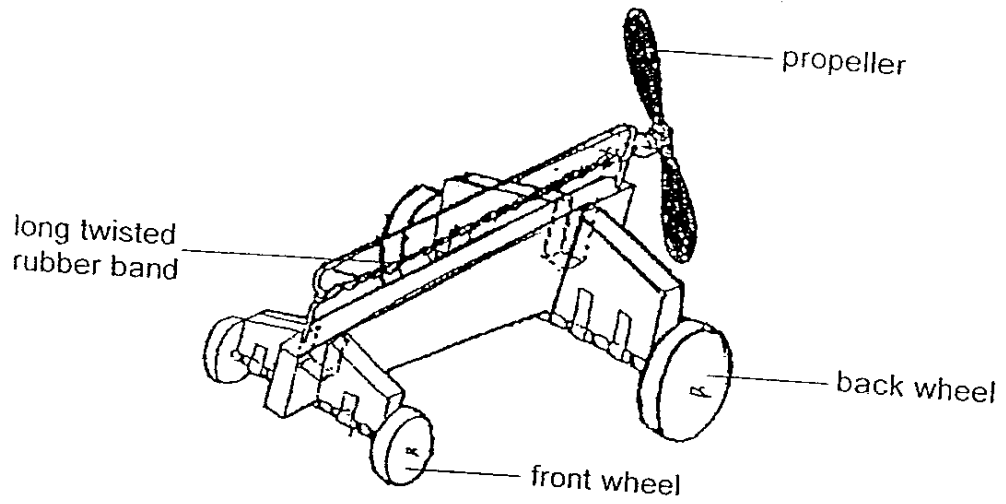

(a) Which part of the toy car possesses the energy needed to allow it to move?
(1 mark)

(b) Without changing the set-up of the car, what must he do if he wants to increase the speed of his toy car?
(1 mark)

36
PSLE
Favorite

Sharif used the set-up below to conduct an experiment below. He used different magnetic materials of the same size and shape. He kept adding weights until the magnetic material was no longer attracted to the magnet.

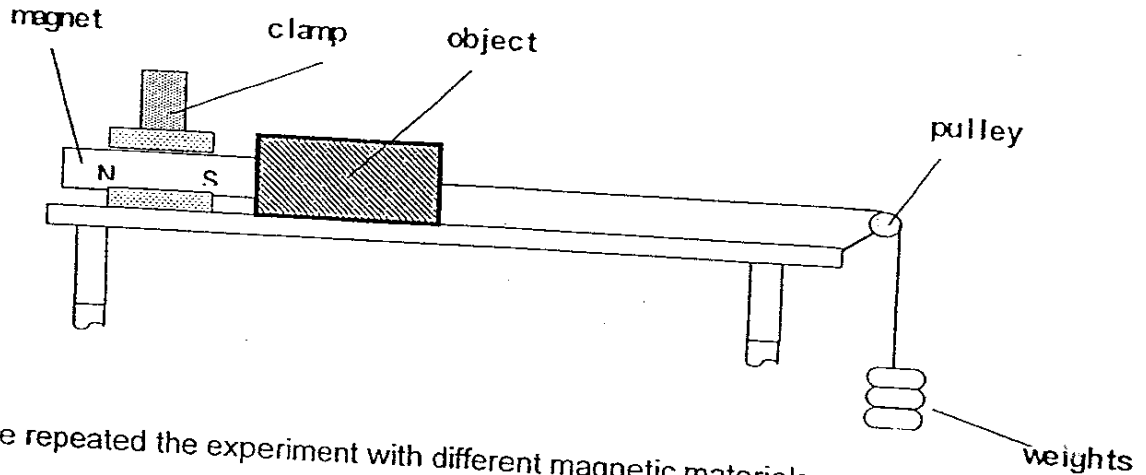

He repeated the experiment with different magnetic materials.

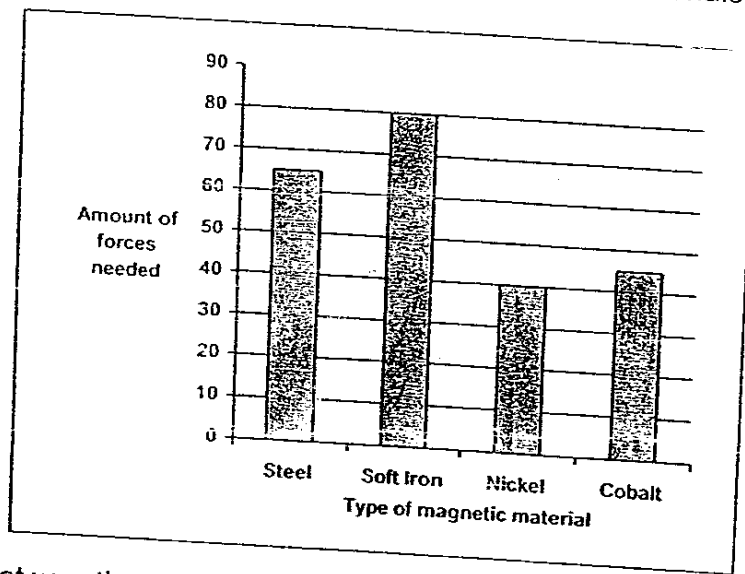

- (a) What was the aim of the experiment above? (1 mark)
-
- (b) Give another variable that must be kept constant for the magnetic materials in this experiment. (1 mark)
-

37. A ball was dropped from a table as shown in the diagram below.

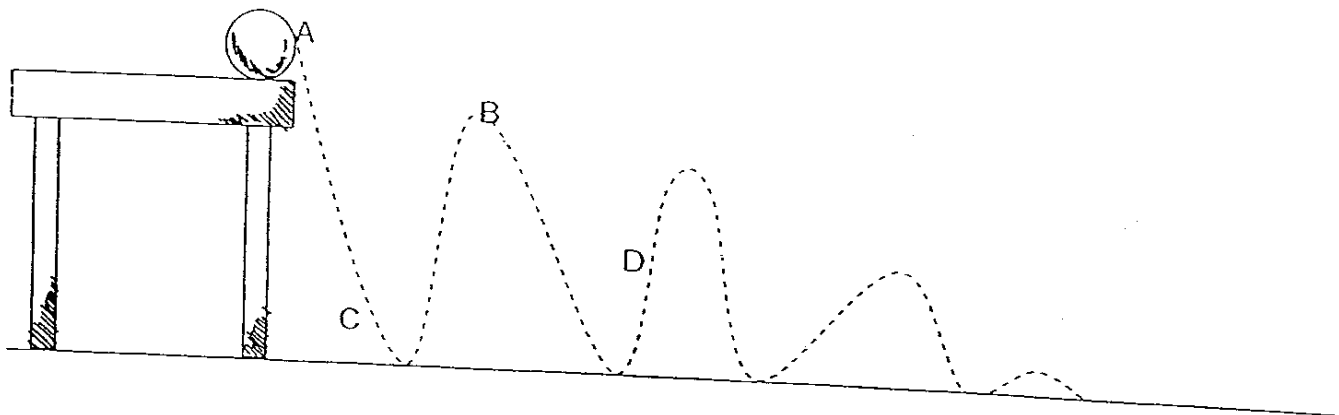

- (a) At which point, A, B, C or D, did the ball move with the fastest speed?

(1 mark)

- (b) Explain your answer in (a).

(1 mark)

- (c) Why did the height of the ball decrease with each bounce? (2 marks)

38. The diagram below shows 4 bells, A, B, C and ~~D~~^{and} in a circuit.

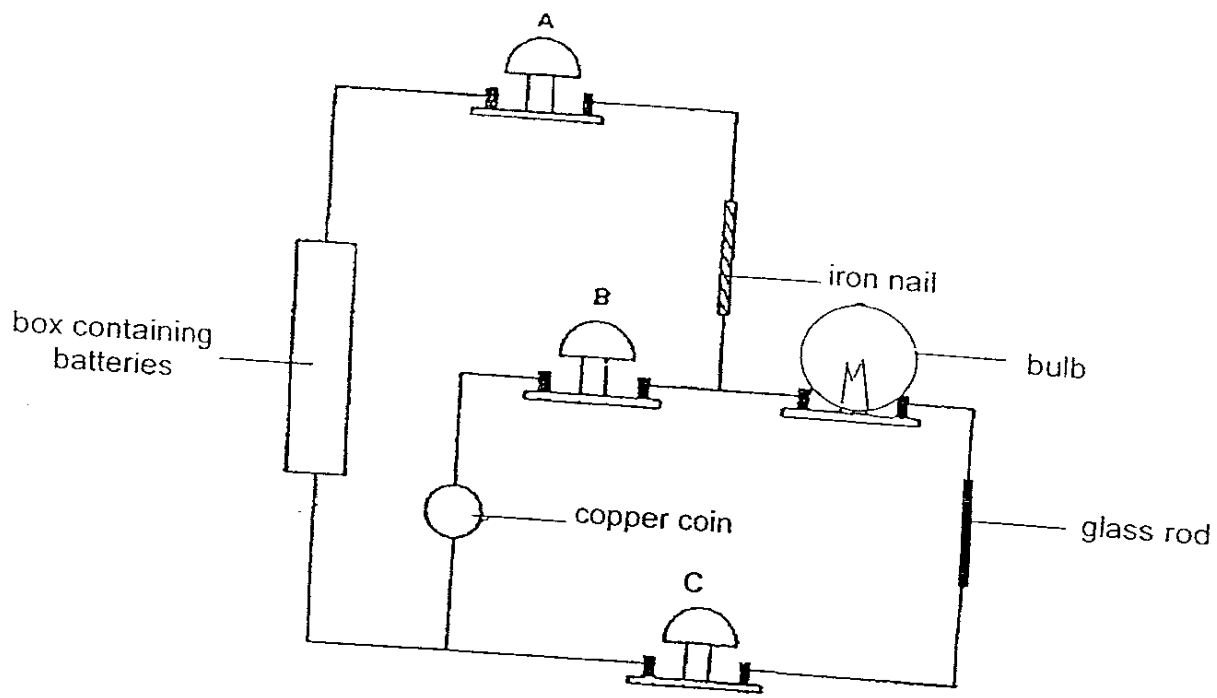

- (a) State the conversion of energy when the circuit is closed. (1 mark)
-
- (b) Which of these bells A, B or C will ring? (1 mark)
-
- (c) Give a reason for your answer. (1 mark)

39 (a). The diagram below shows a brass rod and a wooden rod held together tightly. A piece of white paper was wrapped tightly around both the rods in the centre.

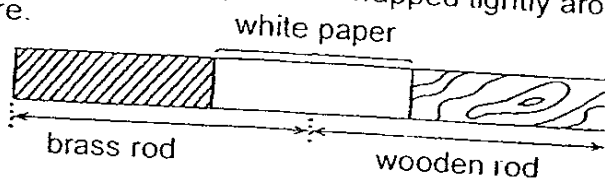

A bunsen flame was then passed over the paper several times.

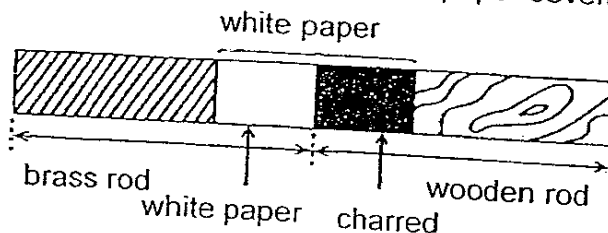

After a while, it was observed that the paper over the wooden rod scorched, while the paper over the brass rod was not. Explain these observations.

(1 mark)

(b) The diagram below shows a cotton skirt which was turned inside out and a hot iron placed on it. The iron was not in direct contact with the buttons as the skirt was turned inside out. After a while, it was observed that some of the cloth around the buttons was scorched whilst others were not.

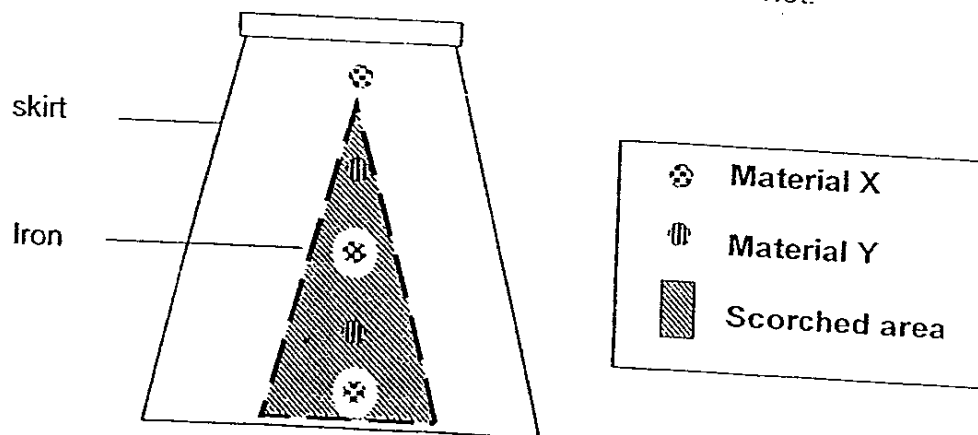

Based on the experiment in (a), what are the likely materials X and Y that the buttons are made of?

(1 mark)

Material X: _____

Material Y: _____

40. The diagrams below show two appliances:

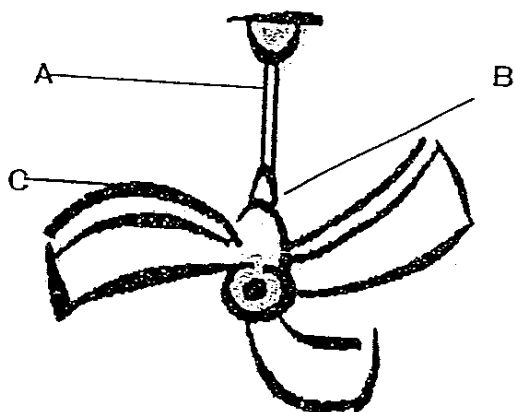

ceiling fan

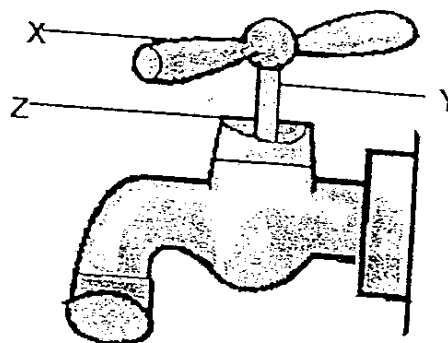

tap

(a) Name the type of simple machine common to both appliances shown above. (1 mark)

(b) Identify using the alphabets listed in the diagram where the effort is applied in each of the appliances shown above. (1 mark)

> ceiling fan : _____

> tap : _____

(c) How does the application of the effort in the ceiling fan help to make work easier? (1 mark)

41. Zaki conducted an investigation to study the behaviour of a desert squirrel for two weeks. This squirrel lives in a burrow and comes out of it several times throughout the day to look for food that is constantly available. He recorded his observations in the table below.

	Time of the day	
	Day	Night
Average no. of appearances in a 24h period	2	8

Zaki also made an interesting observation. He noticed that the squirrel flipped its tail upwards to cover the top of its head and body when it appears in the day. Its tail remains behind its hind legs when it appears at night.



In the day



At night

How does the observation in the diagram above help to explain the data that he has collected?
(2 marks)

42. Tom wanted to find out the living conditions that snails prefer. He used a deep plastic tray and covered half of it with black paper. He also made one side warm and the other side cold. Finally he placed 9 snails in the centre of the tray and observed where the snails were found after half an hour.

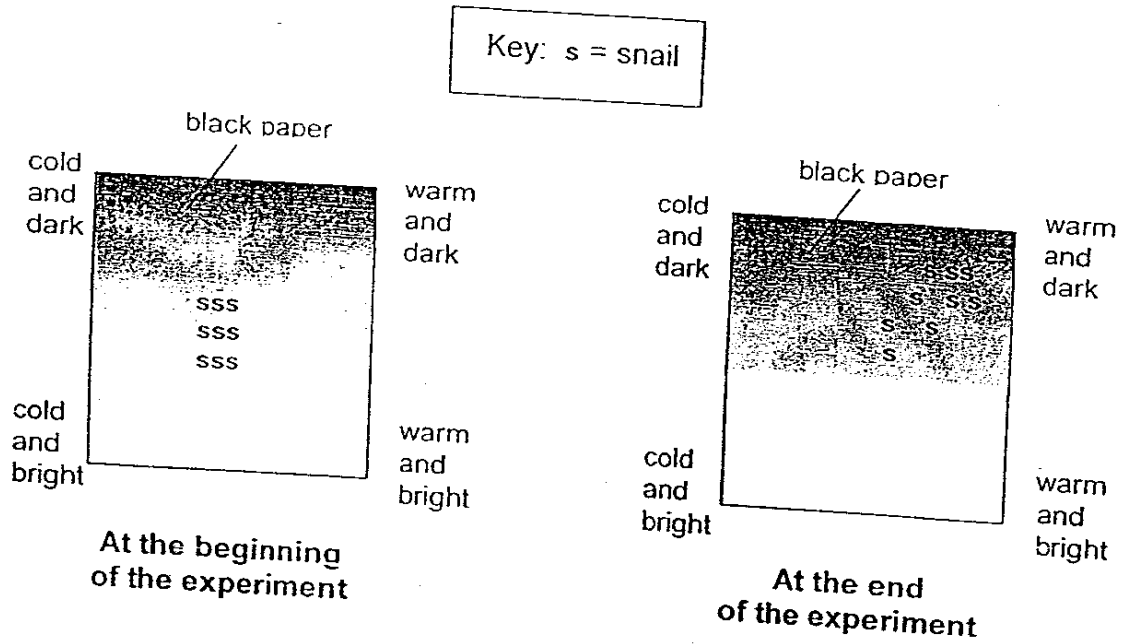

(a) Based on the results, what kind of living conditions do the snails prefer? (1mark)

(b) What should Tom do to ensure that his results are reliable? (1mark)

(c) Why did Tom place the snails in the centre of the tray at the beginning of the experiment? (1mark)

43. A compost heap contains grass clippings, dead garden waste and even shredded newspapers. After 3 months, you will be able to get rich garden compost that can be used as fertilisers for plants.

The following pictures show the steps needed to prepare a compost heap.

Step 1

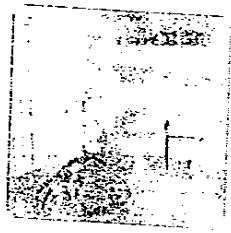

Step 2

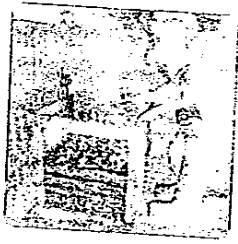

Step 3



- Spread a layer of dry twiggly material either in a 1m² space or on the ground

- Build up the heap in 15cm layers, varying the type of material.
- Sprinkling each layer with manure will speed up the composting process.

- Cover the top of the heap with a piece of black plastic
- Puncture it a few times.
- Weight the cover down with large stones or old bricks.
- Leave for three months.

- (a) In Step 2, manure is added to speed up the composting process. What is present in manure that helps the composting process? (1 mark)

- (b) How does covering the top of the heap with a piece of black plastic help the composting process? (1 mark)

44. A group of pupils counted the organisms found on a rotting log and recorded the results as shown below.

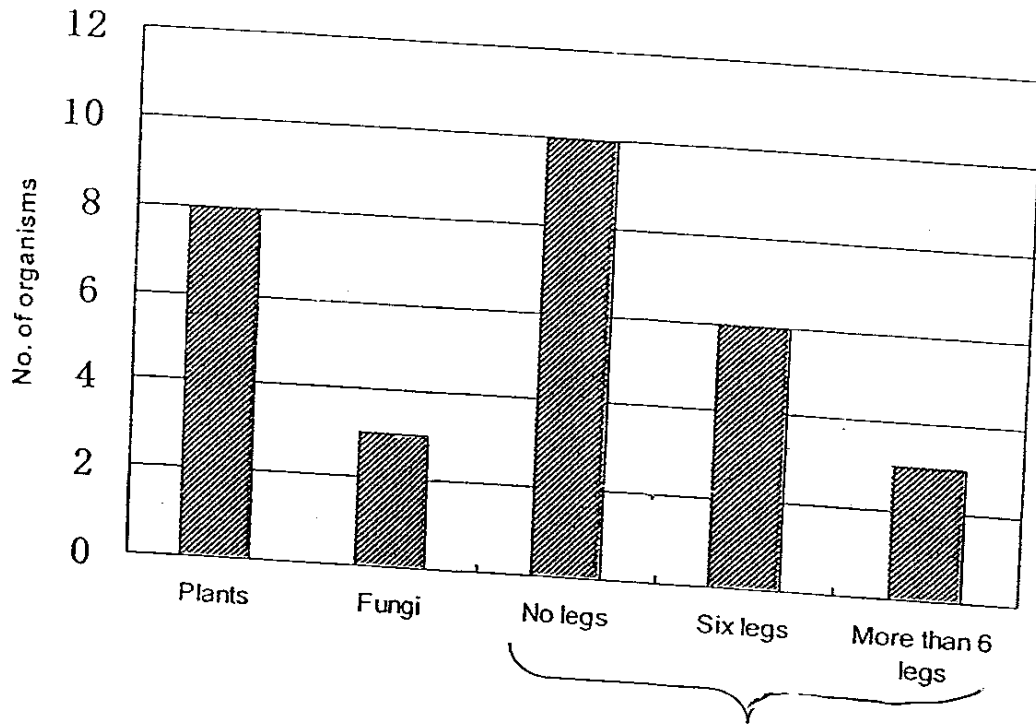

Based on the data above, put a tick in the correct column to indicate if each of the following statements is 'True', 'False' or 'Not Possible to Tell'. (2 marks)

	Statements	Animals		
		True	False	Not possible to tell
i.	All the 6-legged animals belong to one population.			
ii.	There are at least 4 populations of food consumers.			
iii.	When all the plants are removed from the rotting log, all the animal populations would decrease.			
iv.	Plants and fungi are the 2 groups of producers in this community.			

45. In a forest, organisms A were observed living and breeding at three trees, X, Y and Z. These organisms were counted in order to allow scientists to study them. After several years, tree Z was removed. The number of these organisms was again counted at both trees X and Y.

No. of organisms in population A	Tree		
	X	Y	Z
Just before the removal of tree Z	38	35	42
Several hours after the removal of tree Z	49	54	

List 2 possible reasons to explain the change in the size of population A observed at trees X and Y following the removal of tree Z. (2 marks)

Reason 1:

Reason 2:

46. The graphs below show the digestion of three food types, A, B and C, in different parts of the digestive system.

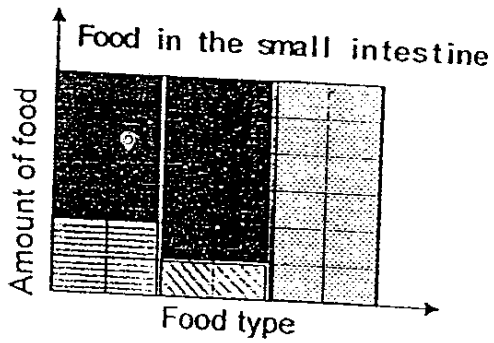
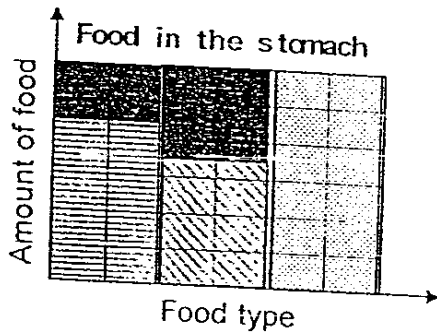
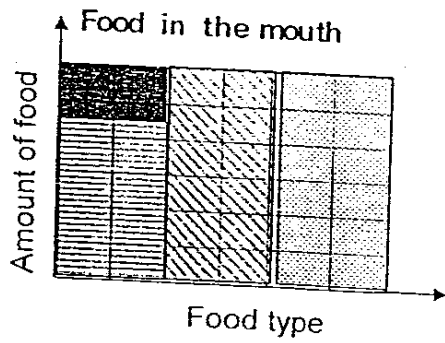
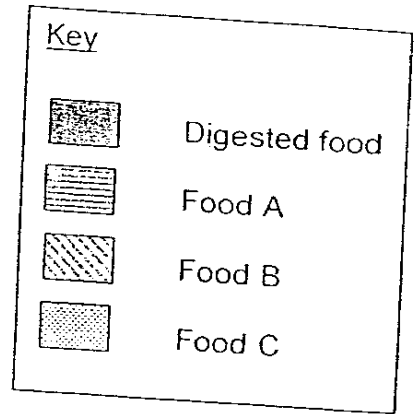
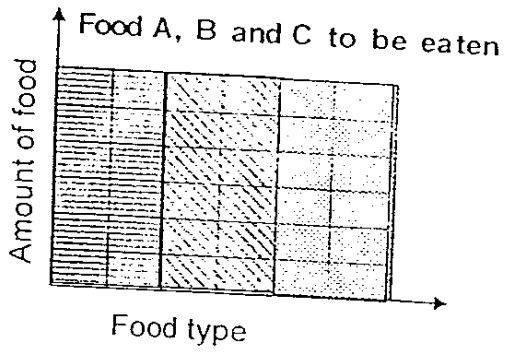

(a) In which organ/s was digestion of Food A carried out? (1 mark)

(b) Using the key given in the graphs above, draw in the graph below to show the amount of digested and undigested Food A, B and C found in the large intestine. (2 marks)

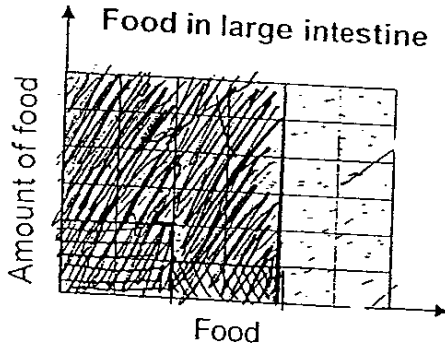

(c)

lettuce	sweets	milk
---------	--------	------

Which of the foods in the above table could Food C most likely to be? (1 mark)

-----END OF PAPER-----

Setters:
Primary 6 Science teachers

Nanyang Primary School
Primary 6 Science SA1 Exams (2006)

(ANSWER KEY)

SECTION A : (60 MARKS)

Qn no.	Ans
1	4
2	4
3	3
4	4
5	2
6	3
7	2
8	3
9	1
10	2

Qn no.	Ans
11	4
12	1
13	1
14	2
15	3
16	1
17	4
18	3
19	1
20	4

Qn no.	Ans
21	3
22	1
23	3
24	1
25	2
26	1
27	1
28	4
29	1
30	2

SECTION B (40 MARKS)

Qn No.	Answers
31a	At point A
31b	Wheel and axle

32a	
32b	4 rounds

Qn No.	Answers
33a	Heat is transferred from a region of high temperature to one of low temperature.
33b	The hot tea cools down faster and the ice-cream melts at a lower rate.

34a	The source is the sun and the type of energy is heat energy.
34b	B
34c	<p>Heat from the sun heats up the salt solution and makes it evaporate. When the water vapour touches the cool surfaces of the gas cylinder, it condenses and the pure water will fall into the pure water container. However, as there is an opening in setup 2, the water vapour can escape from the hole.</p>

35a	The long twisted rubber bd. n
35b	Twist or spin the propeller more times so that the rubber band is twisted more.

36a	To find out which object had the strongest attraction to the magnet.
36b	The mass of the weight must be the same.

37a	C
37b	At A, the ball possesses the most gravitational potential energy, so when it is dropped more kinetic energy is converted from gravitational potential energy, thus this ball moved with the fastest speed.
37c	Some of its kinetic energy is converted into sound energy and heat energy due to friction between the ball and the surface of the floor.

Qn No.	Answers
38a	Chemical potential energy → electrical energy → sound energy
38b	A and B will ring.
38c	The glass rod is an insulator of electricity, so it causes the circuit to be open therefore bell C cannot ring, however the copper coin and the circuit to be closed, letting bell A and B ring.

39a	When the burden flame passes over the paper, the paper gains heat. The paper, causing half of it not to be scorched, however the wooden rod is a poor conductor of heat, so it cannot conduct heat away from the paper, causing the other half of the paper to be scorched.
39b	Material X : Steel Material Y : Plastic

40a	Wheel and axle
40b	Ceiling Fan : A Tap : X
40c	The rod of the ceiling fan where the effort is applied at only needs to move a shorter distance than the blades of the fan for them to spin.

41	In the day, the temperature is high so the squirrel does not appear so frequently. If it does, it raises its tail to provide shade in the hot sun. In the night, the temperature is lower; the squirrel is more active and appears more frequently.
----	---

42a	The snails prefer a warm and dark place.
42b	He should do the experiment 3 times to check if the snails really preferred living conditions are the same.
42c.	To make sure that the snails have equal distance to move to the area that they have chosen.

43a	Decomposers are present manure and decomposers can help break down the waste into simple substances.
43b	The black plastic absorbs a lot of heat, which moisture in the manure and waste and the decomposers can break them down quickly.

44 (i)	Not possible to tell
(ii)	True
(iii)	True
(iv)	False

Qn No.	Answers
45	Unfavourable environments
	Adapt to a new conditions.

46a	The mouth
46b	<p style="text-align: center;">Food in the Small intestine</p> <p style="text-align: center;">Food type</p>
46c	Milk