

Index Number

					-	
--	--	--	--	--	---	--

NAN HUA PRIMARY SCHOOL
PRIMARY SIX PRELIMINARY EXAMINATION 2006

SCIENCE
BOOKLET A

Name: _____

Class: Primary 6 _____

Date: _____

Parent's signature

BOOKLET	POSSIBLE MARKS	ACTUAL MARKS
A	60	
B	40	
TOTAL	100	

Total time for booklets A and B: 1 h 45 min.

DO NOT OPEN THIS BOOKLET UNTIL YOU ARE TOLD TO DO SO.

**THERE ARE 30 QUESTIONS IN THIS BOOKLET. FOUR OPTIONS ARE GIVEN.
ONE OF THEM IS THE CORRECT ANSWER. MAKE YOUR CHOICE (1, 2, 3 OR 4)
BUBBLE IN THE CORRECT OVAL ON THE OAS (OPTICAL ANSWER SHEET)**

1. Study the table below carefully.

Characteristics	Animal X	Animal Y
i) Three stages in life cycle	Yes	No
ii) The young resembles the adult	Yes	No
iii) It is a pest in one or more of its stages	Yes	Yes
iv) The mother looks after her young	No	No

Which two animals would fit the descriptions in the table above?

	Animal X	Animal Y
(1)	Housefly	Grasshopper
(2)	Cockroach	Butterfly
(3)	Frog	Grasshopper
(4)	Hen	Mealworm Larva

2. Which of the statements below **correctly** describes the difference/s between the plant cell and the animal cell?

A	The cytoplasm in a plant cell appears as a thin lining whereas in an animal cell cytoplasm is seen to fill the cell.
B	The shape of a plant cell changes whereas the shape of an animal cell does not.
C	A plant cell has chloroplasts whereas an animal cell does not.

- (1) A and B only
 (2) A and C only
 (3) B and C only
 (4) All the above

3. The diagram on the right shows a tree.

Which of the following statements about the parts of the tree is **incorrect**?

- A. The branches spread the leaves out so as to maintain its balance.
- B. The leaves spread out to receive air, rain and sunlight.
- C. The roots spread out to reach for water and minerals.
- D. The roots help the tree remain upright.

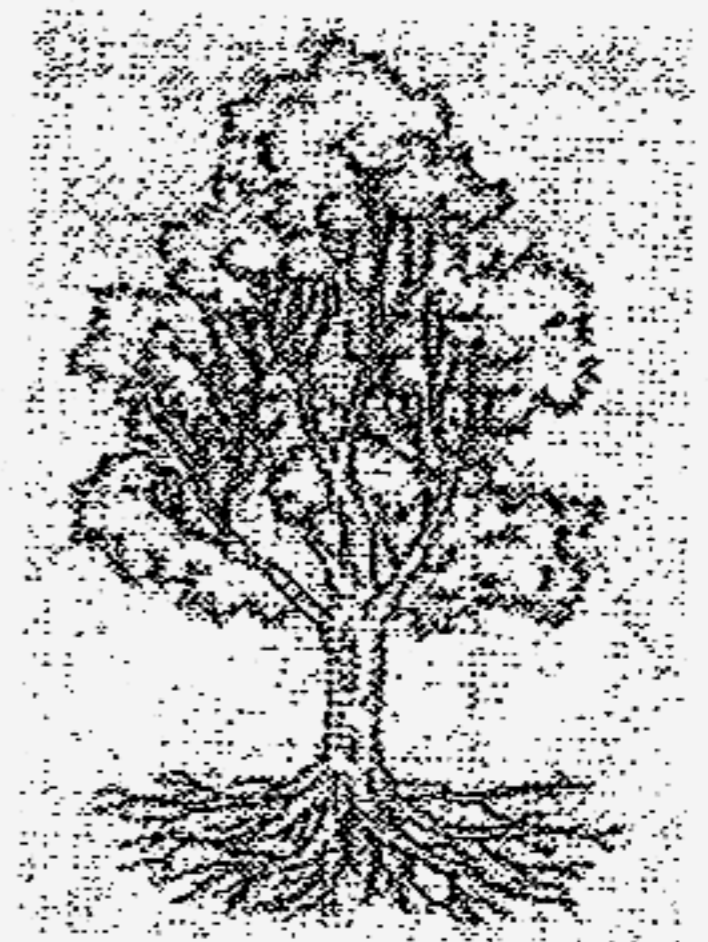

- (1) A and B only
- (2) B and C only
- (3) A, B and D only
- (4) B, C and D only

4. Terrance kept some grasshoppers in a little cage in a corner of his garden. He recorded the grasshopper population over a period of time in a graph. One day, he decided to add 2 toads into the cage.

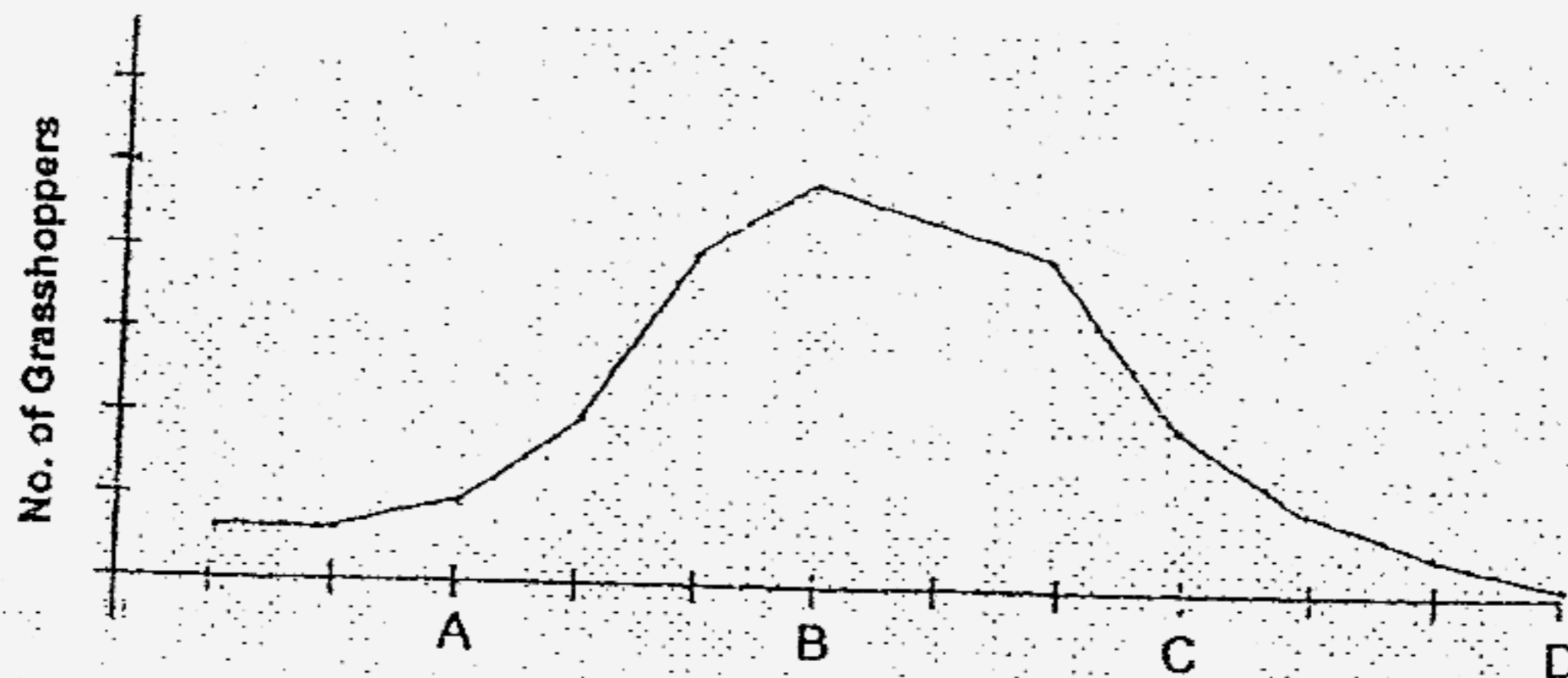

From the graph above, at which point of time were the toads introduced?

- (1) A
- (2) B
- (3) C
- (4) D

5. The following sentences describe how sexual reproduction in plants takes place. Arrange them in order.

- A Male cell fuses with female cell
- B Pollen grains are transferred to stigma
- C Anther releases pollen grains
- D Seed develops
- E Pollen tube grows towards ovule

- (1) C ⇒ B ⇒ E ⇒ A ⇒ D (2) B ⇒ C ⇒ E ⇒ A ⇒ D
 (3) C ⇒ B ⇒ D ⇒ A ⇒ E (4) B ⇒ C ⇒ A ⇒ E ⇒ D

6. Study the diagram below carefully.

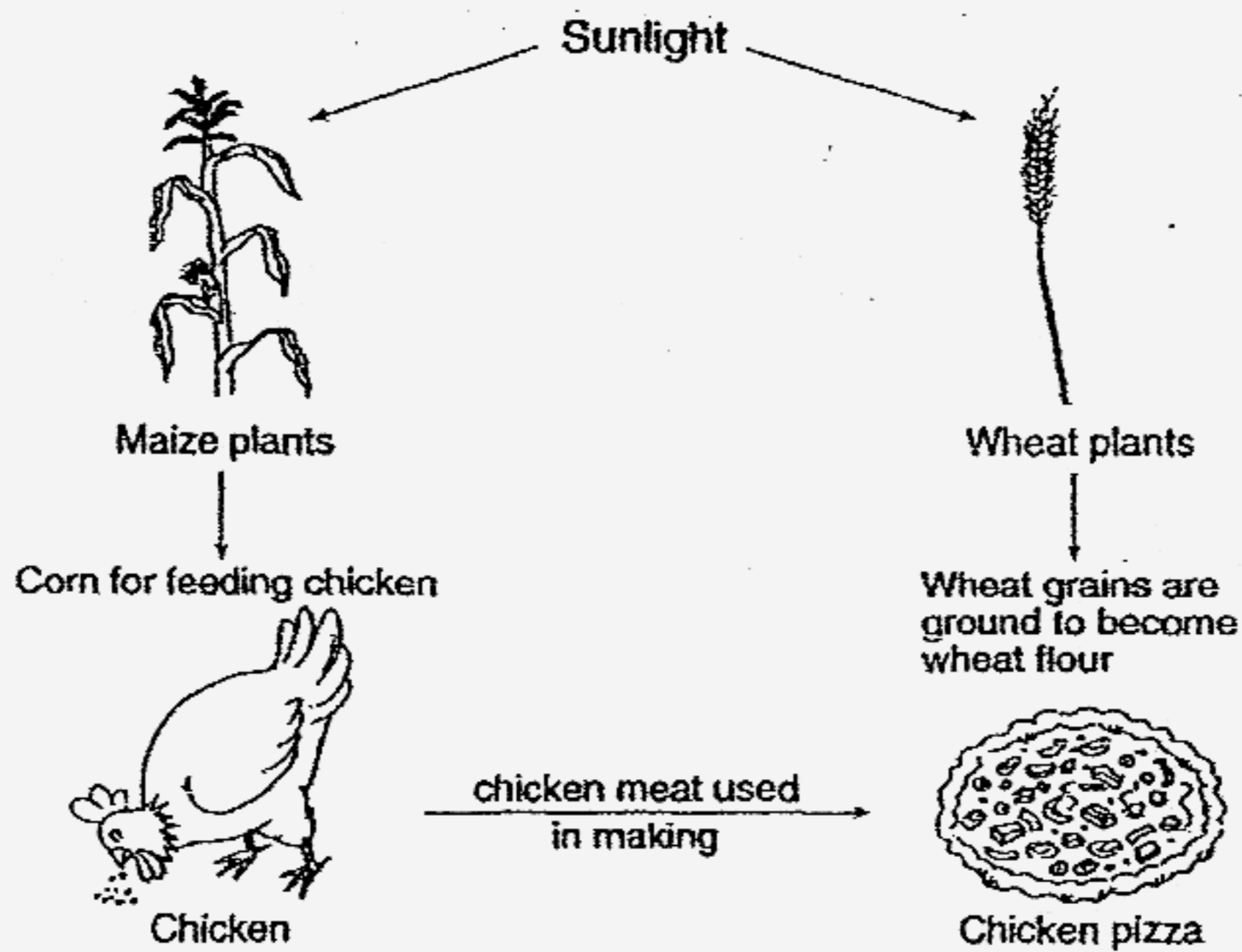

Which of the statements below about the diagram above is **correct**?

- A The chicken is a primary consumer.
- B The diagram shows a food web.
- C The sun is the main source of energy.
- D The arrows show a flow of energy transfer.

- (1) A, B and C (2) A, B and D
 (3) A, C and D (4) B, C and D

7. Which organisms are **correctly** classified based on their mode of reproduction?

	Sexual Reproduction		Asexual Reproduction	
	Seeds	Spores	Budding	Binary Fission
(1)	Hibiscus	Staghorn Fern	Paramecium	Bacteria
(2)	Papaya	Toadstool	Bryophyllum	Hydra
(3)	Staghorn Fern	Bread Mould	Hydra	Paramecium
(4)	Tomato	Bird's Nest Fern	Yeast	Amoeba

8. Study Edward's family tree below carefully.

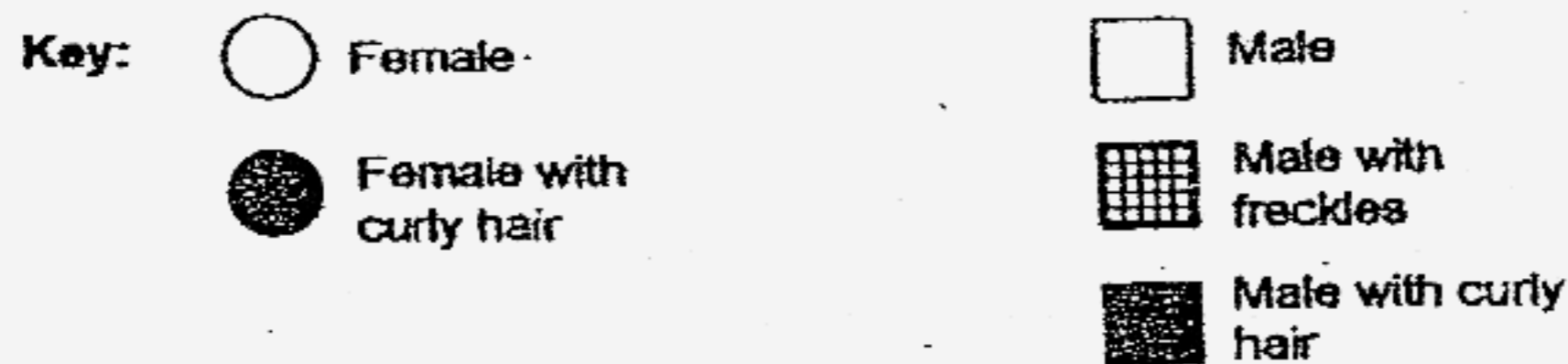
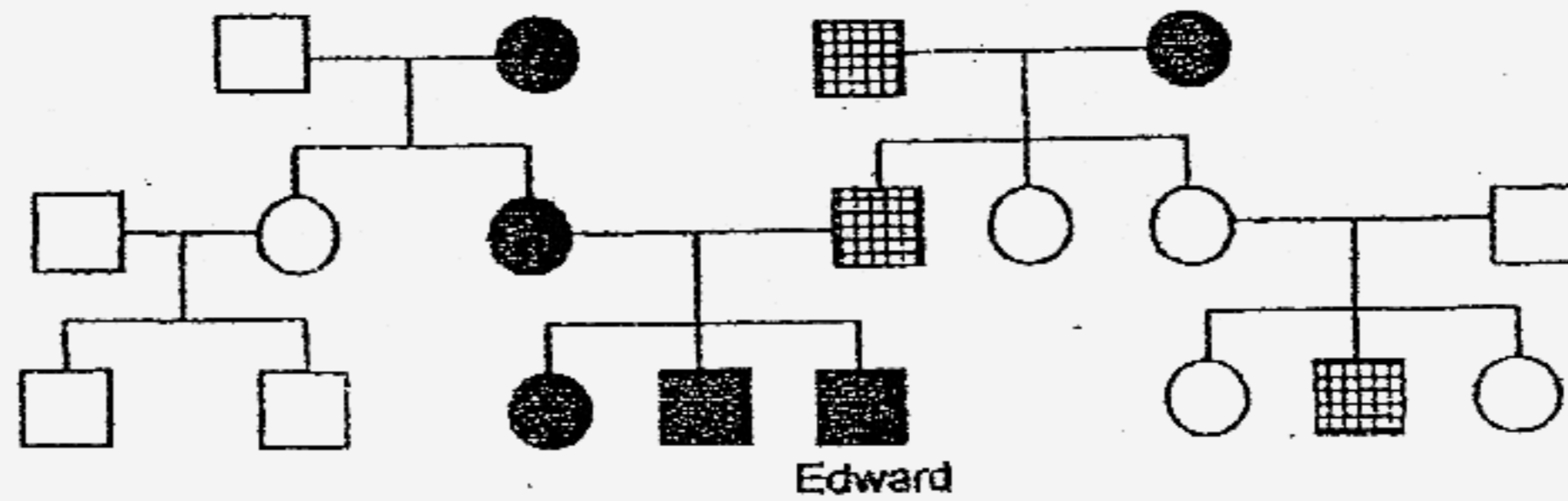

Which one of the following statements is **true**?

- (1) Edward has three uncles altogether.
- (2) Edward's maternal grandmother has curly hair.
- (3) Edward's mother and his aunt are identical twins.
- (4) Edward's male cousin's freckles came from his grandmother.

9. Study the classification table below.

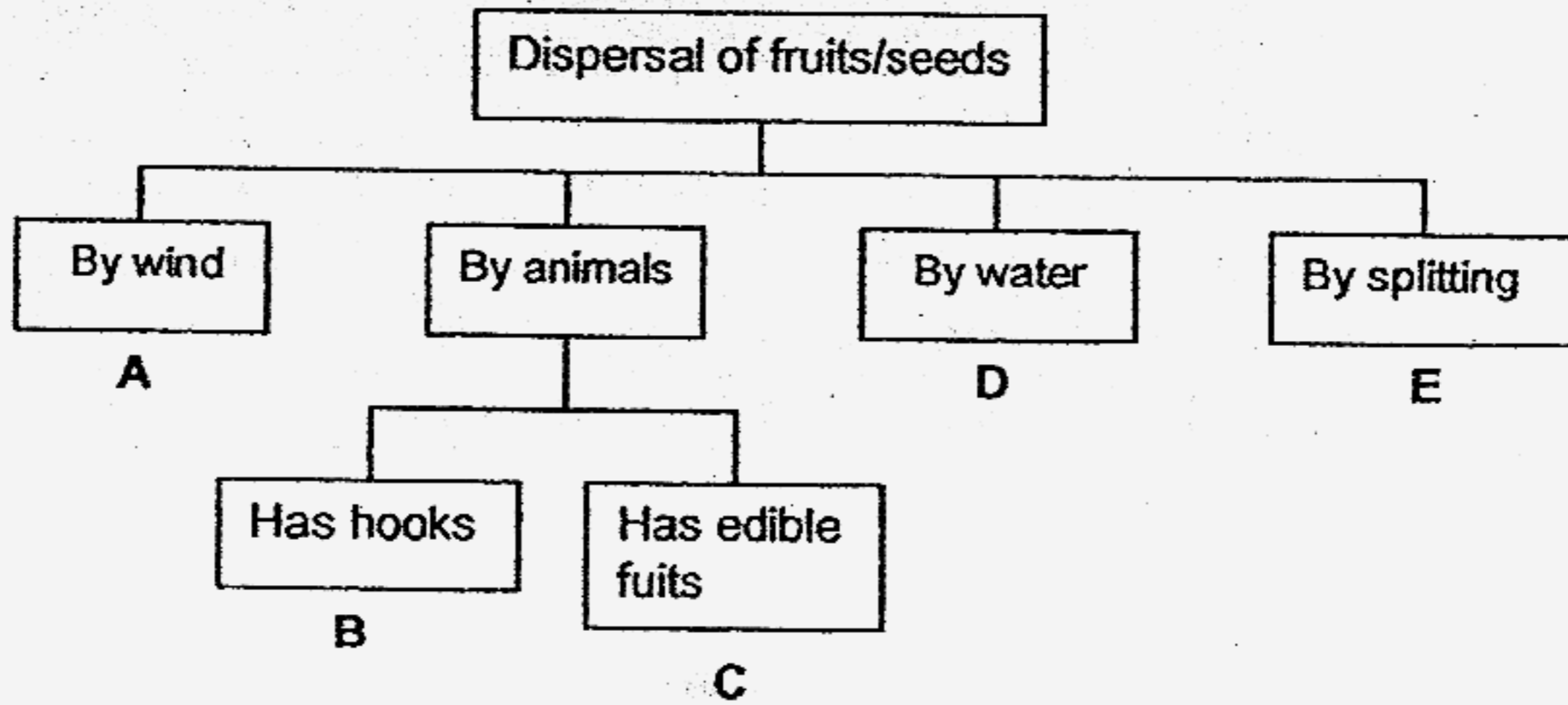

Which one of the examples of plants given is correct?

	A	B	C	D	E
(1)	Mimosa	Love Grass	Rambutan	Coconut	Balsam
(2)	Vernonia	Love Grass	Papaya	Pong Pong	Rubber
(3)	Lallang	Mimosa	Coconut	Nipah	Lady's Finger
(4)	Lallang	Rambutan	Guava	Lotus	Rubber

10.



The simple diagram below shows the flow of blood in our body. Which arrows show blood that is rich in oxygen?

- (1) A and B only (2) A and C only
 (3) B and D only (4) C and D only

11. Which of the following statements about blood vessels is true?
- A, There are three types of blood vessels in our body.
 - B, Arteries have very strong walls because they carry blood under high pressure.
 - C, Veins have very strong walls because they carry blood under high pressure.
 - D, Capillaries are very narrow blood vessels that join arteries to the veins.
- (1) A and C only
 (2) A and D only
 (3) A, B and D only
 (4) A, C and D only

12. Goh Leng set up four beakers M, N, P and Q as shown below. He placed three green beans in each of the beakers. Beakers M, N and Q were kept at room temperature while beaker P was kept in the refrigerator.

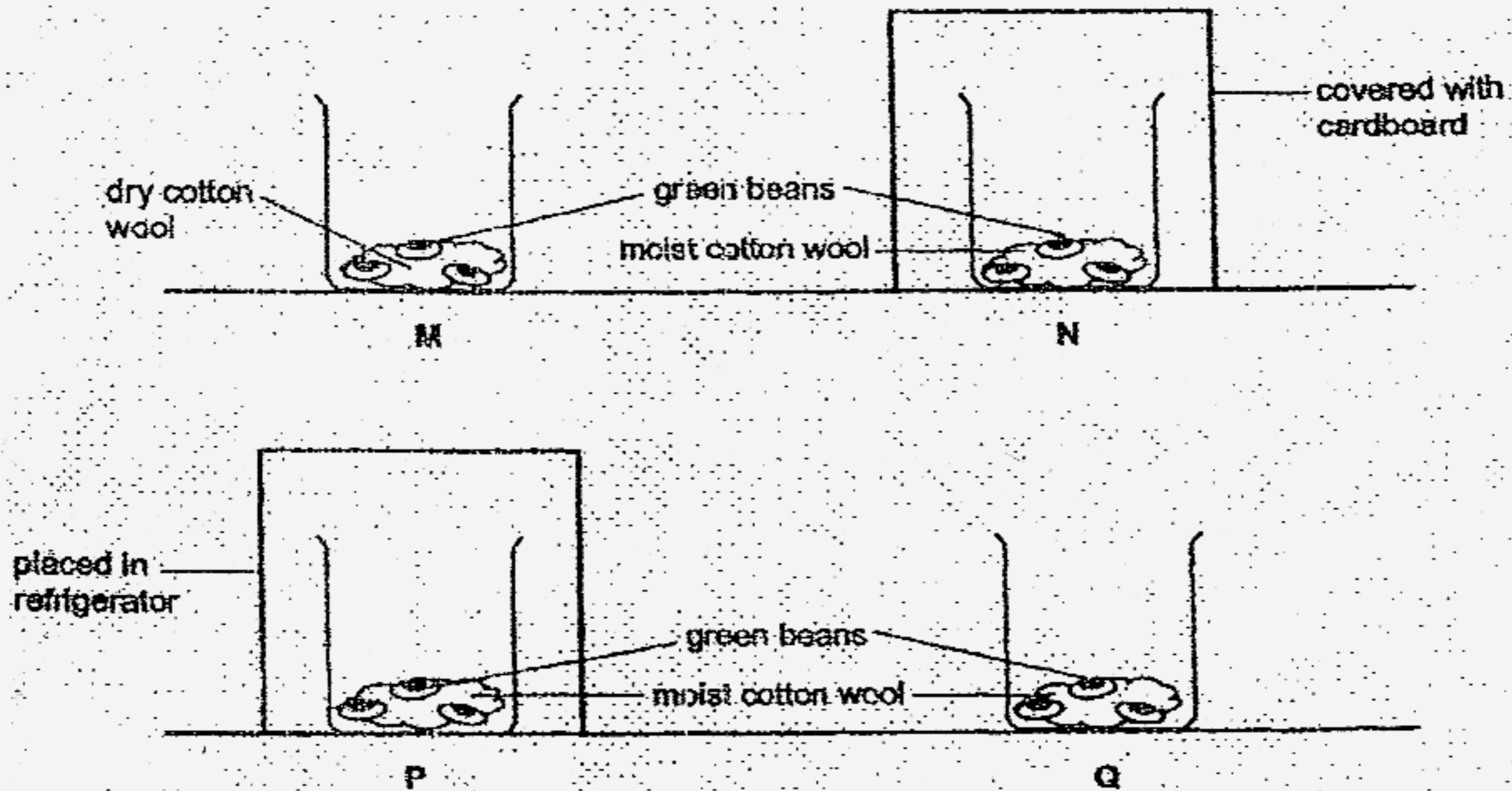

He observed that the green beans in Beakers N and Q grew into young seedlings while those in Beakers M and P did not.

Which of the following conclusions can Goh Leng draw based on his observation?

- A, Warmth is needed for the seeds to germinate.
 - B, Light is necessary for the seeds to germinate.
 - C, Water is needed for the seeds to grow into seedlings.
- (1) A and B only (2) A and C only
 (3) B and C only (4) A, B and C

13. The graph below shows how the amount of insecticide used can affect the number of fruits harvested. Based on the graph, which of the following statements are true?

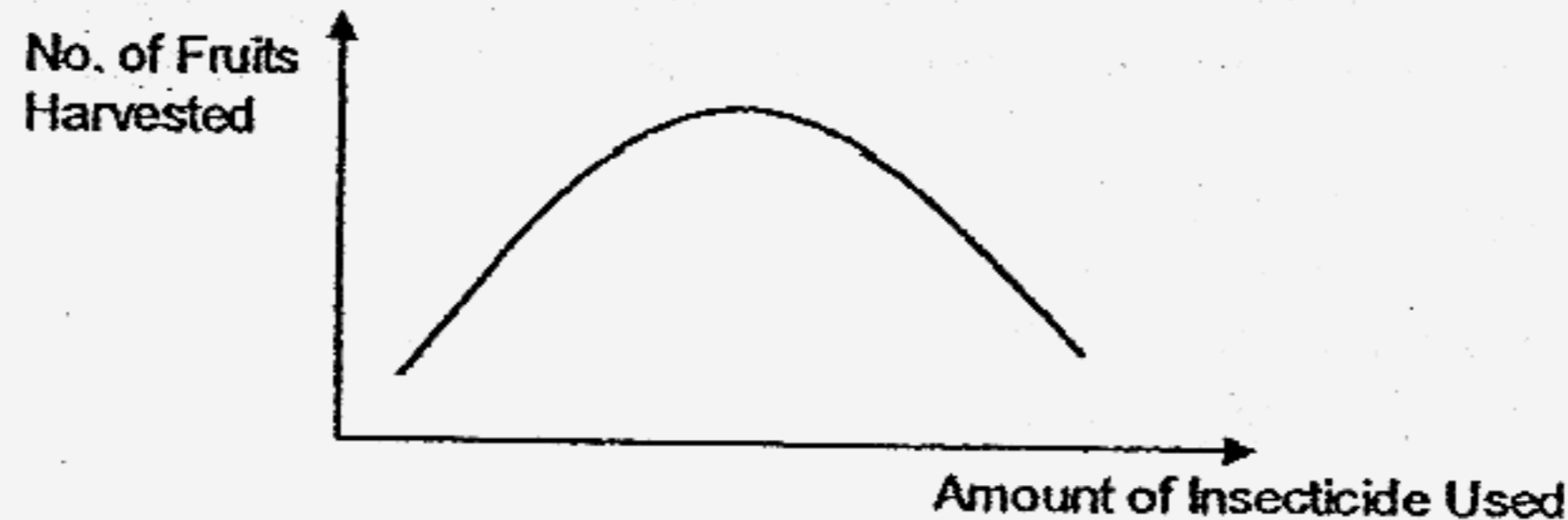

- A The number of fruits obtained increased when less insecticide is used.
- B The number of fruits obtained keeps on increasing when more insecticide was used.
- C Lesser fruit is obtained when too little insecticide is used.
- D When too much insecticide is used, the number of fruits obtained is less.

- (1) A and B only
- (2) A and C only
- (3) B and D only
- (4) C and D

14. A camel is well suited to live in the desert. Which of the statement is **true** about the camel?

- A Long eye lashes that prevent sand from being blown into its eyes.
- B Padded feet that shield its feet from the hot ground.
- C Humps that store large amounts of water.



- (1) A and B only
- (2) A and C only
- (3) B and C only
- (4) A, B and C

15. A farmer who sold wool had sheep with coarse hair among the wool on their bodies. He wanted to produce new sheep with soft and fine wool by using genetic selection. If the genetic selection was successful, which one of the following would **NOT** be a benefit produced?

- (1) The farmer would not need to spend extra time removing the coarse hair.
- (2) The new sheep would be able to stay cool in warm weather.
- (3) More people would buy the wool produced by the new sheep.
- (4) The clothing made from the wool produced by the new sheep would feel more comfortable and softer.

16. Shanna added 50g of salt to a beaker containing 200g of water. The beaker weighs 150g when empty. She stirred the mixture vigorously until all the salt had dissolved. Next she placed the beaker on a burner to evaporate all the liquid in the beaker. Then, she placed the beaker on the weighing scale again.

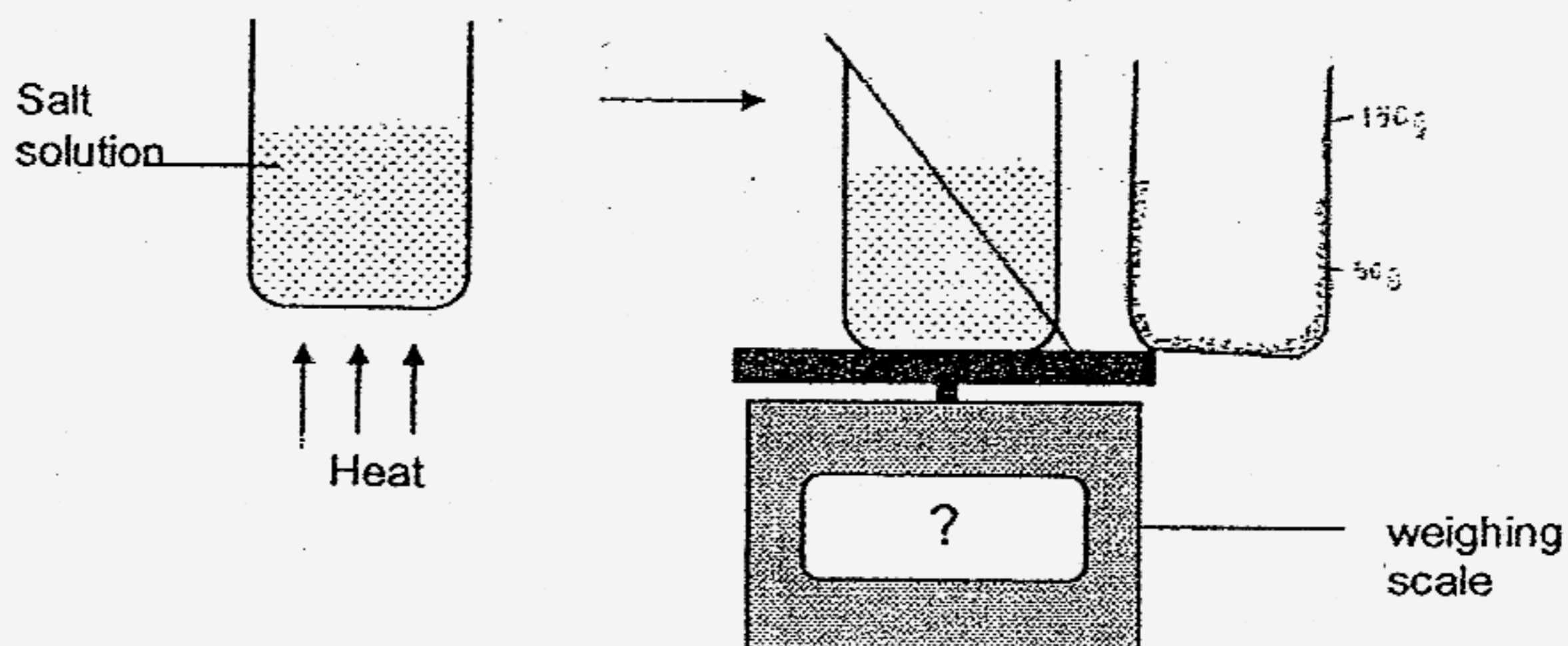

What is the new reading on the scale?

- | | |
|-----------|-----------|
| (1) 50 g | (2) 150 g |
| (3) 170 g | (4) 200 g |

17. The diagram below shows the 3 substances X, Y and Z.

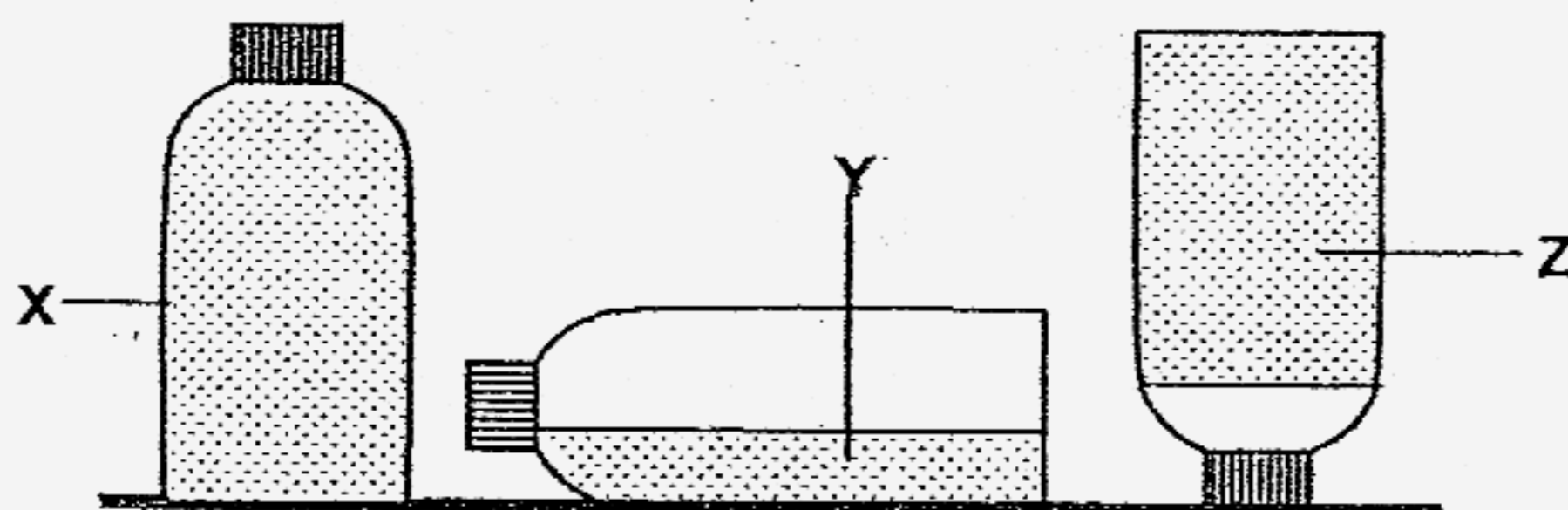

Based on what you can see only, which of the following statements are definitely true?

- A: Substance Z is a solid.
 B: Substance Y is water.
 C: Substance Y has a definite volume.
 D: Substances X, Y and Z are the same substance at different states.

- | | |
|---------------------|---------------------|
| (1) A and C only | (2) B and D only |
| (3) A, B and D only | (4) A, C and D only |

18. The diagram below shows a spring being stretched to different lengths using different loads.

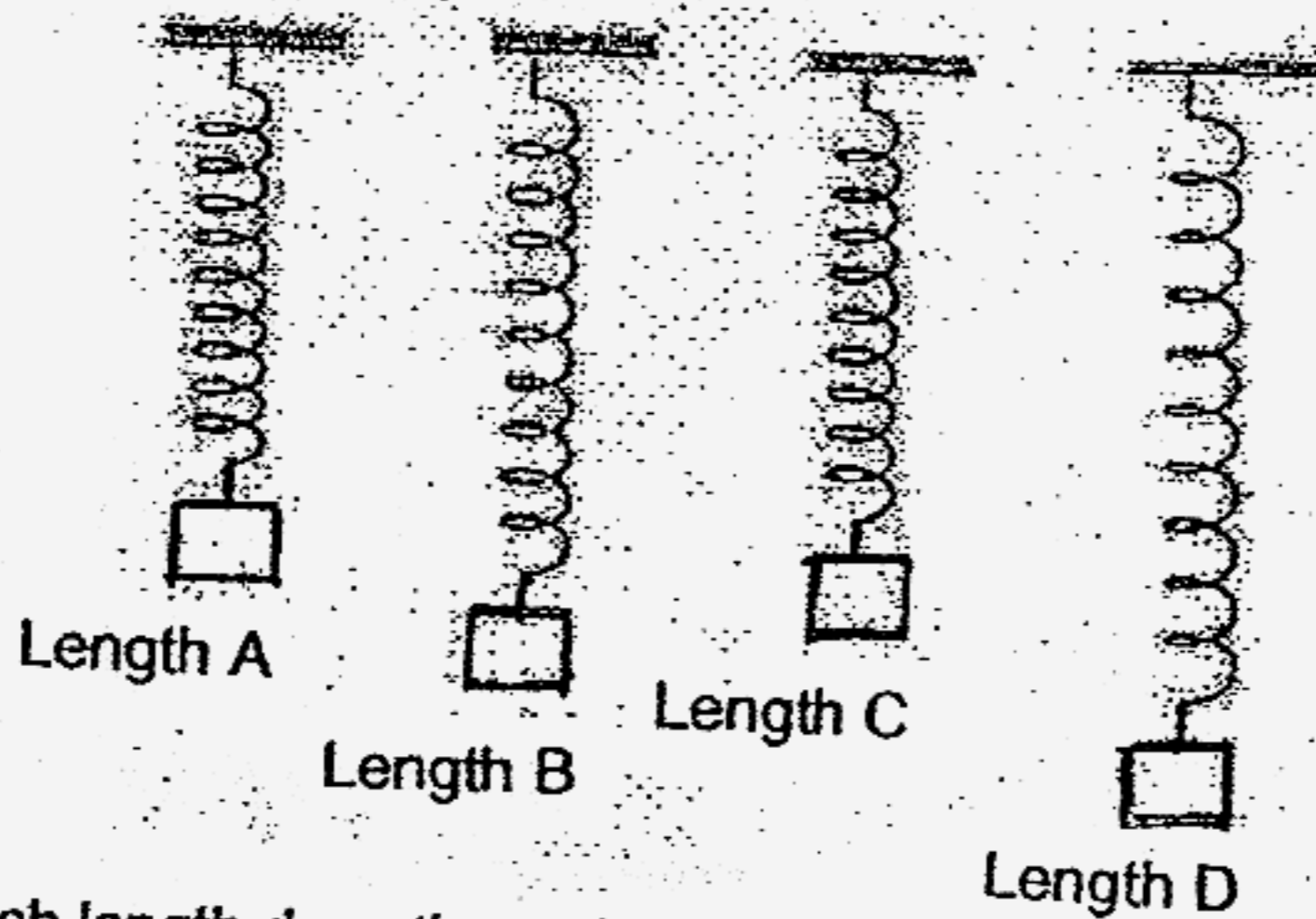

At which length does the spring possess the greatest elastic potential energy?

- (1) A
(2) B
(3) C
(4) D
19. Kern carried out an experiment to find out the number of times the key to a toy car is turned and the distance it travelled. He placed the car at the same starting point, S each time. The track which the car followed was horizontal for 200cm followed by a gentle slope starting at point T.

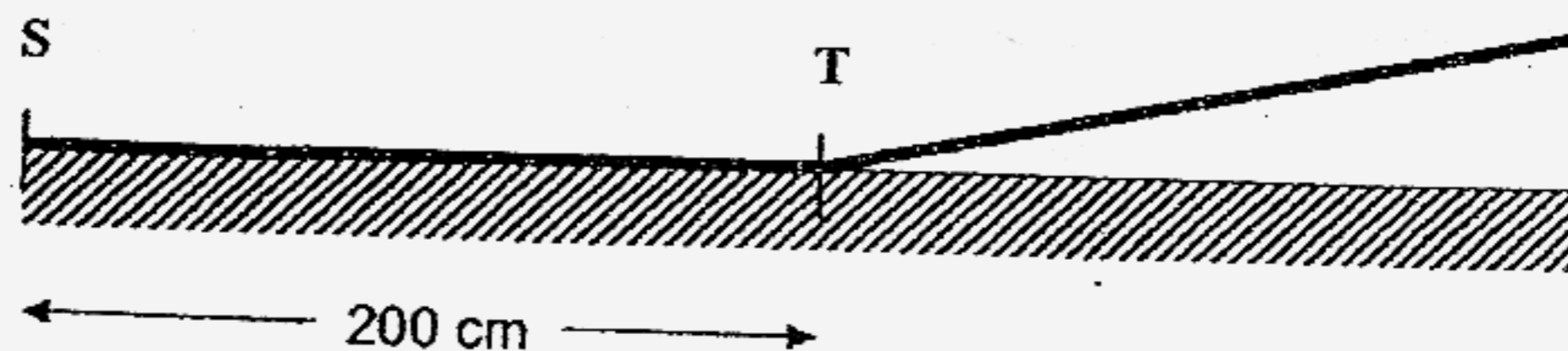

The results of his test were recorded in the table below:

Number of turns of the key	2	4	6	8	10
Average distance travelled (cm)	50	100	150	200	

Predict the average distance (in cm) travelled by the car as it moves up the slope when Kern made 10 turns on the toy car.

- (1) 200
(2) 220
(3) 250
(4) 300

20. The diagram below shows a man playing golf. He has to swing both his arms to the side simultaneously to hit the ball with his golf club.

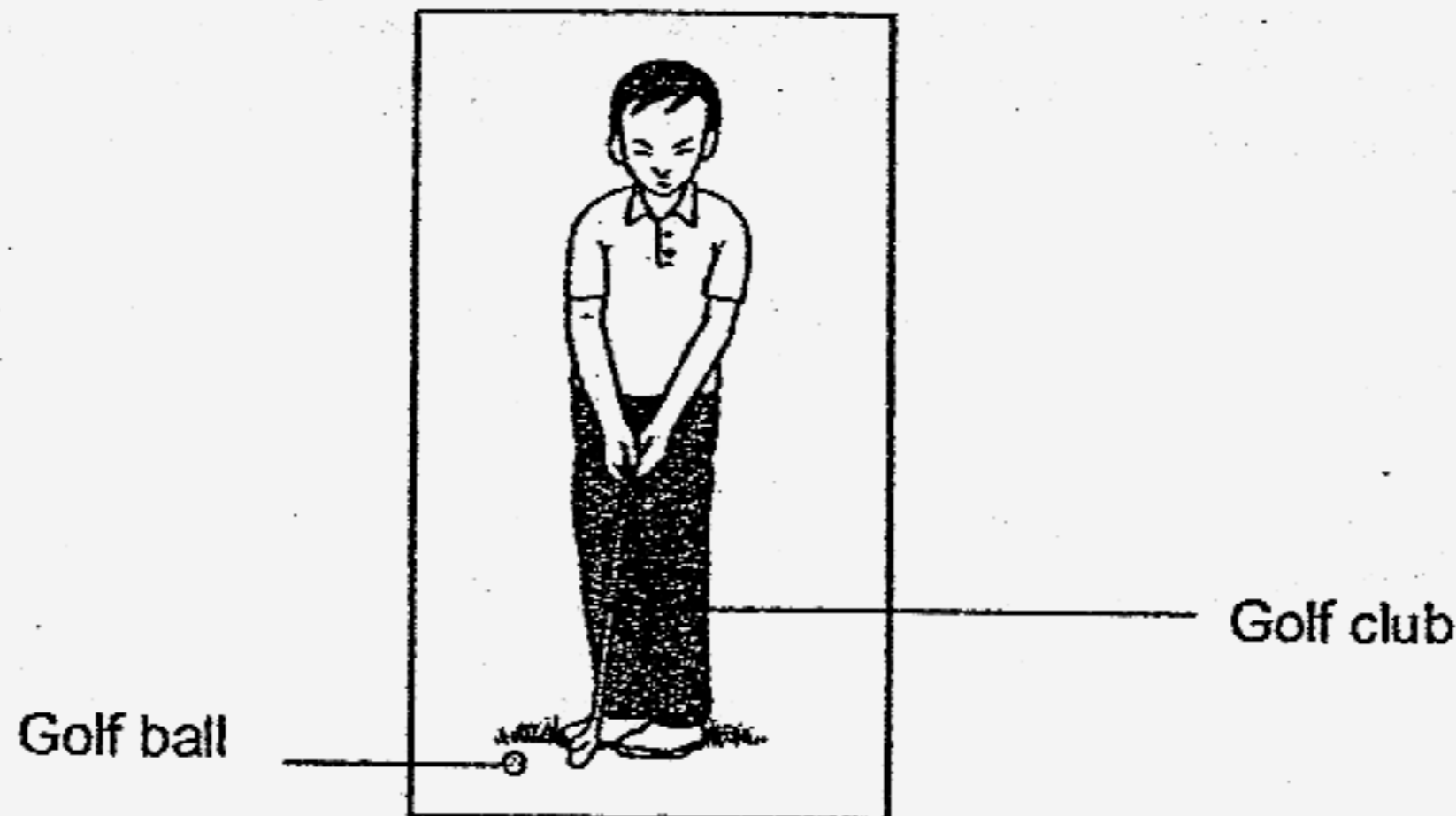

Which one of the following correctly identifies the effort, fulcrum and load?

	Effort	Fulcrum	Load
1.	Arm and Hand	Body	Golf club
2.	Body	Arm and Hand	Ball
3.	Arm and Hand	Body	Ball
4.	Golf club	Arm	Ball

21. Study the set-up below carefully.

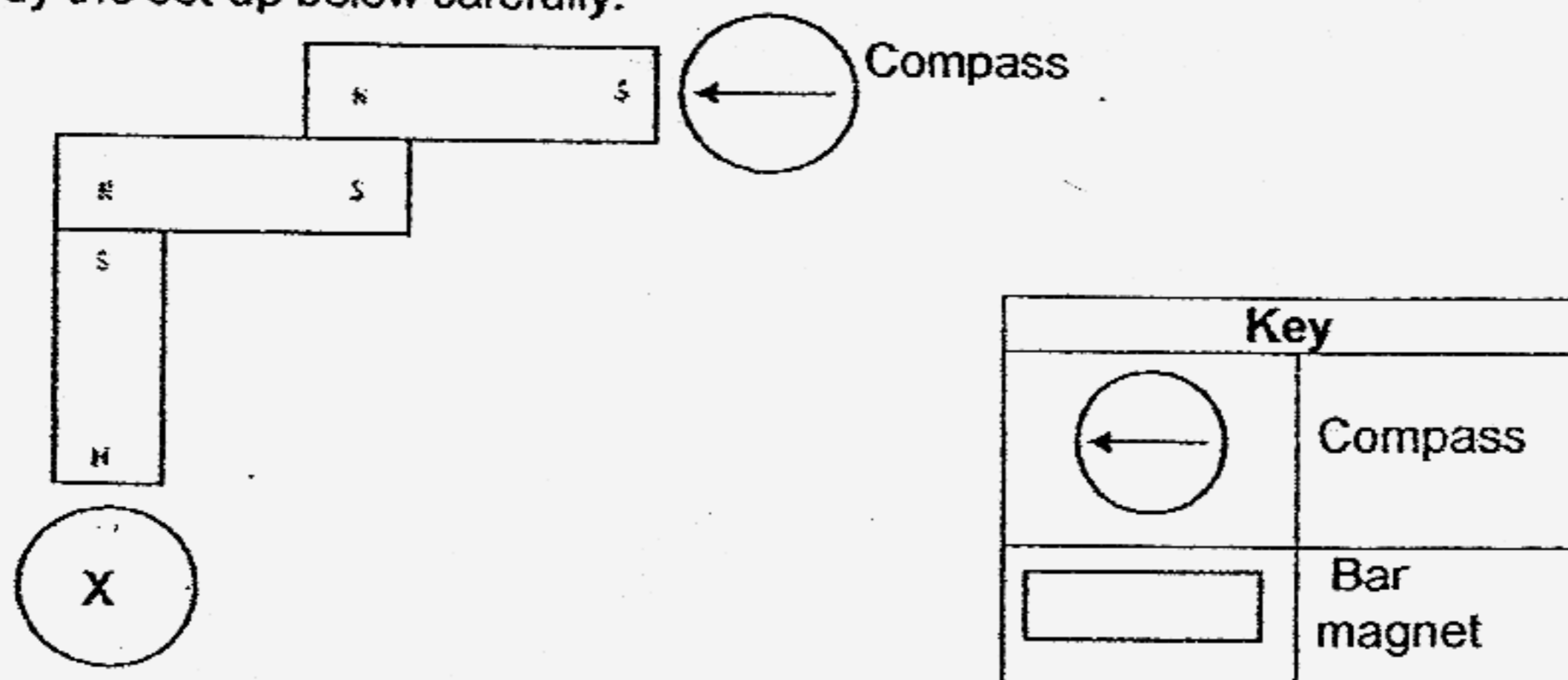

Which one of the following compasses correctly represents compass X in the above set up?

- (1)
- (2)
- (3)
- (4)

22. The experiment shown below was carried out in a dark room. A clear plastic, a tracing paper, a clear glass and a copper sheet were placed at various distances from the source of light. An opaque object was placed between the torch and material A.

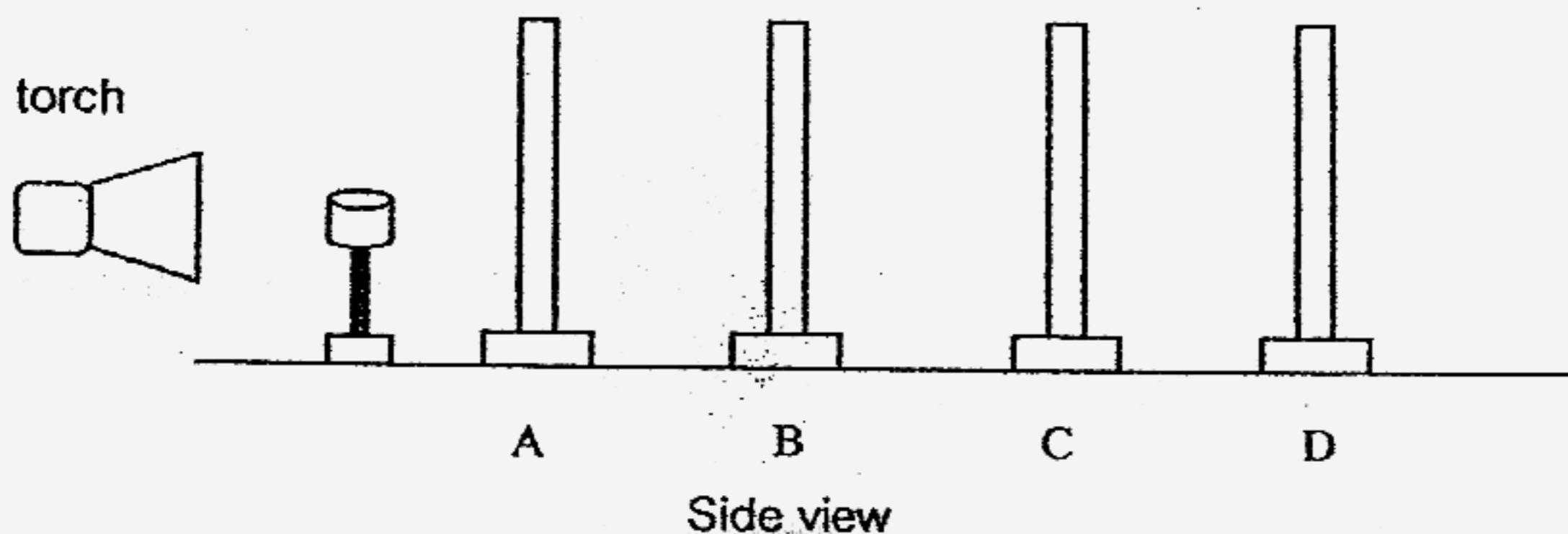

When the torch was switched on, a dark shadow was seen on sheet C only.

Which one of the following shows a possible arrangement of the materials?

	A	B	C	D
(1)	Clear Plastic	Tracing Paper	Clear Glass	Copper Sheet
(2)	Clear Glass	Clear Plastic	Tracing Paper	Copper Sheet
(3)	Clear Glass	Copper Sheet	Clear Plastic	Tracing Paper
(4)	Clear Plastic	Clear Glass	Copper Sheet	Tracing Paper

- 23 Study the diagram below carefully.

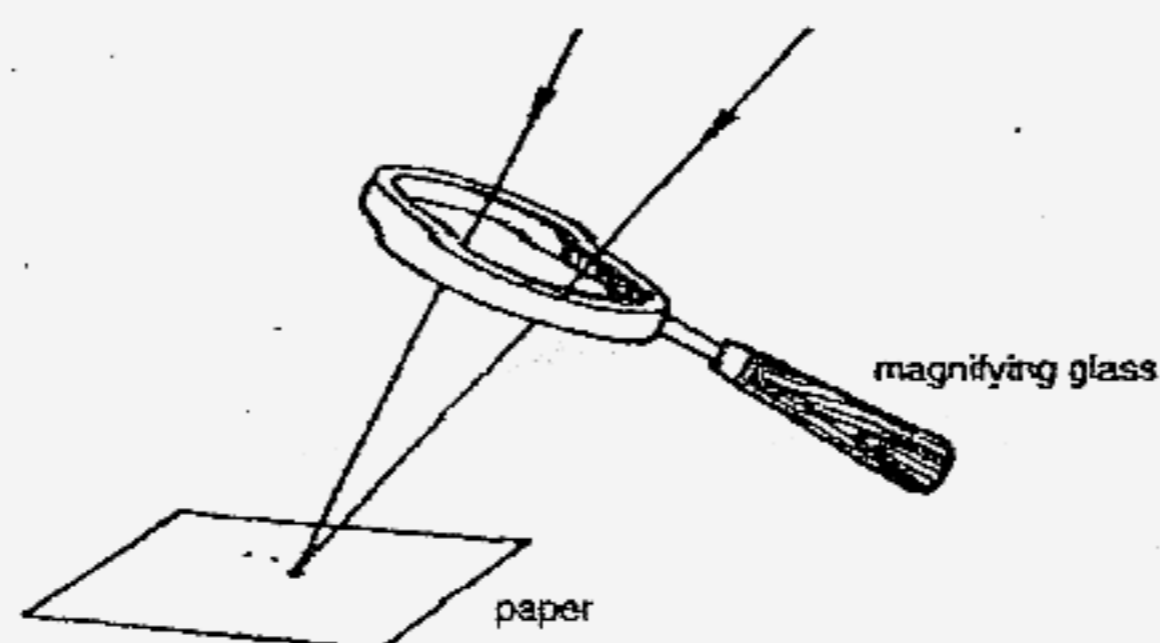

What energy conversion has caused the paper to have burn marks on the paper?

- (1) Solar energy \implies light energy.
 (2) Light energy \implies heat energy.
 (3) Heat energy \implies light energy
 (4) Light energy \implies chemical potential energy.

24. Study the classification chart below carefully.

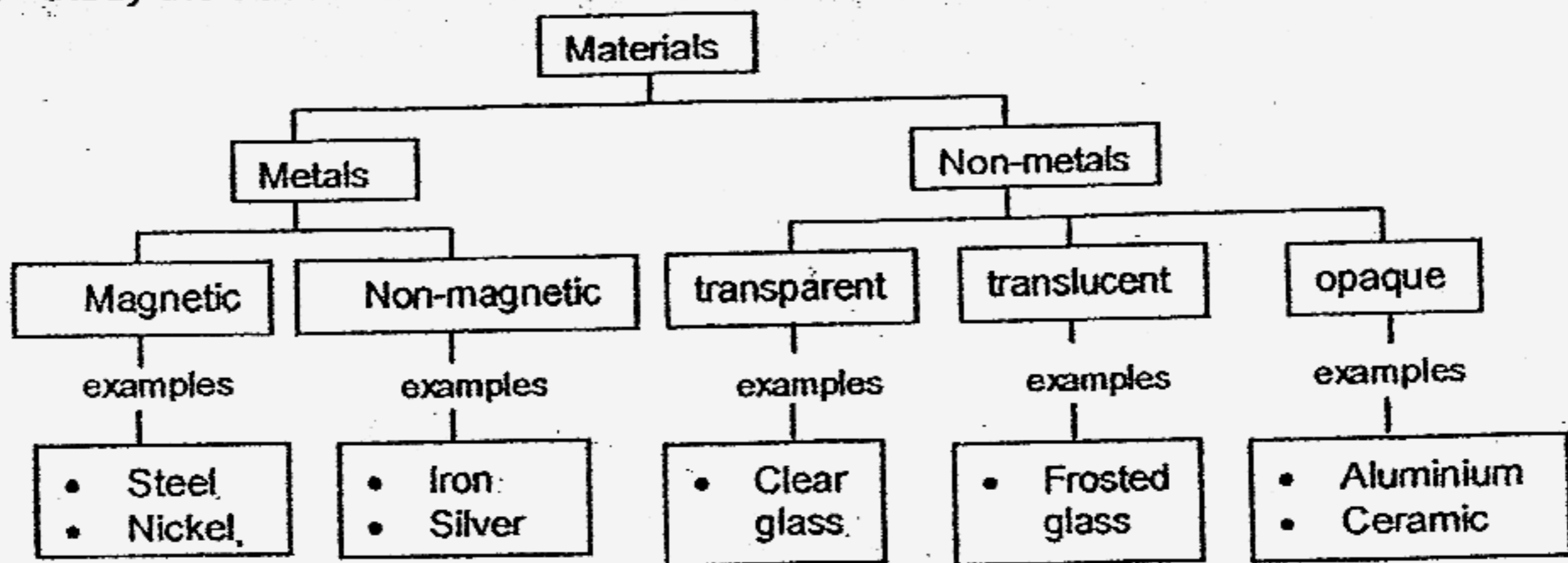

Which of the above materials are **wrongly** classified?

- (1) Nickel, iron and silver.
- (2) Iron, silver and aluminium
- (3) Nickel and frosted glass
- (4) Iron and aluminium

25. The picture below shows the Sun as viewed from Earth at daytime during a solar eclipse.

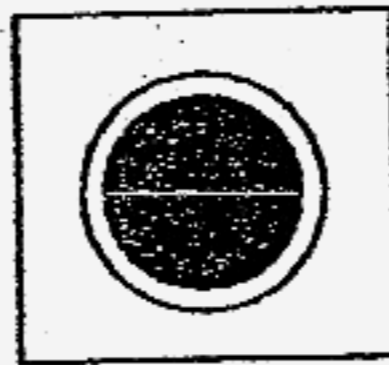

Which one of the diagrams below shows the **correct** representation of the positions of the Earth, Moon and Sun in our solar system during a solar eclipse?

(1)			
(2)			
(3)			
(4)			

- 26 Mei Ling used two simple machines to study the relationships between the load and the effort. She recorded her observation and plotted the graph below.

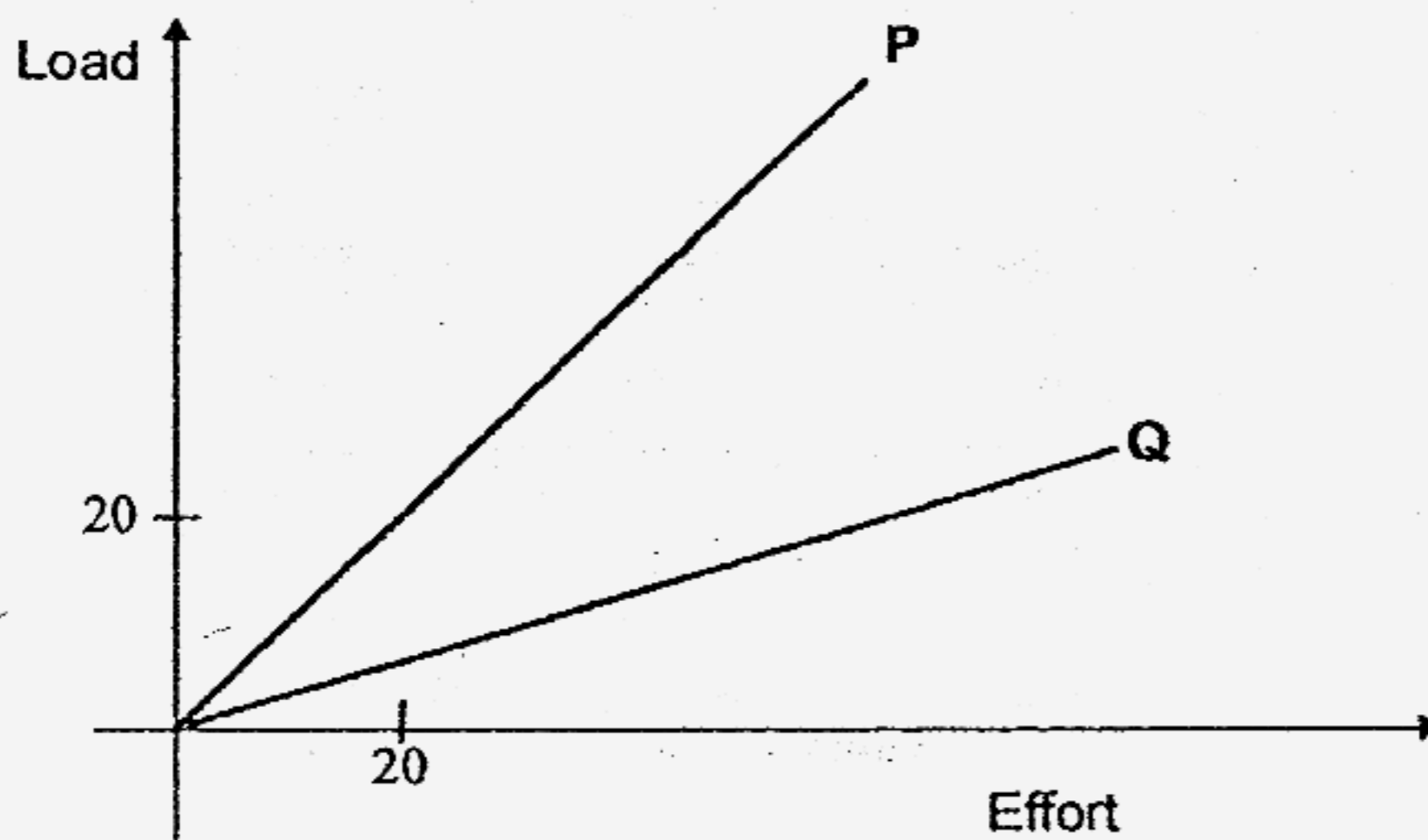

Match the two machines to the lines P and Q on the graph above.

	P	Q
(1)	A fixed pulley	A movable pulley
(2)	A see saw	A fishing rod
(3)	A claw hammer	A ramp with an angle of inclination of 80° .
(4)	A fixed pulley	A ramp with an angle of inclination of 30° .

27. Study the diagram below carefully.

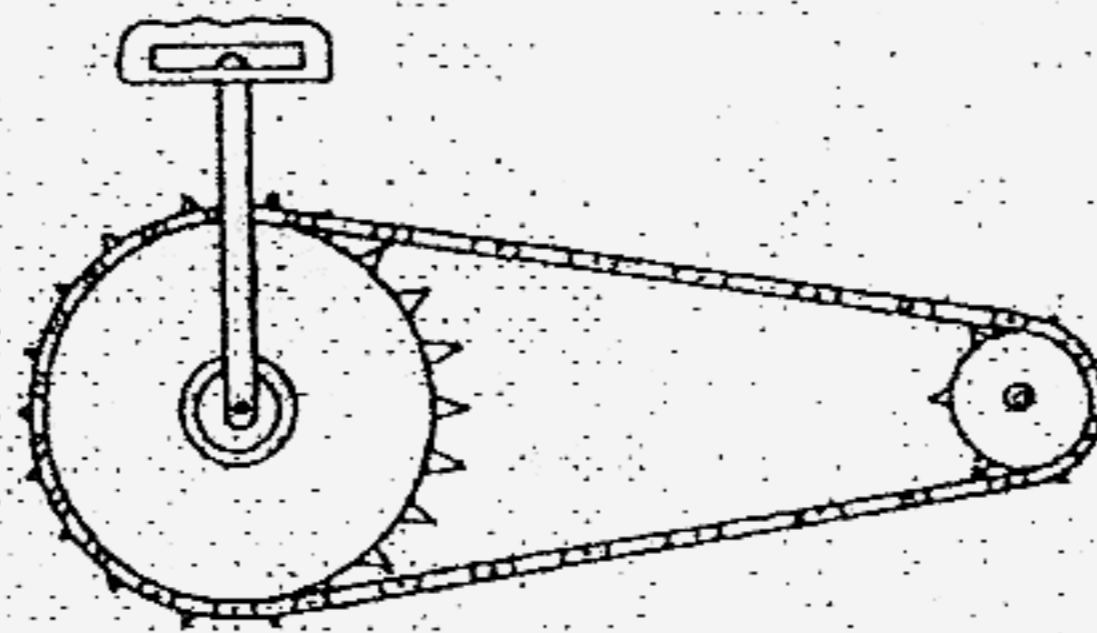

When the big gear turns one round, what will happen to the small gear?

- (1) It will turn more rounds in the same direction.
- (2) It will turn more rounds in the opposite direction.
- (3) It will turn less rounds in the same direction.
- (4) It will turn less rounds in the opposite direction.

28. Three new batteries and a new bulb are used to form the following circuits.

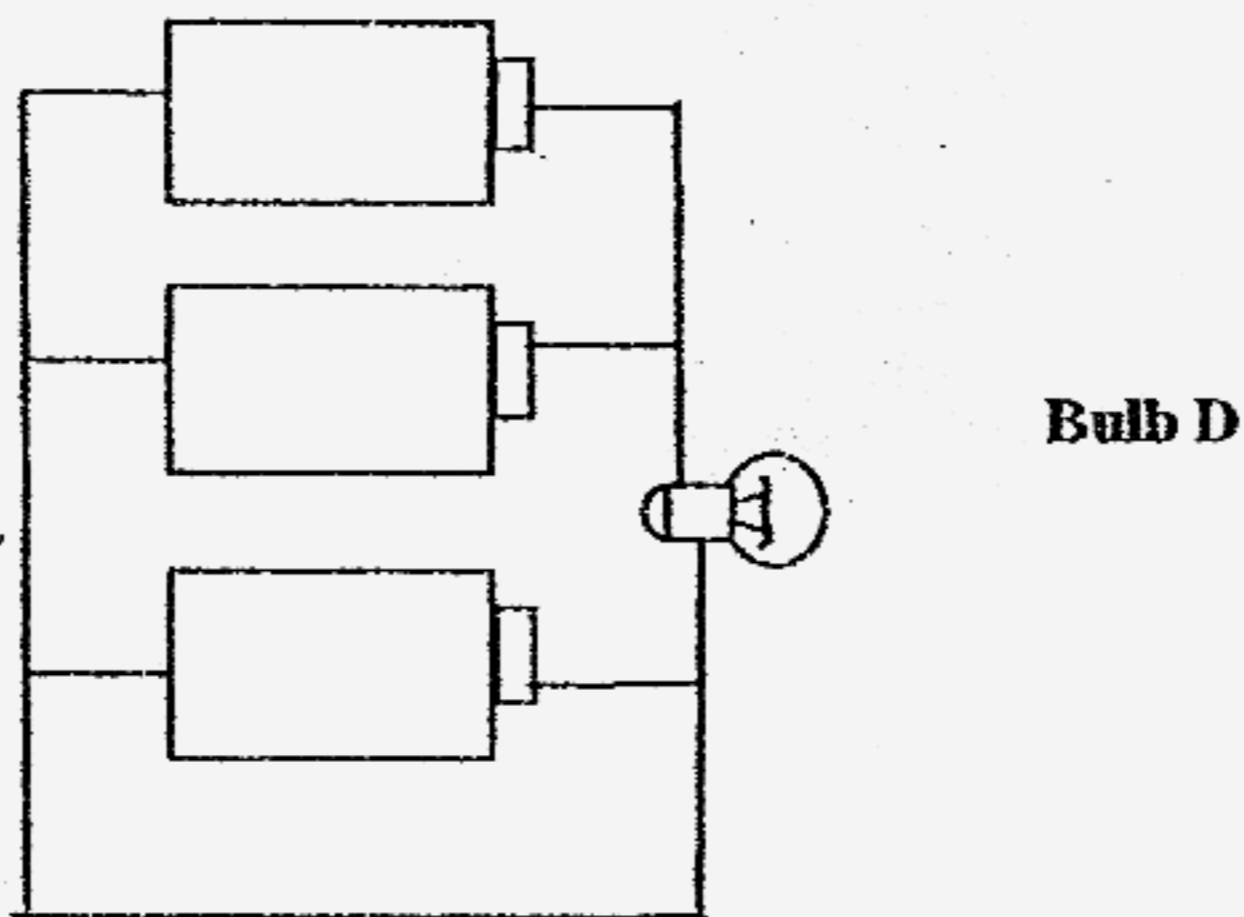
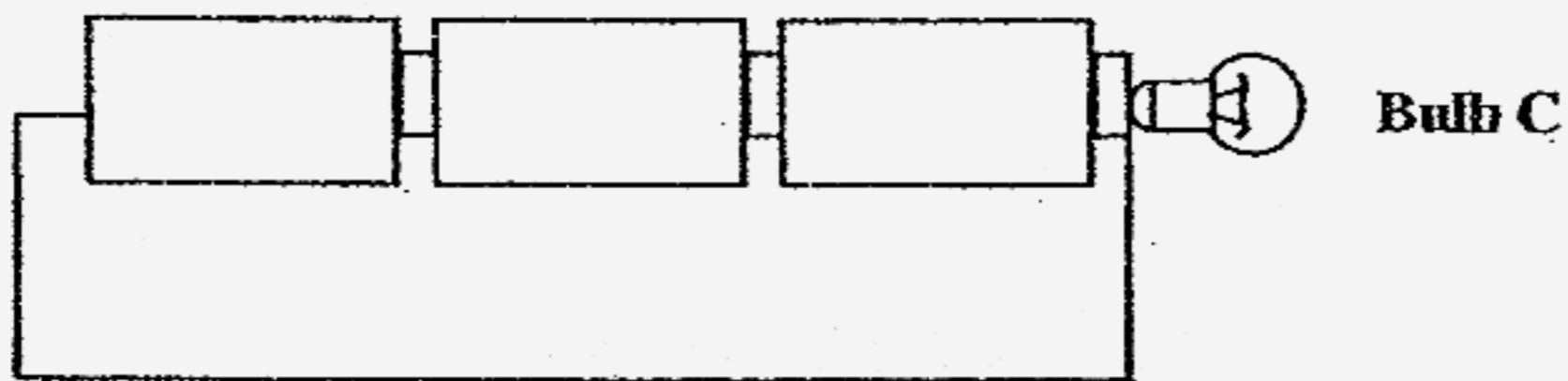
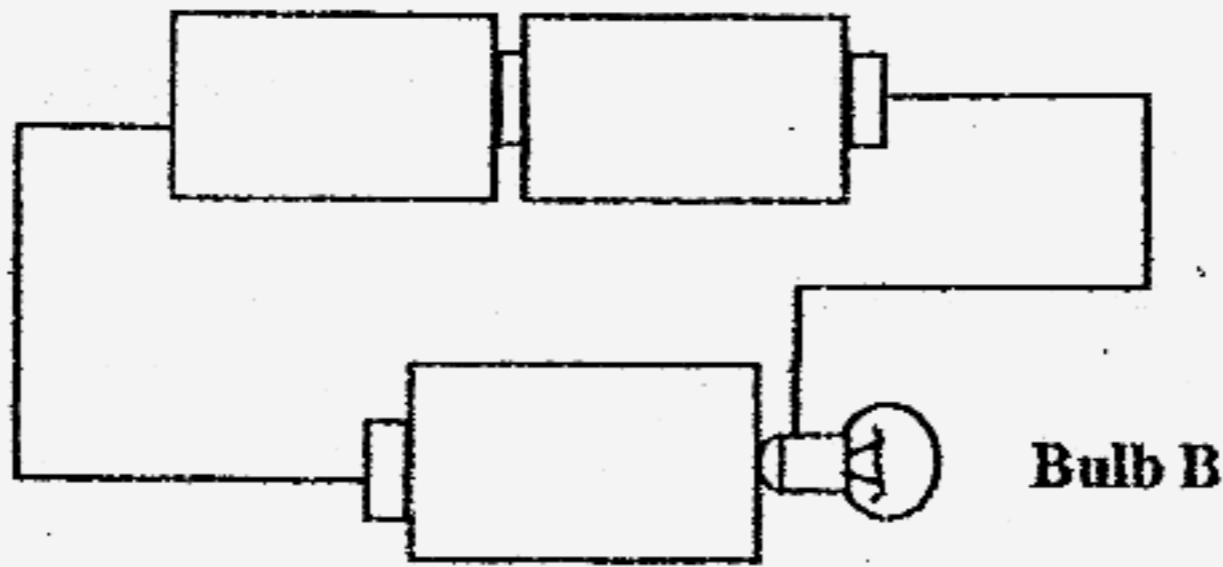
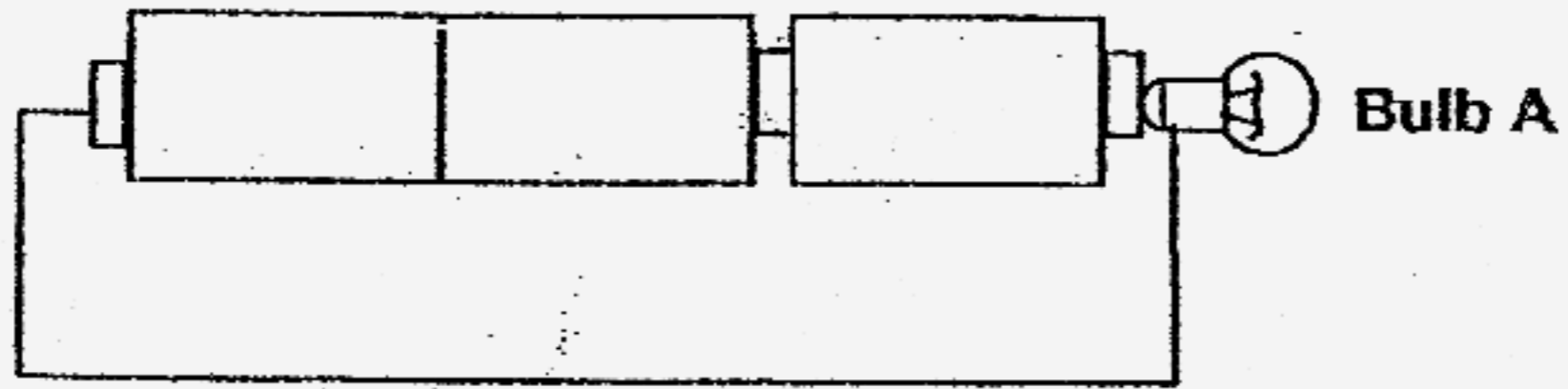

Which of the above bulbs will light up?

- (1) B only
- (2) A and B only
- (3) A and C only
- (4) B, C and D only

29. Study the diagram below carefully.

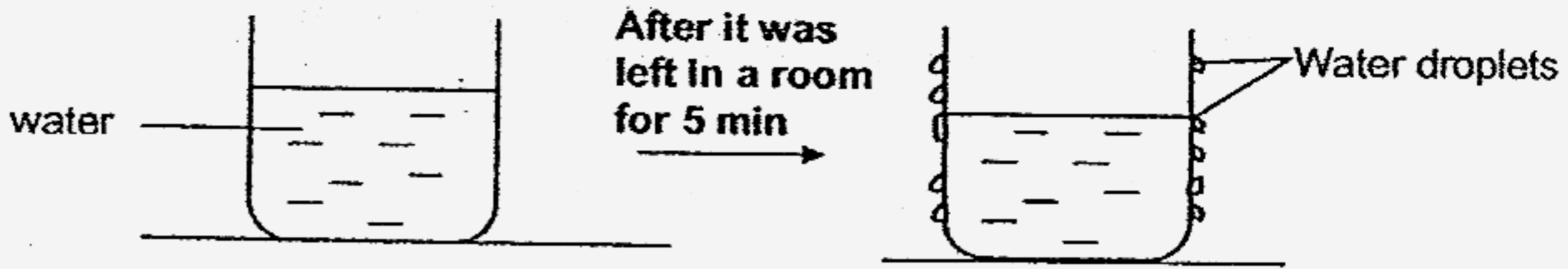

What inferences can be made based on the experiment above?

- A: Condensation has taken place.
- B: Heat is lost by the surrounding air to the beaker.
- C: The water droplets are formed from the water in the beaker.
- D: The room temperature is higher than the temperature of the water at the start of the experiment.

(1) A and C only

(2) B and D only

(3) A, B and D only

(4) A, C and D only

30. The girl below was standing in front of a mirror with a word card.

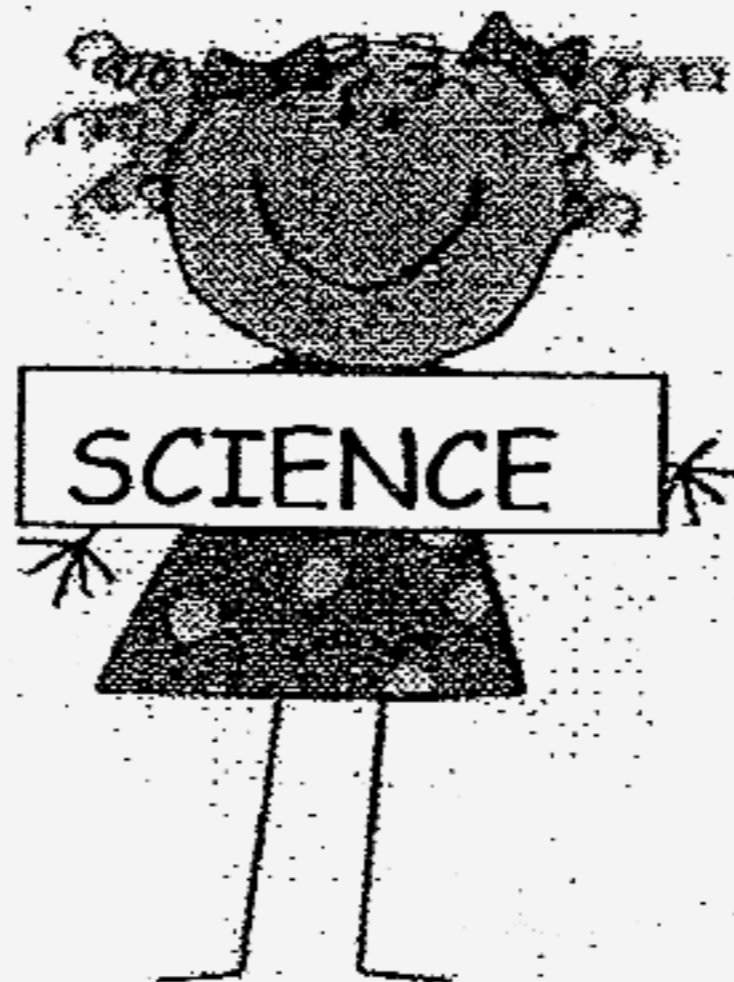

Which one of the following correctly shows the mirror image of the word "SCIENCE"?

(1) 2SCIENCE

(2) SCIENCE

(3) SCIENCE

(4) SCIENCE

Index Number

						-	
--	--	--	--	--	--	---	--

NAN HUA PRIMARY SCHOOL
PRIMARY SIX PRELIMINARY EXAMINATION 2006
SCIENCE
BOOKLET B

Name: _____

Class: Primary 6 _____

Date: _____

DO NOT OPEN THIS BOOKLET UNTIL YOU ARE TOLD TO DO SO.

31. George set up an experiment as shown below. He filled a plastic bag with starch solution. The bag is placed into a beaker containing water with some brown iodine solution. He then left it overnight.

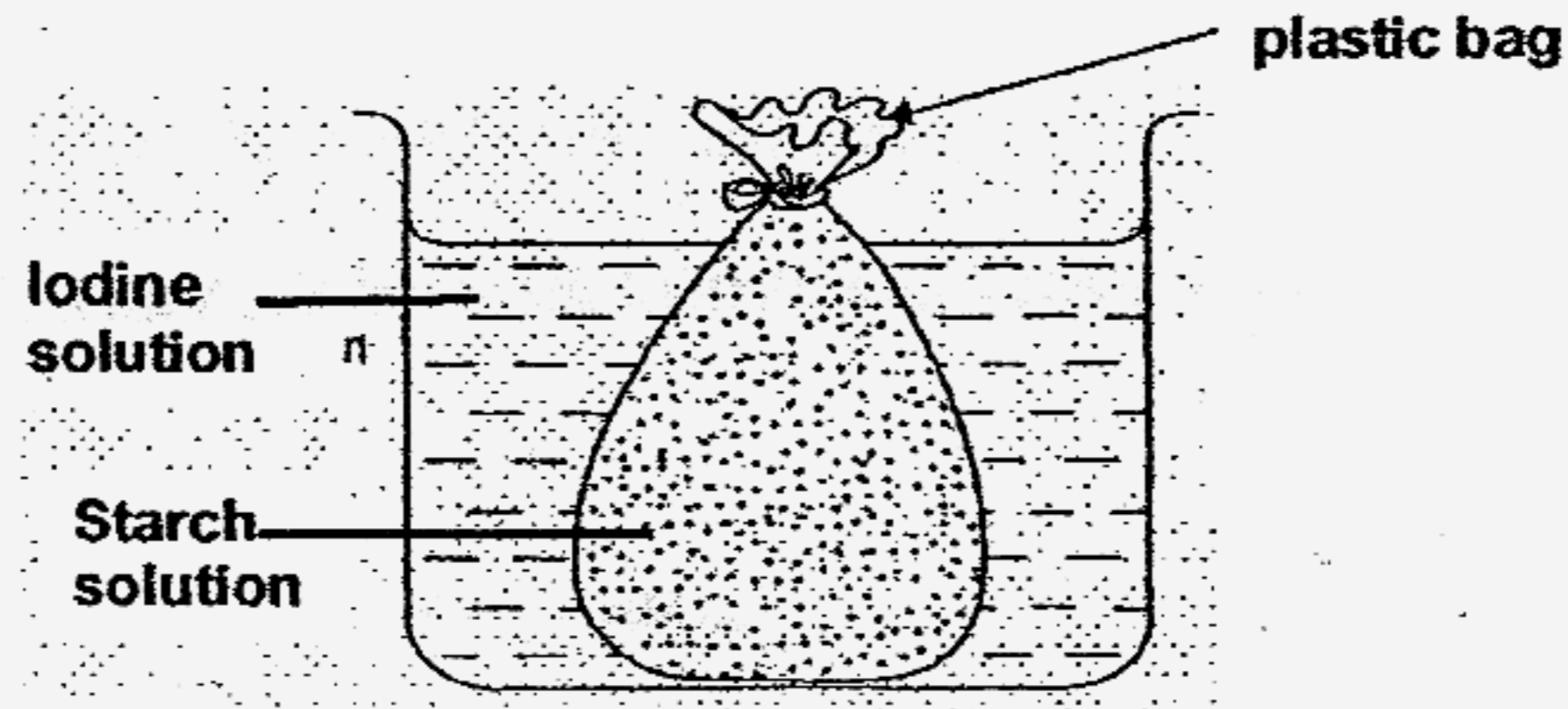

The next day, George observed that the starch solution in the plastic bag had turned dark blue.

a) Why did the starch solution turn dark blue and not the iodine solution? (1m)

b) Which part of the plant cell exhibits the above property mentioned in (a)? (1m)

32.

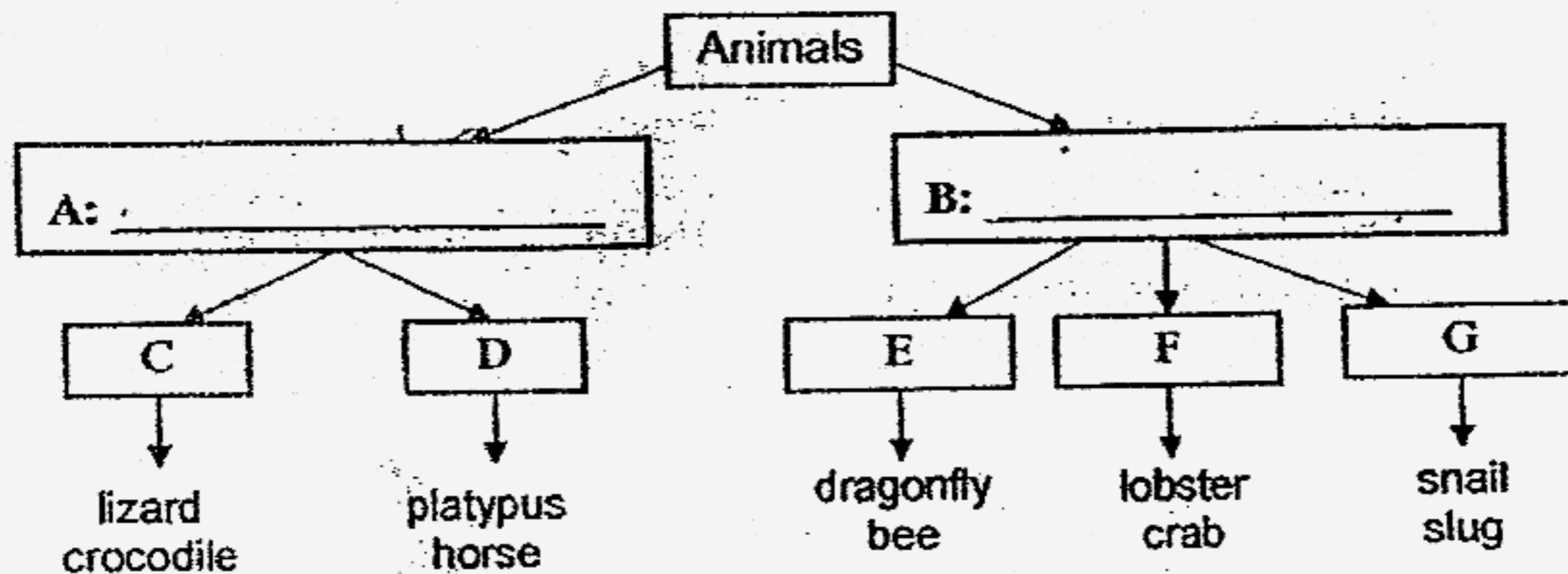

a) How are the animals being classified? Write down your answers in the boxes provided above. (1m)

b) In which group, C, D, E, F or G would you place the following animals? (1m)

i) Woodlouse: Group _____

ii) Bat: Group _____

33.

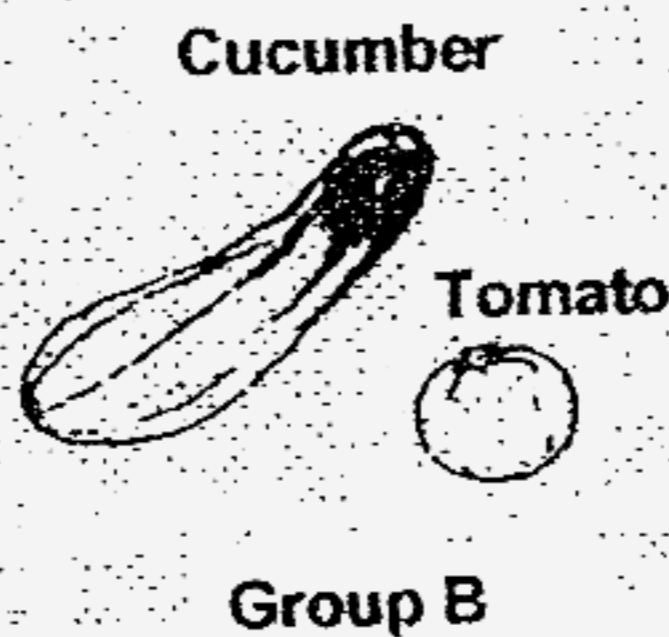
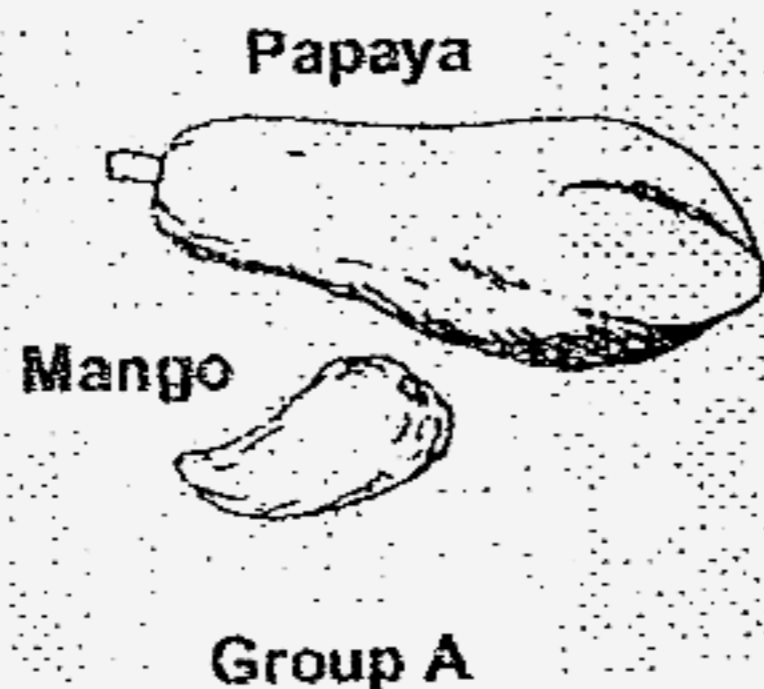

a) In what way are the plants that produce these two groups of fruit similar? (1m)

b) The fruits of both groups above are edible and eaten by animals. However, there is a difference in the way their seeds are scattered. What is the difference? (2m)

34. Kandy wanted to find out what type of soil was suitable for growing a balsam plant. She planted 3 balsam plants of similar size in 3 pots X, Y and Z.

	Pot X	Pot Y	Pot Z
Material of Pot	Plastic	Plastic	Plastic
Type of Soil	Clayey	Garden	Sandy
Amount of Soil	1500g	1000g	800g
Amount of Water (daily)	150cm ³	150cm ³	150cm ³

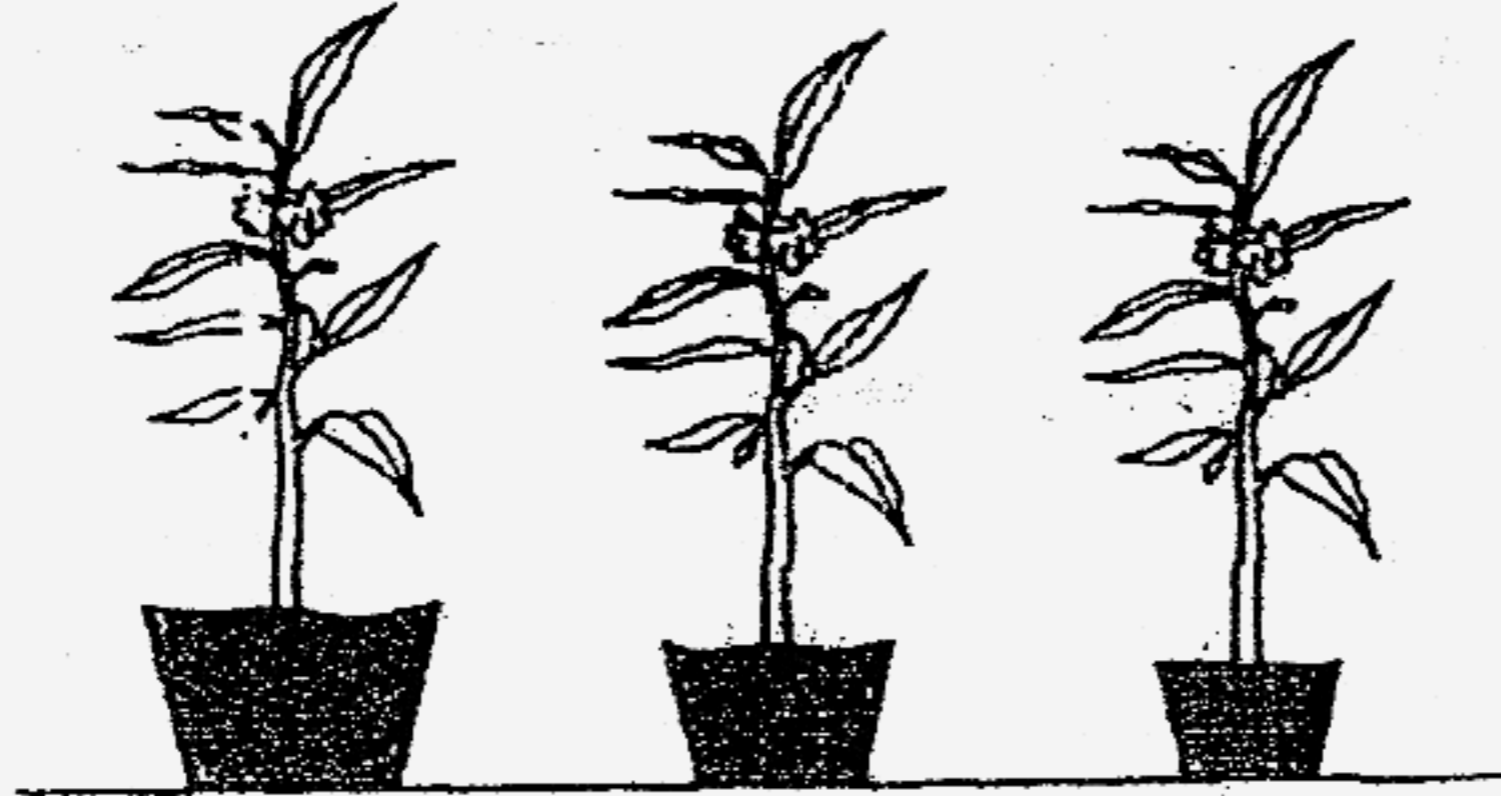

- a) Why was the experiment not a fair one? (1m)

- b) If Kandy solved the problem in (a), which soil do you think will be best and why? (2m)

35. The diagram below shows a working model of a human chest. A rubber sheet is stretched across the bottom of the bell jar and tied firmly in place.

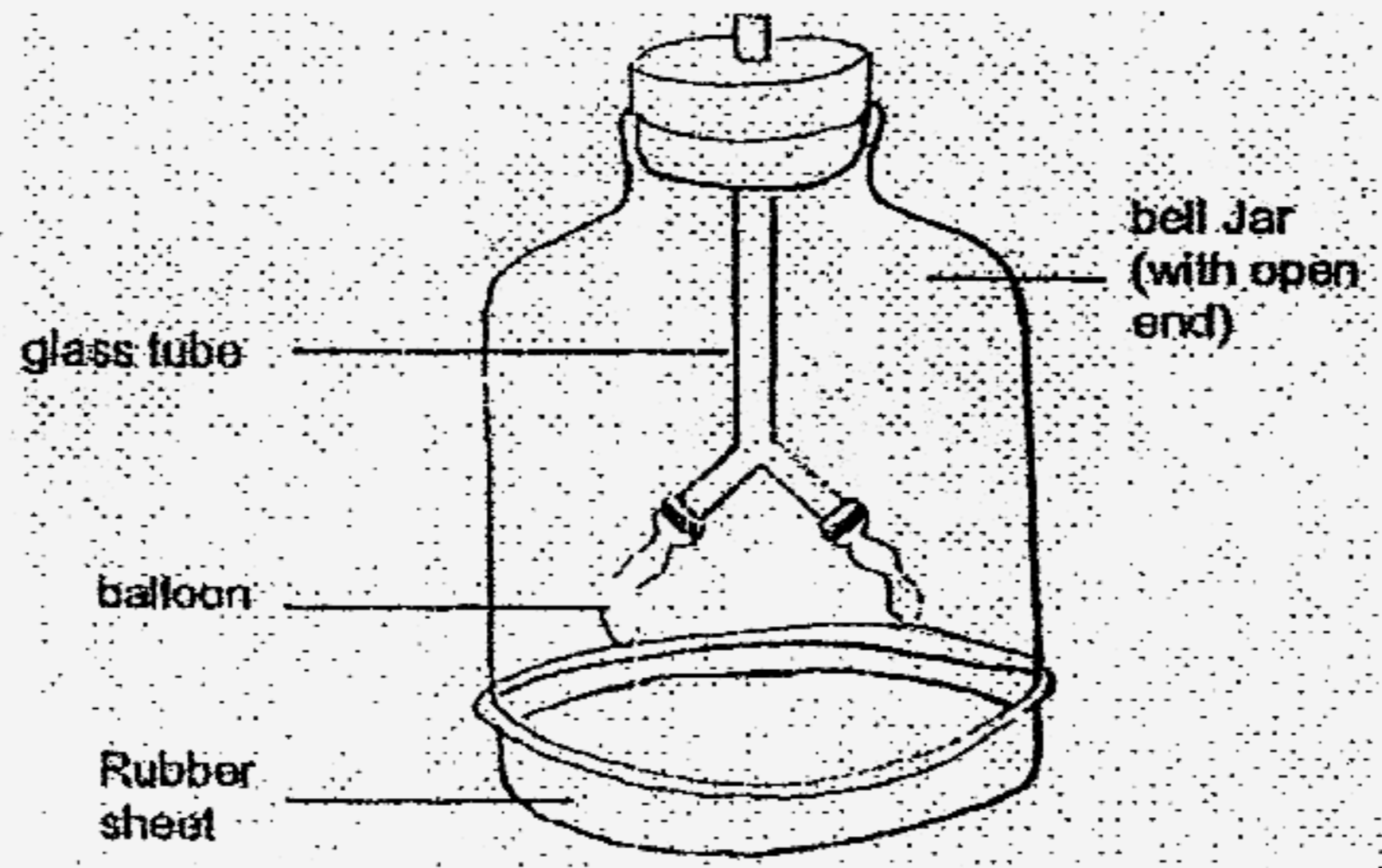

a) Which parts of our respiratory system do the following parts of the model represent? (1m)

Model	Respiratory System
Glass Tube	
Balloons	

b) What would you observe in the bell jar when the rubber sheet at the end of the jar was pulled and then let go? (1m)

36. Xiao Long placed Setup A and B below in a room at 30°C for three weeks.

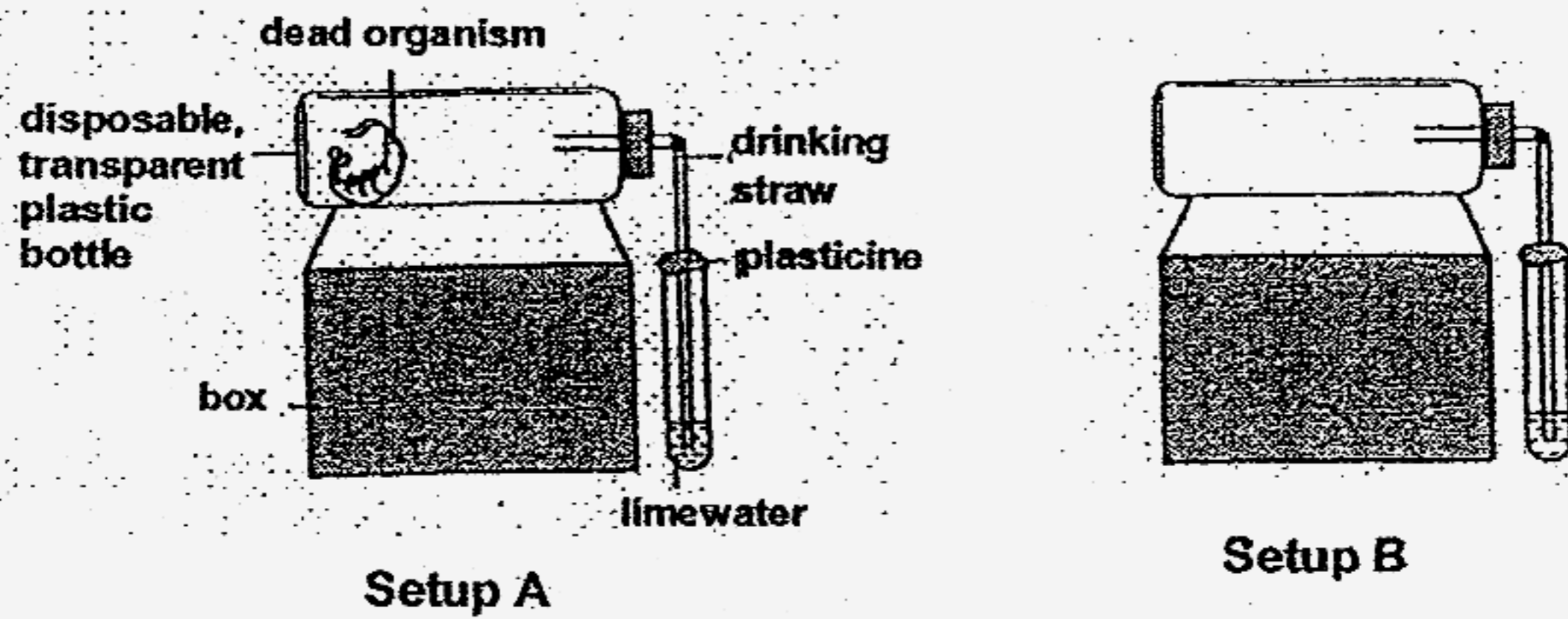

a) What is Xiao Long trying to find out from the experiment? (1m)

b) Why is the process, which the prawn is undergoing, important to the environment? (2m)

37. Yun Da set up an experiment as shown below.

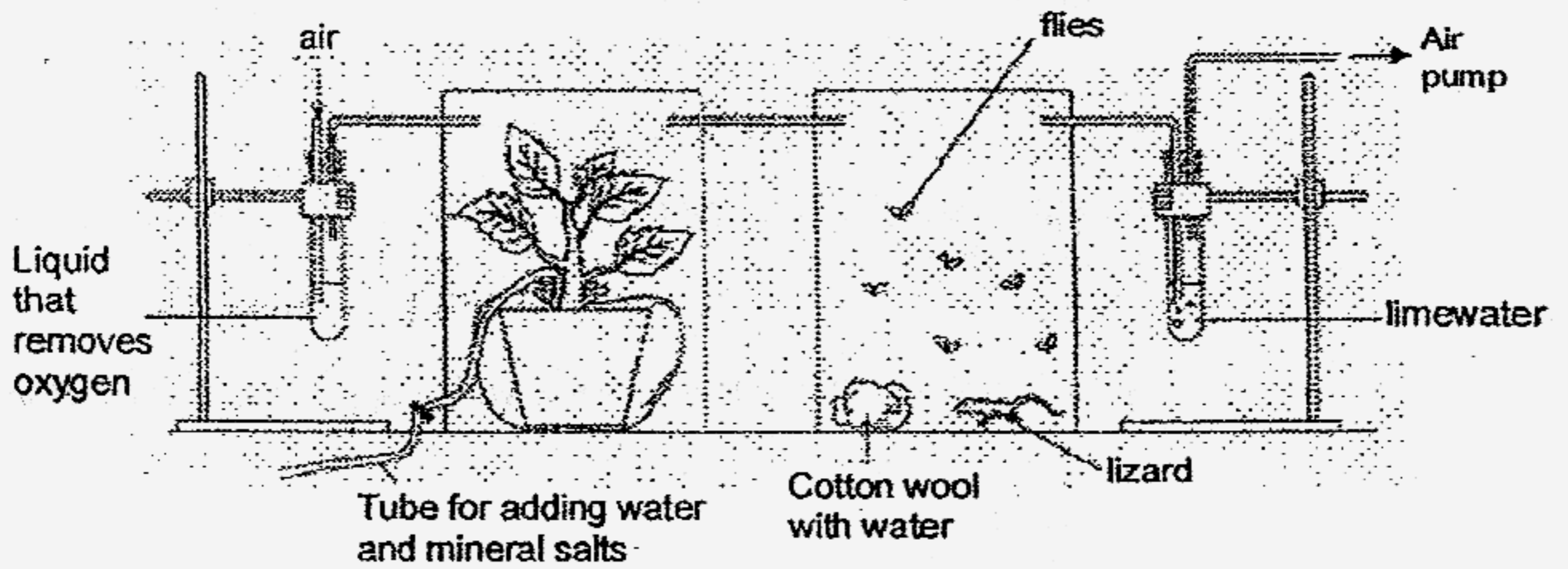

a. b) State the condition which is not shown in the diagram but is necessary for the survival of the plant and animals in this experiment. (1m)

b. e) How does the condition stated in (a) help the plant and animals to survive?(1m)

c. d) What does this experiment show about the relationship between plants and animals? (1m)

38. In the food chain as shown below, P, Q and R represent organisms in the field.



A large population of a herbivore is introduced into the field. They feed on P but are not eaten by R.

(i) Draw a line graph below to show what happens to the population of P. (1m)

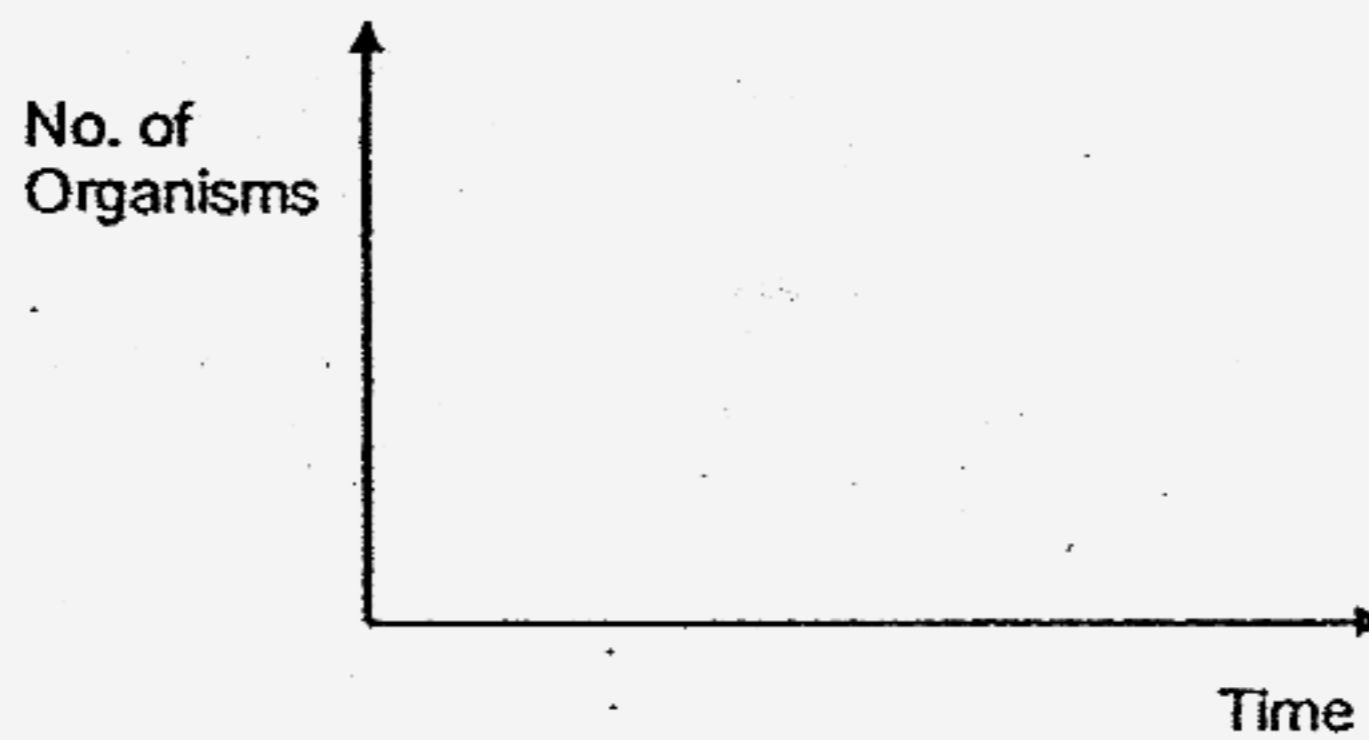

(ii) What will happen to the population of Q, if Q only feeds on P? (1m)

39. In a circus show, male acrobat **A** performs a somersault as shown below. Acrobat **A** gets his energy indirectly from the female acrobat **B**.

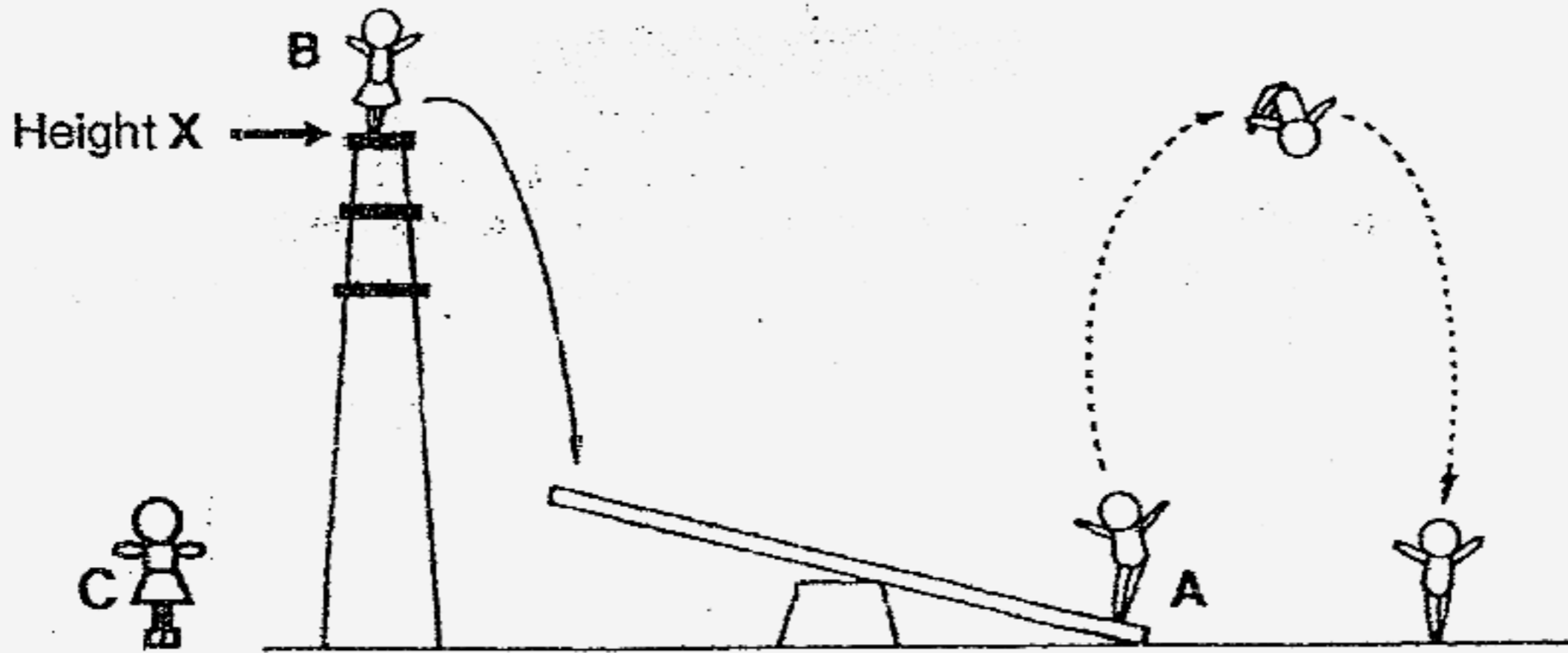

- (a) What could acrobat **B** do to help acrobat **A** perform his somersault at a greater height? (1m)

- (b) When acrobat **B** was replaced by acrobat **C**, it was noticed that Acrobat **A** jumped to a greater height ~~below~~ coming down. Explain this observation. (Both acrobats **B** and **C** jumped from height **X**.) (2m)

40. A bimetallic strip consists of two metals which expand differently when heated.

The bimetallic strip below consists of two metals, X and Y.

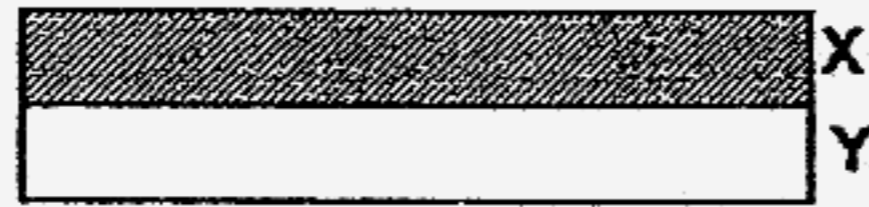

a) Metal Y expands more than metal X after heating.

Draw how the bimetallic strip would look like after heating in the box provided below. (1m)

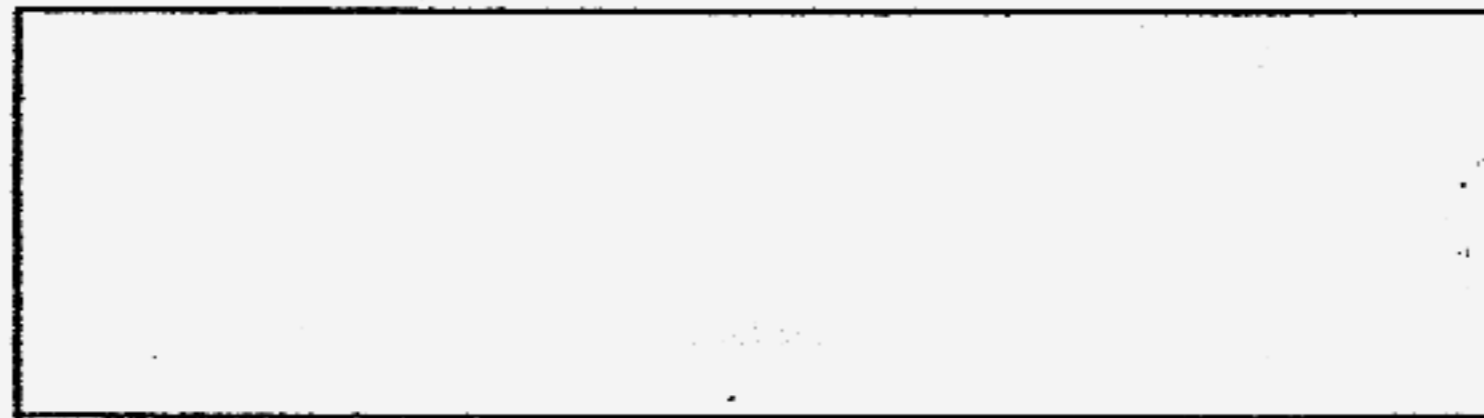

b) The same bimetallic strip is used in the fire alarm system shown below.

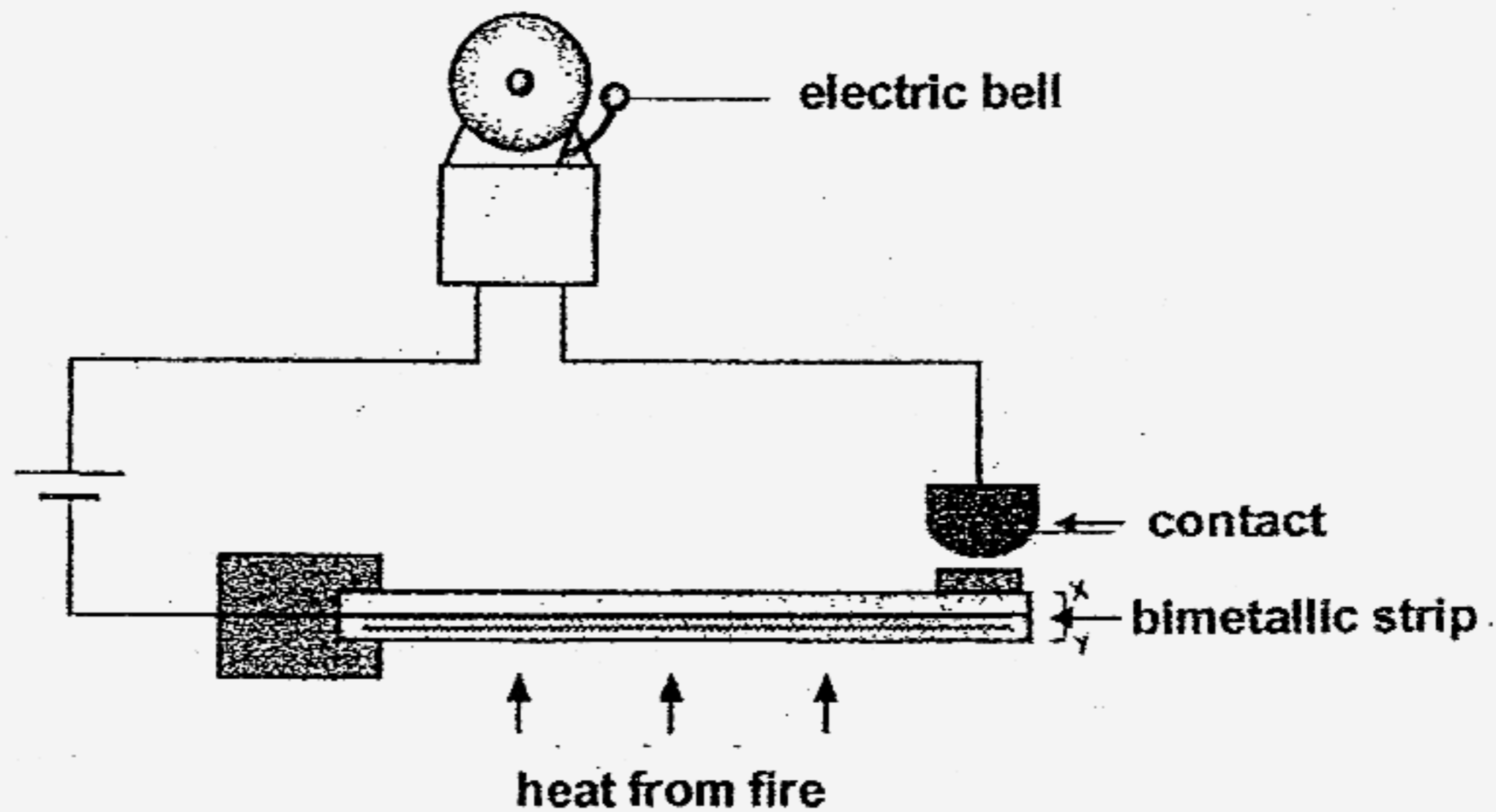

Explain how the fire alarm is activated by the heat from the fire. (2 m)

Step 1: The bimetallic strip gets heated up by the heat from the fire.

Step 2: _____

Step 3: _____

Step 4: The electric bell rings.

41. Beaker A and beaker B contain water at different temperatures.

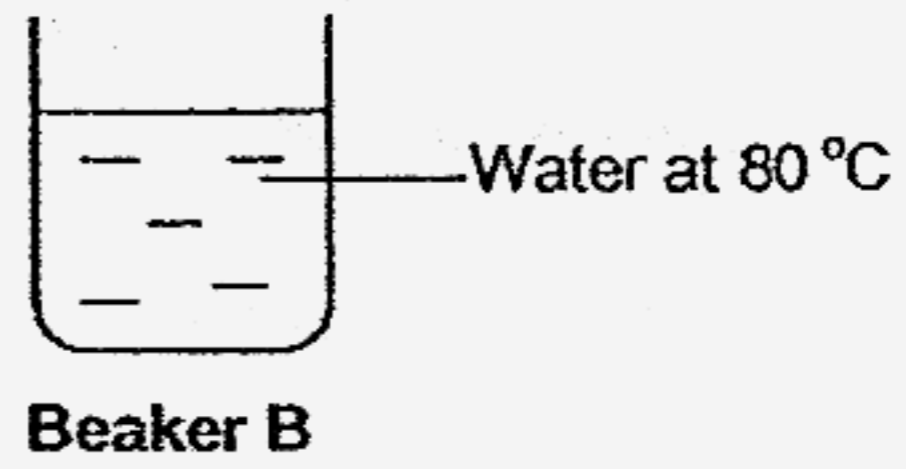
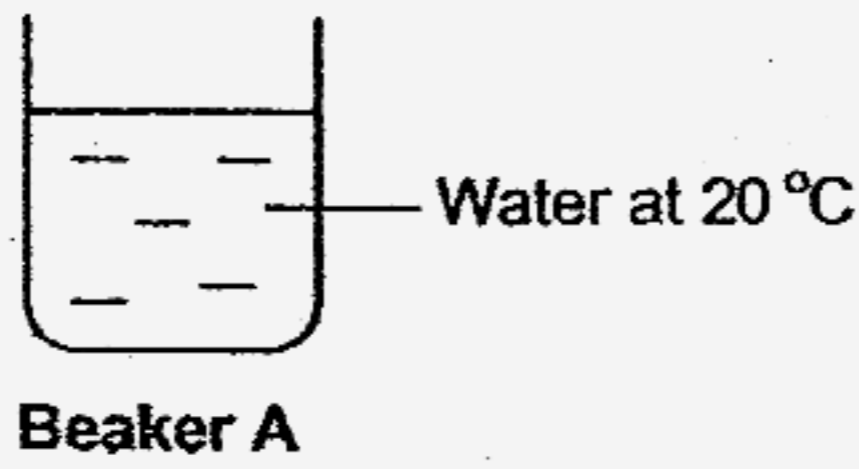

The two beakers of water were placed in a room temperature of 40°C. The water in beaker B reached the same temperature as the water in beaker A after 20 minutes.

Draw two lines in the grid provided to show how the temperatures of the two beakers of water change with time. (2m)

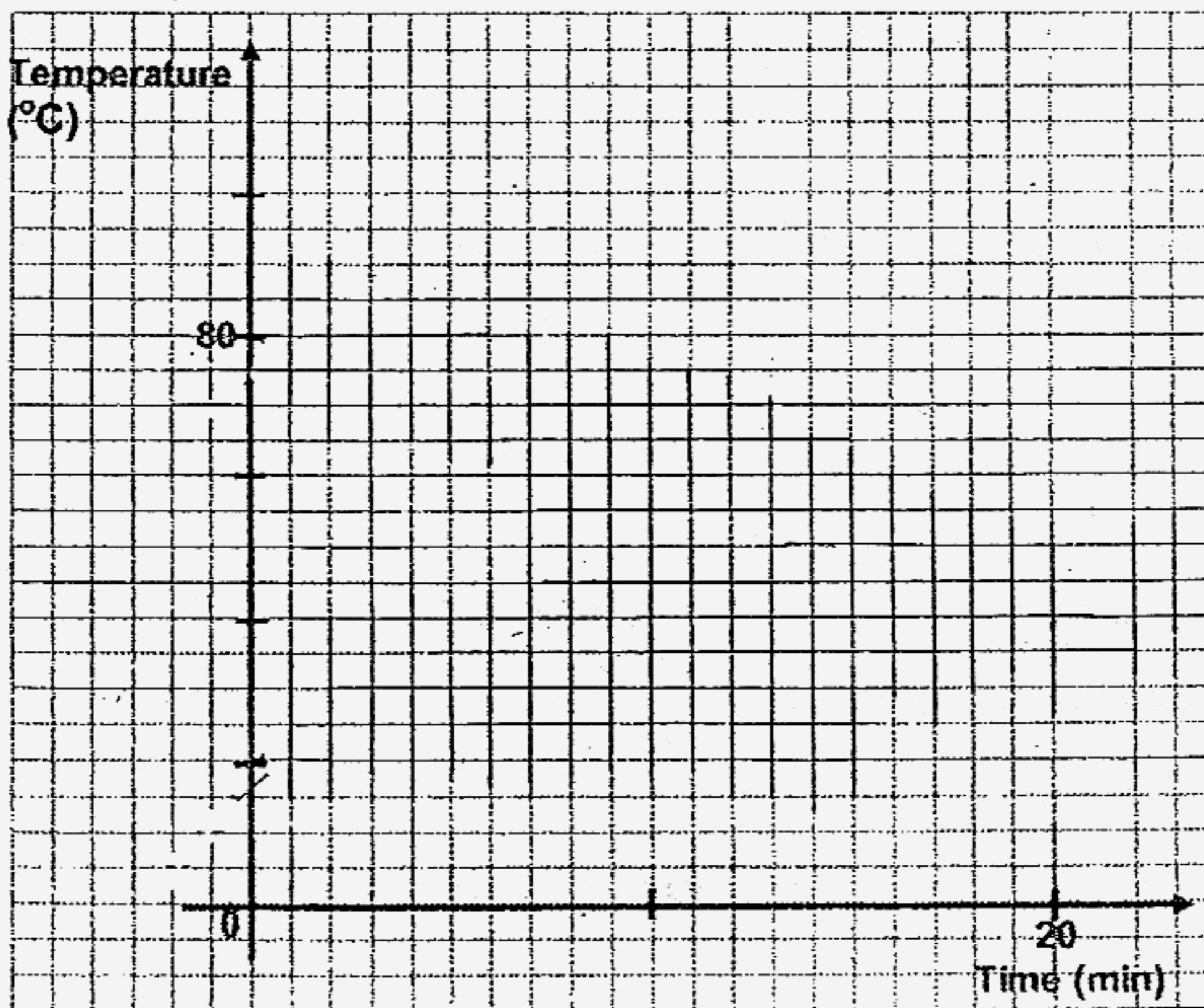

42. Tom conducted an experiment to find out if the magnetic strength of a bar magnet increases with its size. He hung all the four magnets at the same distance away from a tray of evenly spread nails.

The result of his experiment is shown below.

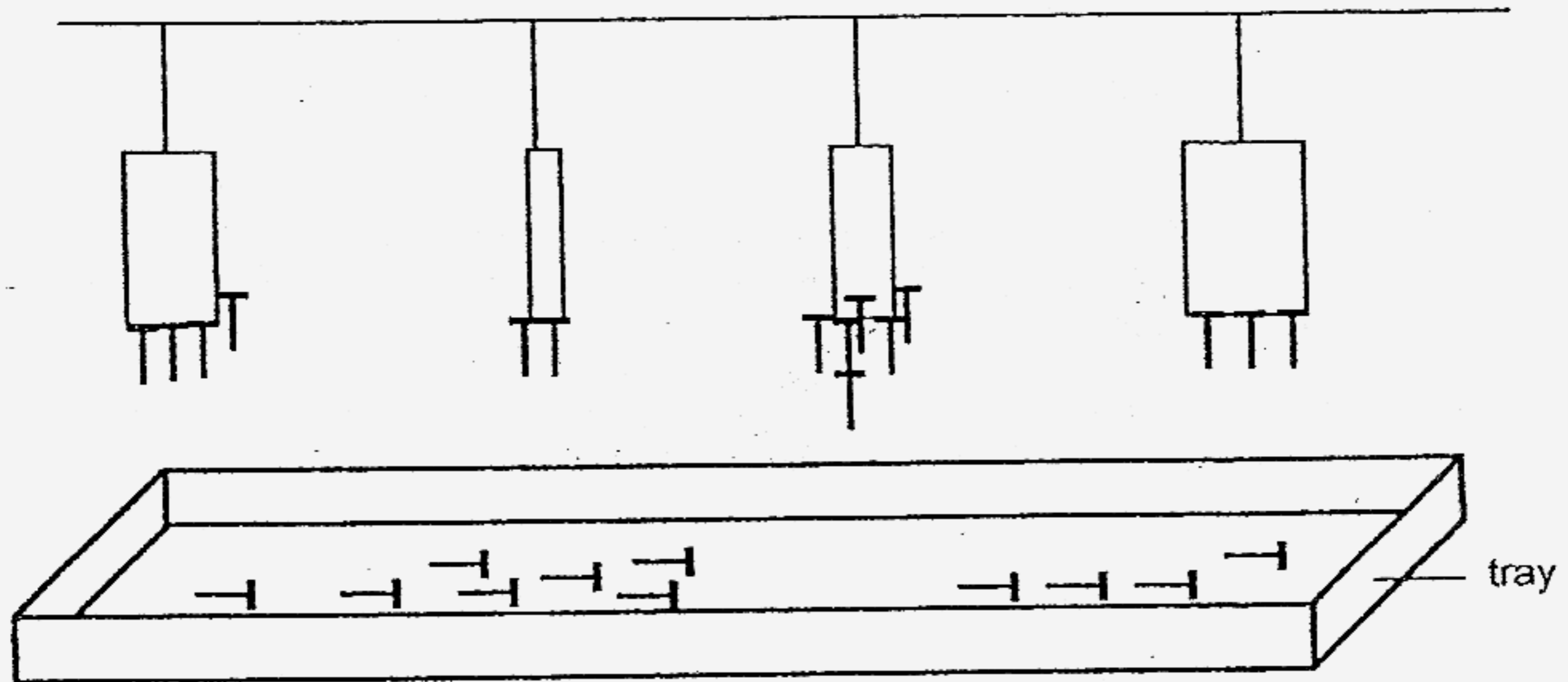

(a) What conclusion can Tom draw based on his result? (1 m)

(b) Based on Tom's experiment, which of the following statements are true? (1m)

(Indicate the true statements with a letter "T" in the boxes provided)

- i) Magnetic force can act at a distance.
- ii) Magnetism can pass through non-magnetic material.
- iii) The nails are made of magnetic materials

43. Weights were hung progressively to two springs P and Q to determine their degree of elasticity. The table below shows the result of the experiment.

Weights attached (g)	Length of spring P	Length of spring Q
0	?	8
20	9	10
40	12	12
60	15	14

(a) What is the original length of spring P? (1/2m)

(b) Which spring is more elastic? How do you know? (1m)

(c) What is the length of spring Q when a 50g weight is hung on it? (1/2m)

44. An empty glass with a piece of tissue paper stuck to its inner surface was lowered into a basin of water vertically until it is fully submerged.

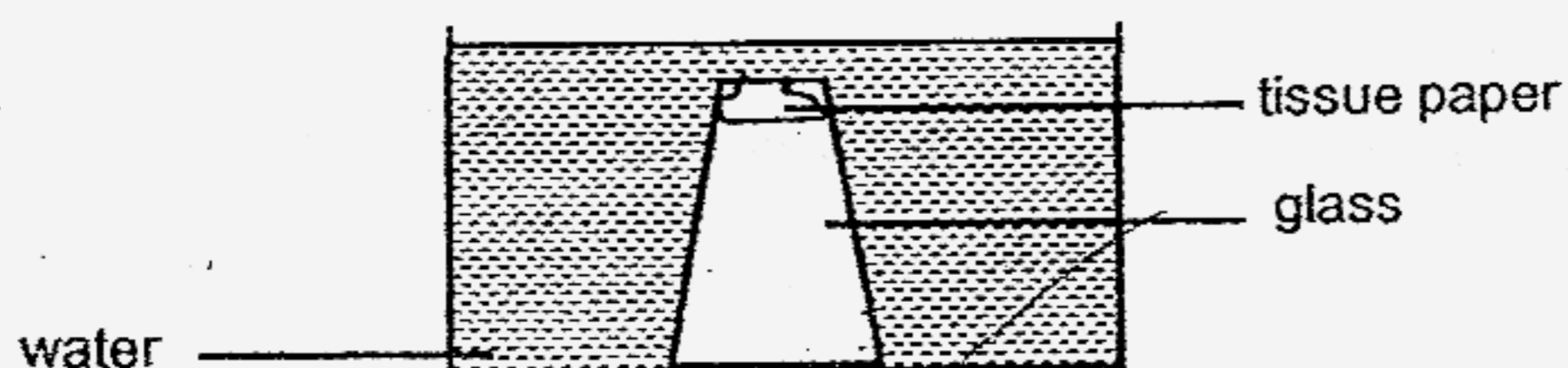

(a) Draw a line to show the level of water in the glass. (1m)

(b) Did the tissue paper get wet? Explain your answer. (1m)

45. Study the diagram below carefully. Two opaque blocks were used to cast a shadow on the screen.

(a) Show how you can determine the length of the shadow using dotted lines. (1m)

(b) Indicate the length of the shadow by drawing two crosses on the screen. (1m)

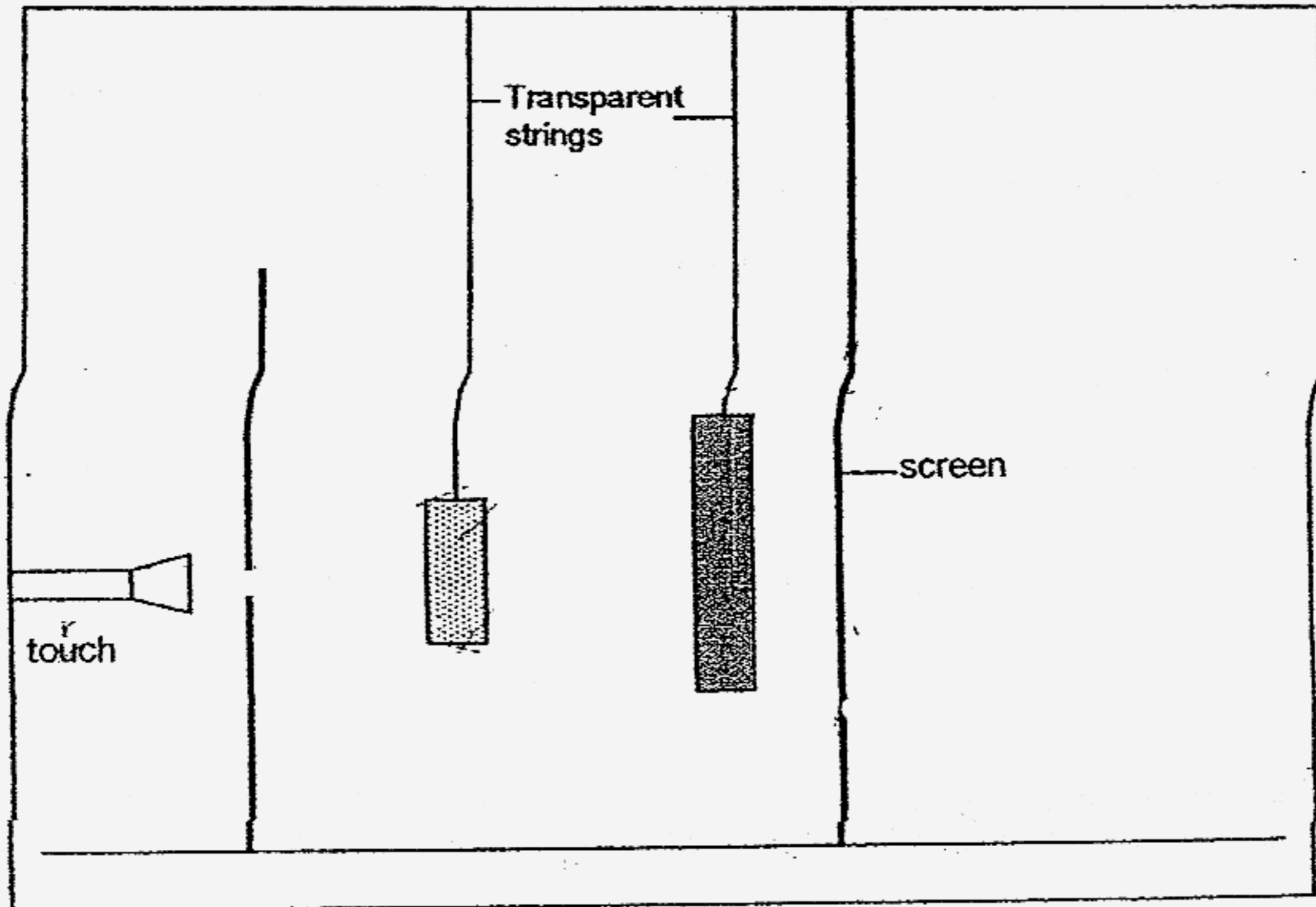

(b) What **property** of light causes the shadow to be formed? (1m)

46. Felix is given the following items to find out if the number of batteries in a circuit affects the brightness of the bulb.

- A bulb.
- Four batteries.
- Some wires

(a) Draw two circuit diagrams below to show how he would carry out the experiment. (2m)

Experimental set-up	Circuit diagram
1	
2	

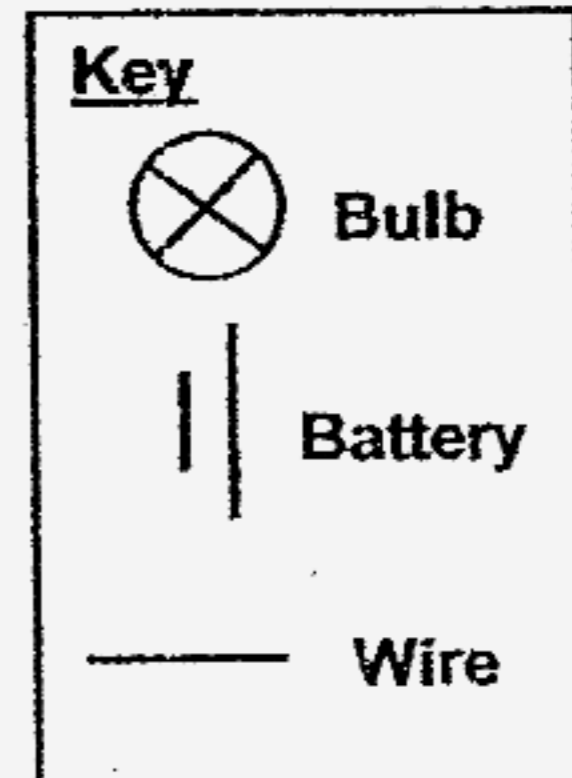

(b) What can you conclude from the two set-ups that you have drawn above? (1m)

~~~~~End of Paper~~~~~  
 Have you checked your answers?

**SECTION A : (60 MARKS)**

| Qn no. | Ans |
|--------|-----|
| 1      | 2   |
| 2      | 2   |
| 3      | 1   |
| 4      | 2   |
| 5      | 1   |
| 6      | 3   |
| 7      | 4   |
| 8      | 2   |
| 9      | 2   |
| 10     | 2   |

| Qn no. | Ans |
|--------|-----|
| 11     | 3   |
| 12     | 2   |
| 13     | 4   |
| 14     | 1   |
| 15     | 2   |
| 16     | 4   |
| 17     | 1   |
| 18     | 4   |
| 19     | 2   |
| 20     | 3   |

| Qn no. | Ans |
|--------|-----|
| 21     | 4   |
| 22     | 4   |
| 23     | 2   |
| 24     | 4   |
| 25     | 3   |
| 26     | 2   |
| 27     | 1   |
| 28     | 2   |
| 29     | 3   |
| 30     | 3   |



**SECTION B (40 MARKS)**

| Qn No. | Answers                                                                                                             |
|--------|---------------------------------------------------------------------------------------------------------------------|
| 31a    | The plastic bag is semi-permeable and only allows the iodine solution to enter but not the starch solution to exit. |
| 31b    | Cell membrane.                                                                                                      |

|         |                                        |
|---------|----------------------------------------|
| 32a     | A : Vertebrates      B : Invertebrates |
| 32b (i) | F                                      |
| (ii)    | D                                      |

|     |                                                                                                               |
|-----|---------------------------------------------------------------------------------------------------------------|
| 33a | Their seeds are dispersed by animals.                                                                         |
| 33b | Animals eat the fruits in group B and pass the seeds in the fruits in group A are left behind by the animals. |

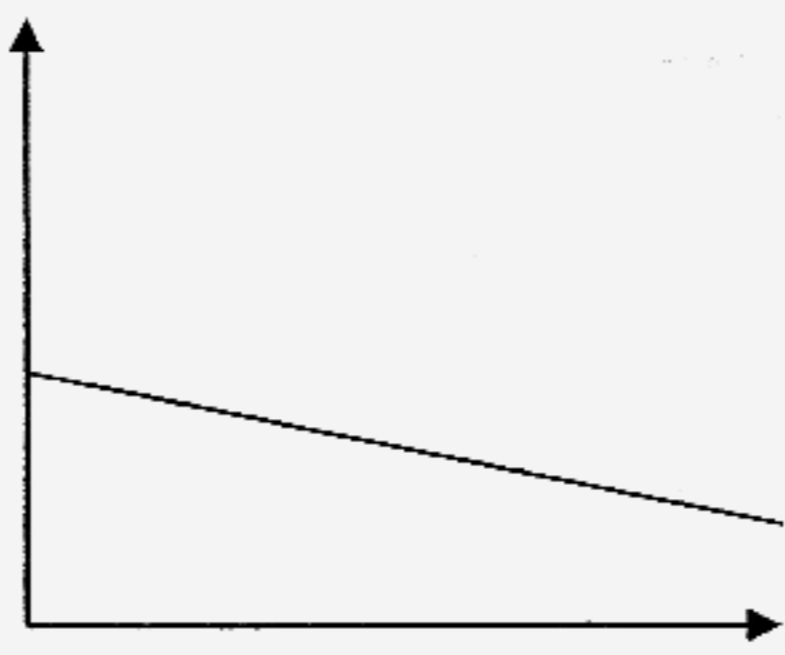
|     |                                                                                                                                                                                                                                                                |
|-----|----------------------------------------------------------------------------------------------------------------------------------------------------------------------------------------------------------------------------------------------------------------|
| 34a | The amount of soil used was different for each pot.                                                                                                                                                                                                            |
| 34b | I think the garden soil would be the best, it consists of equal amounts of sands and clay soil and therefore does not allow neither too much nor too little to pass through and it also contains decaying materials which will act as nutrients for the plant. |

| Qn No.  | Answers                                                                                                                                                                                                                                                             |
|---------|---------------------------------------------------------------------------------------------------------------------------------------------------------------------------------------------------------------------------------------------------------------------|
| 35a     | Glass tube : windpipe                      Balloons : Lungs                                                                                                                                                                                                         |
| 35b.    | The balloon would be inflated and then deflated.                                                                                                                                                                                                                    |
| 36a     | He is trying to find out if a decaying decomposing prawn produces carbon dioxide.                                                                                                                                                                                   |
| 36b     | Materials which are bio-degradable can be degraded and will disappear, not pollute the environment and also provide nutrients to the plants.                                                                                                                        |
| 37a.    | Light                                                                                                                                                                                                                                                               |
| 37b.    | With sunlight, the plant photosynthesis producing oxygen which the lizard and flies need to respire.                                                                                                                                                                |
| 37c.    | Plants produce oxygen which animals need to survive.                                                                                                                                                                                                                |
| 38 (i)  |                                                                                                                                                                                  |
| 38 (ii) | It will be wiped out, adapt to the new environment or move away.                                                                                                                                                                                                    |
| 39a.    | Acrobat A could jump from a greater height.                                                                                                                                                                                                                         |
| 39b.    | The amount of gravitational potential energy depends on the height and weight of an object since the height of acrobat B and C are the same, acrobat C is heavier than acrobat B and more gravitational potential energy can be converted into more kinetic energy. |
| 40a     |                                                                                                                                                                                  |
| 40b     | 2 : Y expands more than X and causes it to curve inwards and upwards.<br>3 : The metal touches the contact and it becomes a closed circuit.                                                                                                                         |

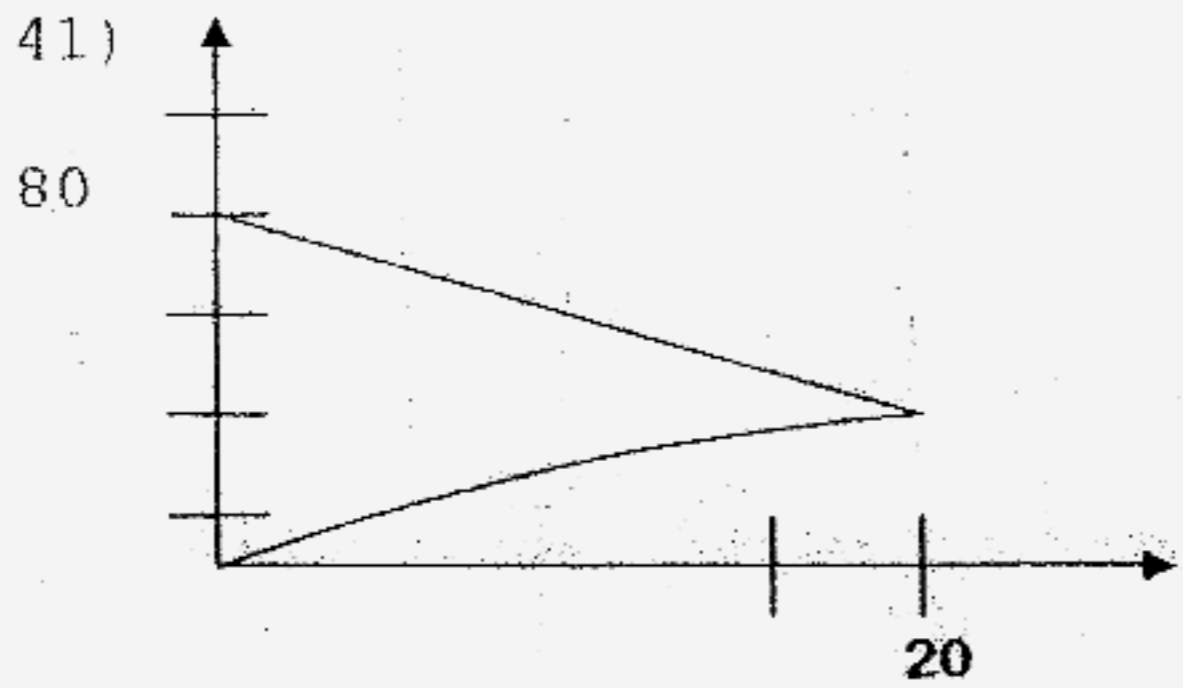
| Qn No. | Answers                                                                                       |
|--------|-----------------------------------------------------------------------------------------------|
| 41     | <p>41)</p>  |

|         |                                                                    |
|---------|--------------------------------------------------------------------|
| 42a     | The magnetic strength of a bar magnet does not depend on its size. |
| 42b (i) | True                                                               |
| (ii)    | -                                                                  |
| (iii)   | True                                                               |

|     |                                                                                                                                                                                              |
|-----|----------------------------------------------------------------------------------------------------------------------------------------------------------------------------------------------|
| 43a | 6cm                                                                                                                                                                                          |
| 43b | Spring P is more elastic. Each time a 20g load is attached on spring P, the length increases by 3cm. However each time a 20g load is attached on spring Q, the length increased by only 2cm. |
| 43c | 13cm                                                                                                                                                                                         |

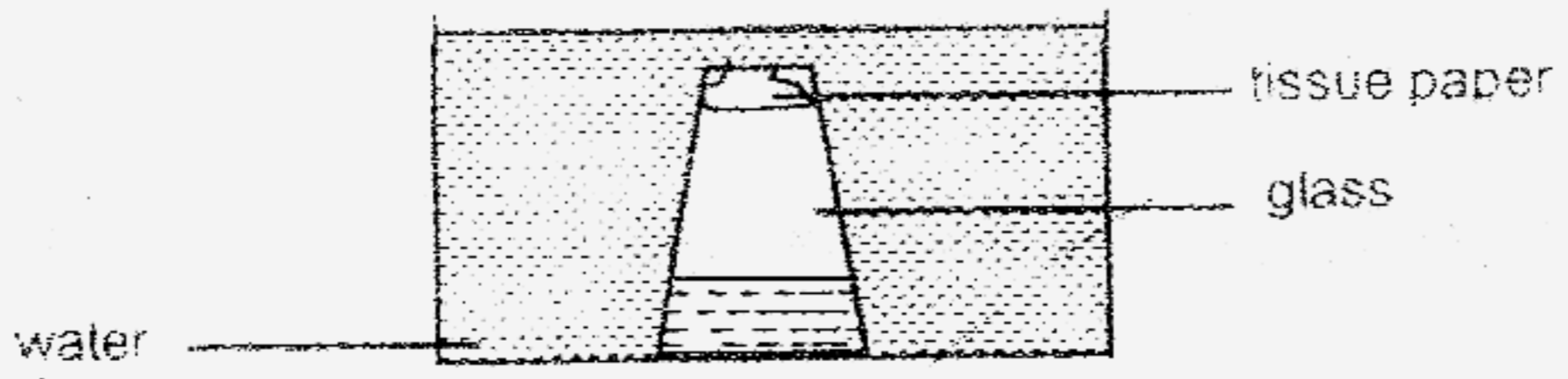
|     |                                                                                      |
|-----|--------------------------------------------------------------------------------------|
| 44a |  |
| 44b |                                                                                      |
| 44c | No, it did not. The glass contains air which prevents all the water from entering.   |

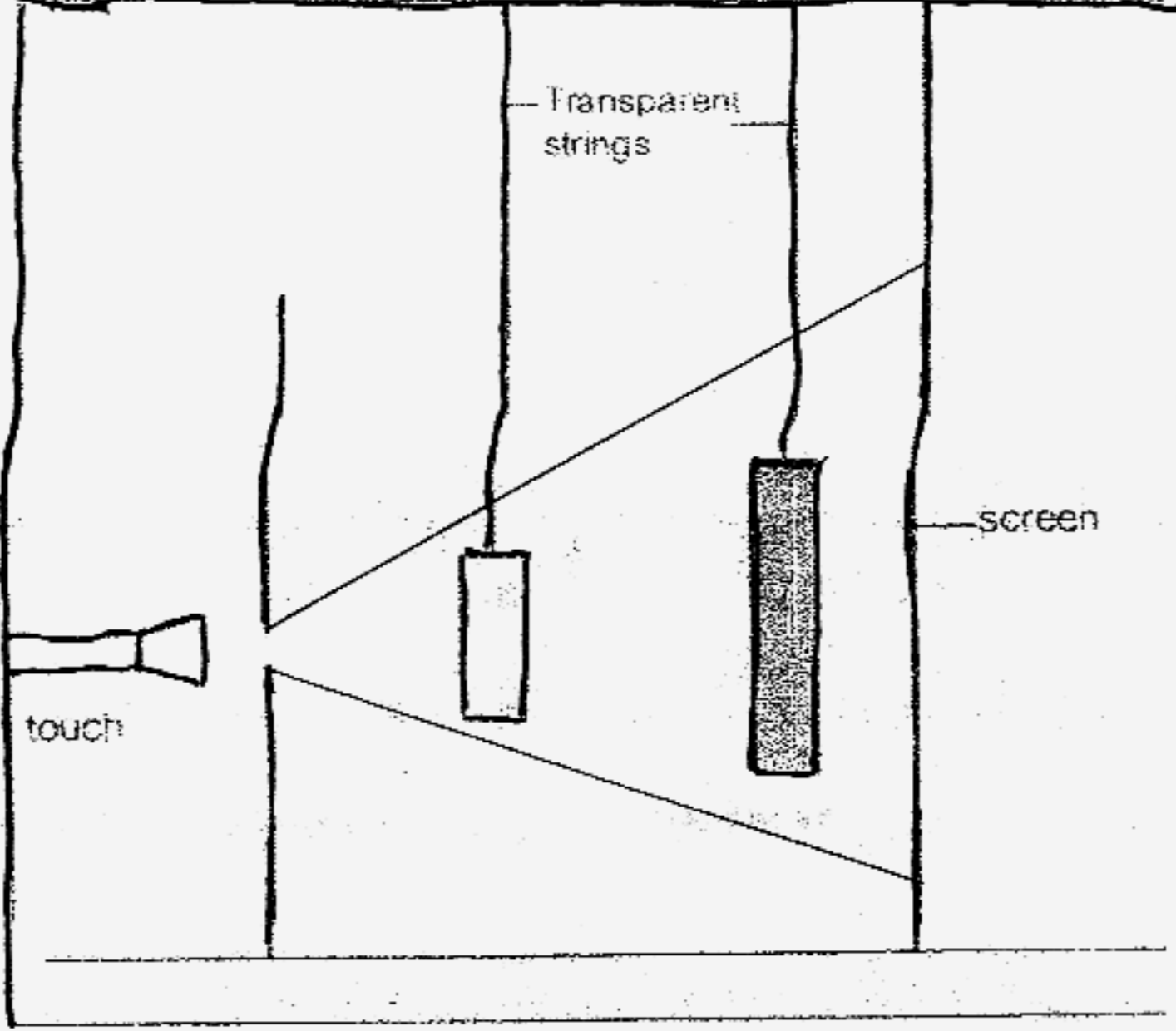

| Qn No. | Answers                                                                             |
|--------|-------------------------------------------------------------------------------------|
| 45a    |  |
| 45b    | <b>Light travels in a straight line.</b>                                            |

|     |                                                                                      |
|-----|--------------------------------------------------------------------------------------|
| 46a |  |
| 46b | <b>Set up 1 will light up brighter than set up 2 as it has less batteries.</b>       |