

CA1

Name : _____ ()

2 March 2005

Class : P 6 _____

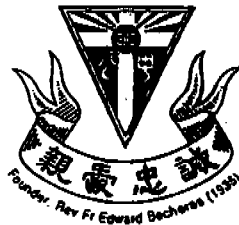

CATHOLIC HIGH SCHOOL
PRIMARY SIX
CONTINUAL ASSESSMENT 1
MATHEMATICS
BOOKLET A

15 questions

25 marks

Total Time For Booklets A and B : 2 h 15 min

INSTRUCTIONS TO CANDIDATES

Do not open this booklet until you are told to do so.

Follow all instructions carefully.

Answer all questions.

Questions 1 to 5 carry 1 mark each. Questions 6 to 15 carry 2 marks each.
For each question, four options are given. One of them is the correct answer.
Make your choice (1, 2, 3 or 4). Shade the correct oval on the Optical Answer Sheet.

1. In 876 305.42, the digit ____ is in the ten thousands place.

- (1) 6 (2) 7
(3) 3 (4) 8
-

2.

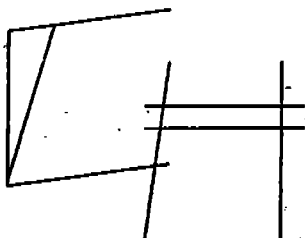

In the above diagram, there is/are _____ pair(s) of parallel lines.

- (1) 1 (2) 2
(3) 3 (4) 4
-

3. Find the edge of the cube if its volume is 64 cm^3 .



- (1) 2 cm (2) 4 cm
(3) 8 cm (4) 16 cm
-

4. Simplify $(7m + 5 - 2m) \div 3$.

- (1) $\frac{10}{3}m$ (2) $5m + 5 \div 3$
(3) $\frac{5m + 5}{3}$ (4) $\frac{9m + 5}{3}$
-

5. 3 oranges cost \$1.40. How much would 15 oranges cost?

- (1) \$1.40 (2) \$5.20
(3) \$7.00 (4) \$8.40
-

6. $\frac{2}{5}$ of Alan's marbles is equal to $\frac{1}{2}$ of Ben's marbles. What is the ratio of Ben's marbles to Alan's marbles?

- (1) 2 : 1 (2) 1 : 2
(3) 5 : 4 (4) 4 : 5
-

7.

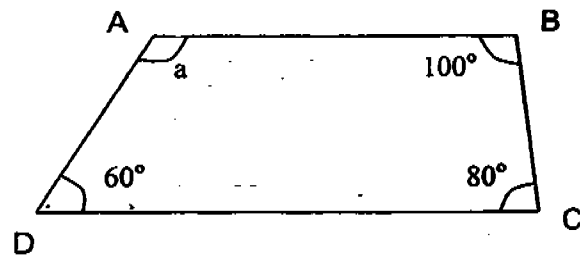

ABCD is a trapezium. Find $\angle a$.

- (1) 60° (2) 80°
(3) 100° (4) 120°
-

8. The solid is made up of 2-cm cubes. What is the volume of the solid?

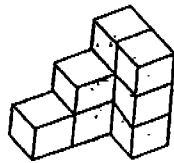

- (1) 7 cm^3 (2) 18 cm^3
(3) 56 cm^3 (4) 72 cm^3
-

9. There were 2 l of orange juice in a jug. Lynn poured it into 5 glasses each containing 230 ml. How much orange juice was left in the jug?

- (1) 850 ml (2) 1 000 ml
(3) 1 150 ml (4) 1 770 ml
-

10. A taxi driver charges \$2.20 for the first km and \$0.20 for every $\frac{1}{2}$ km or part thereof. How much will a passenger have to pay for a journey of $4\frac{1}{4}$ km?

- (1) \$1.80 (2) \$3.60
(3) \$3.80 (4) \$9.00
-

11. The figure is made up of 2 squares. Find the perimeter of the figure.

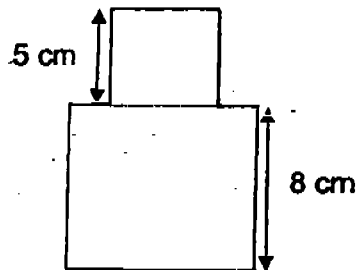

- (1) 39 cm (2) 42 cm
(3) 47 cm (4) 52 cm
-

12. Mrs Lim had $1\frac{3}{8}$ m of cloth. She gave $\frac{1}{2}$ m away to her neighbour and used $\frac{1}{2}$ of the remainder to sew a small bag. How much cloth had she left?

- (1) $\frac{3}{8}$ m (2) $\frac{7}{8}$ m
(3) $\frac{7}{16}$ m (4) $\frac{11}{32}$ m
-

13. A pencil box which was marked for \$12.50 was sold for \$10.00. What was the percentage discount?

- (1) 20% (2) 25%
(3) 75% (4) 80%
-

14. 10 children did a Science test. The average score was 61 marks. An eleventh child also took the test. The average score then became 58 marks. How many marks did the eleventh pupil get for the test?

- (1) 28 (2) 30
(3) 58 (4) 59.5
-

15. The table shows the number of story books each pupil in Pr 6Q read in Week 1. What was the total number of books read by Pr 6Q in that week?

No. of story books each pupil in Pr 6Q read	No. of pupils
0	5
1	11
2	13
3	7
4	3

- (1) 10 (2) 39
(3) 70 (4) 75
-

Name : _____ ()

2 March 2005

Class : P 6 _____



CATHOLIC HIGH SCHOOL
PRIMARY SIX
CONTINUAL ASSESSMENT 1
MATHEMATICS
BOOKLET B

35 questions

75 marks

Total Time For Booklets A and B : 2 h 15 min

INSTRUCTIONS TO CANDIDATES

Do not open this booklet until you are told to do so.

Follow all instructions carefully.

Answer all questions.

Marks obtained for Booklet A	25
Marks obtained for Booklet B	75
Total Marks	100

Questions 16 to 35 carry 1 mark each. Write your answers in the space provided.
Give your answers in the units stated.

Do not write
in this space

(Total: 20 marks)

16. A pair of shoes was sold for \$68 after a discount of 15%. What was the original price of the pair of shoes?

Answer : \$ _____

17. Mrs Tan spent $\frac{3}{8}$ of her money. She then saved $\frac{3}{4}$ of the remainder in the bank. What fraction of the money did she save?

Answer : _____

18.

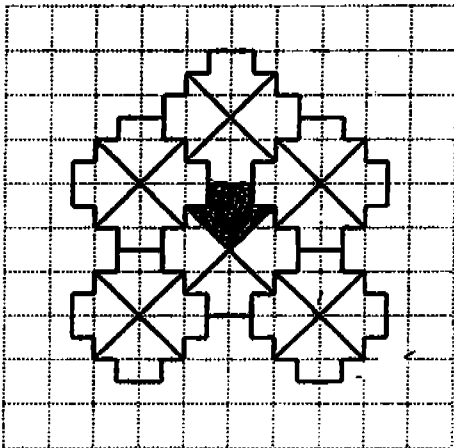

In the diagram above, shade the unit shape that is being tessellated.

19. Express 12 kg 85 g in kg. Give your answer as a decimal.

Answer: _____ kg

SCORE

20. Mr Tan deposited \$4500 into the bank. At the end of the year, he found out that the sum had increased to \$4590 due to interest. How much was the interest expressed in percentage?

Do not write
in this space

Answer: _____

21.

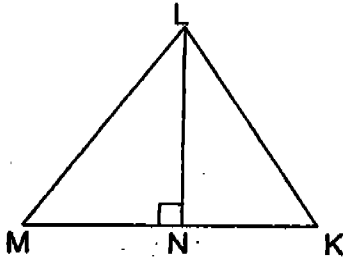

In the above diagram, KLM is an equilateral triangle. Find $\angle MLN$.

Answer: _____

22. Find the area of the shaded figure.

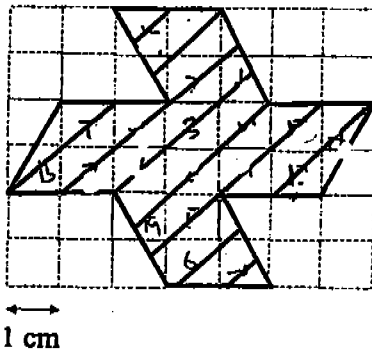

Answer: _____ cm^2

23. Find the value of $3c + \frac{3c}{5} - 8$ when $c = 15$.

Answer: _____

SCORE

24. Find $\angle a$ in the figure below.

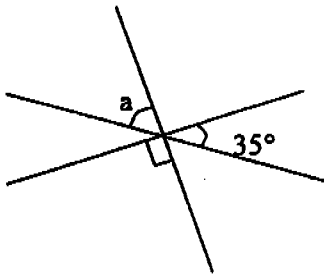

Answer: _____

Do not write
in this space

25. I am facing South. When I turn 225° clockwise, I will face the _____.

Answer: _____

26. Find the area of the rectangle.

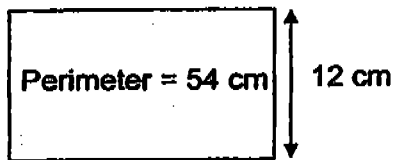

Answer: _____ cm^2

27.

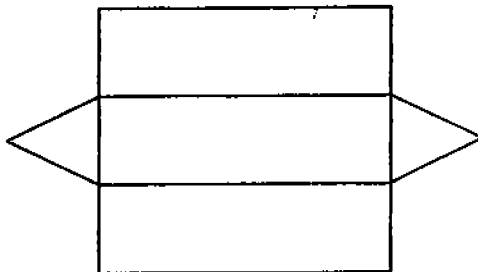

The above diagram shows the net of a solid. The solid is a _____.

Answer: _____

SCORE

28. Express 2h 15 min as a fraction of 4h in its simplest form.

Do not write
in this space

Answer : _____

29. What is the area of triangle ACD?

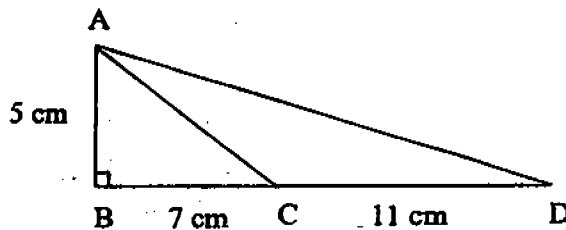

Answer : _____ cm^2

30. At 9.40 a.m., Keith reached the swimming pool. He spent 2 min to change. Then he started to swim. He got out of the pool at 10.18 a.m. How long did he swim?

Answer: _____ min

31. In a class of 44 pupils, there are 20% more boys than girls. How many girls are there in the class?

Answer : _____

32. Ian is 1.52 m tall. His sister is 9 cm shorter. What is his sister's height in metres?

Answer: _____ m

SCORE

The graph shows the height of a plant measured at 8 a.m. every day for 5 days. Study the graph and answer Questions 33 and 34.

Do not write in this space

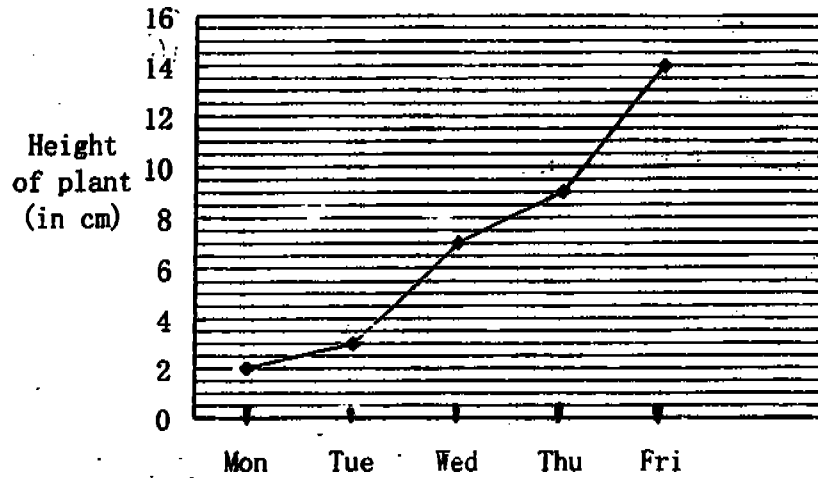

33. What was the increase in the height of the plant between Monday and Tuesday?

Answer: _____ cm

34. Between which 2 days did the plant grow the most?

Answer: _____ and _____

35. In the figure, the dotted line is the line of symmetry of the figure. Complete the figure.

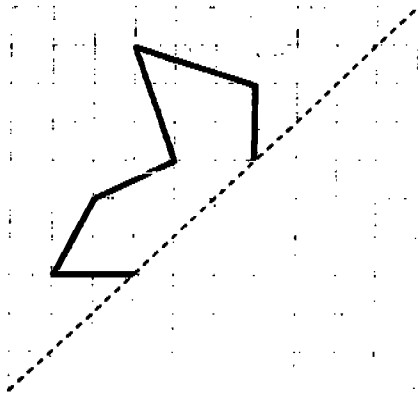

SCORE

For questions 36 to 50, show your working clearly in the space below each Question and write your answers in the spaces provided.

The number of marks available is shown in brackets [] at the end of each question or part-question.

(Total: 55 marks)

Do not write
in this space

36. The figure is made up of an equilateral triangle and a square. The area of the square is 36 cm^2 . Find the perimeter of the figure.

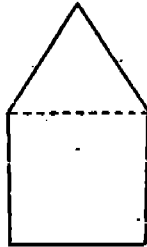

Answer: _____ [2]

37. A wheel turns at a rate of 9° per second. How many minutes will it take to turn one round?

Answer : _____ [2]

38. Henry is $5n$ years old. His father is thrice his age. How old will the father be when Henry is 29 years old? Express your answer in terms of n .

Answer : _____ [2]

SCORE

39a) In the space below, draw the parallelogram ABCD. The sides AB and BC have been drawn for you.

Do not write
in this space

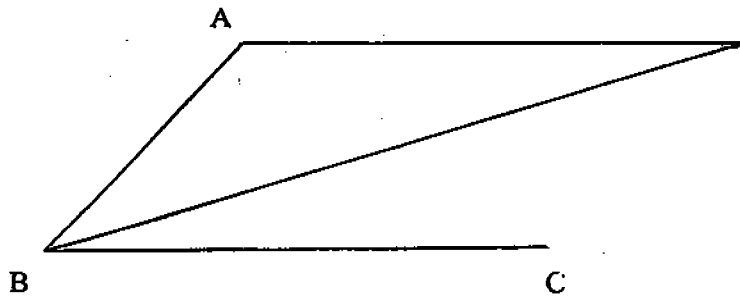

[2]

b) Join BD. Measure and write down the size of $\angle BDC$.

Answer : b) _____ [1]

40. Alex earned \$450 more than Benny. Alex saved $\frac{3}{4}$ of his salary while Benny saved $\frac{3}{7}$ of his. Both spent the rest of their money. Benny's expenditure was twice as much as Alex's expenditure. Find the salary of Alex.

Answer : _____ [3]

SCORE

41.

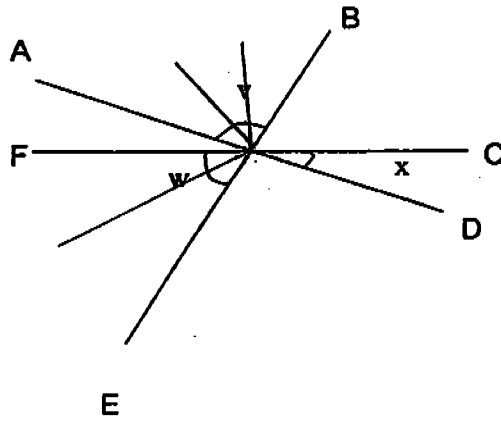

Do not write
in this space

AD, BE and FC are straight lines. $\angle w$ is twice of $\angle x$ and $\angle v$ is thrice of $\angle x$. Find $\angle y$.

Answer : _____ [3]

SCORE

42. The graph shows the results of a survey of the favourite food of the members of a club.

Do not write
in this space

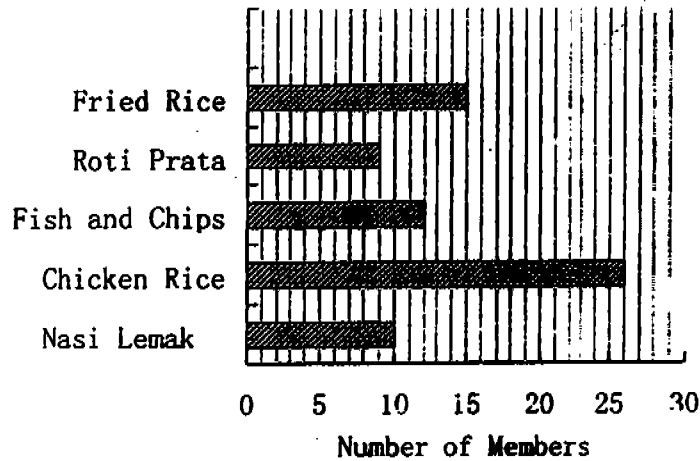

Study the graph. Then answer these questions:

- Which is the least popular food?
- How many more people prefer Chicken Rice to Fried Rice?
- What percentage of the members like Fish and Chips?

Answer: a) _____ [1]

b) _____ [1]

c) _____ [2]

SCORE

43. The ratio of the number of boys to the number of girls in school A is 3:2.
The ratio of the number of boys to the number of girls in school B is 2:3.
School B has twice as many pupils as school A.

- a) Find the ratio of the number of boys in school A to the number of girls in school B.
- b) After 48 girls leave school B to join school A, the ratio of the number of boys to the number of girls in school B becomes 2:1.
How many girls are there in school B now?

Do not write
in this space

Answer : a) _____ [2]

b) _____ [2]

SCORE

44. Square PQRS is made up of 4 triangles and 2 smaller squares.
- Find the area of the small triangle.
 - Find the total area of the square PQRS.

Do not write
in this space

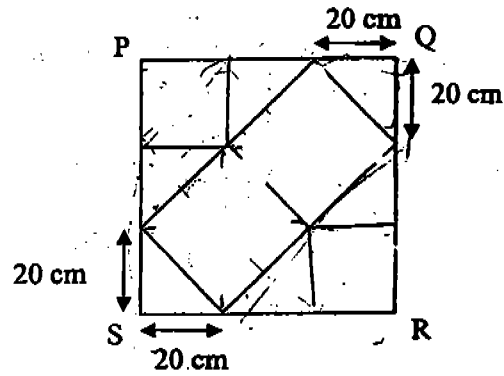

Answer : a) _____ [1]

b) _____ [3]

SCORE

45. Canoes are rented out at the rates shown in the table below.

Do not write
in this space

Time	Single canoe	Double canoe
1 st hour or part thereof	\$6.50	\$8.00
Every subsequent half hour or part thereof	\$2.00	\$3.50

Find the total cost of renting a single canoe and a double canoe from 10.50 a.m. to 2.45 p.m.

Answer : _____ [4]

SCORE

46. 0.6 of the workers in Alstro company are males while $\frac{1}{5}$ of the workers in Zerox company are males. There is an equal number of female workers in both companies. If Zerox company has 120 fewer workers than Alstro company, what is the total number of workers in both companies?

Do not write
in this space

Answer : _____ [4]

SCORE

47. An empty tank contains 4 solid cubes each of side 5 cm. The tank is then filled with water up to a height of 8 cm as shown below.

- a) Find the volume of water in the tank.
- b) If 2 of the cubes are removed without any loss of water, what is the height of the water level?

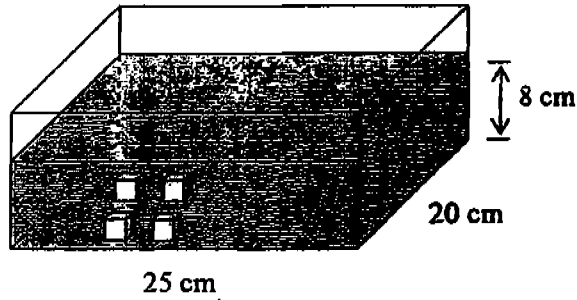

Do not write
in this space

Answer :a) _____ [3]

b) _____ [2]

SCORE

48. Look at the following figures and answer the questions.

Do not write
in this space

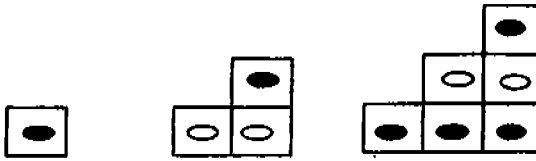

Figure 1

Figure 2

Figure 3

	Figure 1	Figure 2	Figure 3
Number of squares	1	3	6
Number of ●	1	1	4
Number of ○	0	2	2

- Find the number of ● in figure 5.
- Find the number of ○ in figure 6.
- Find the number of squares in figure 10.
- Which figure has 105 squares?

Answer : a) _____ [1]

b) _____ [1]

c) _____ [1]

d) _____ [2]

SCORE

49. Andrew spent \$840 of his salary on a VCD player and 25% of his remaining money on a washing machine. If he had 40% of his salary left, how much was his salary for the month?

Do not write
in this space

Answer : _____ [5]

SCORE

50. Daniel and Kester have some pens. If Daniel gives 10 of his pens to Kester, he will have twice as many pens as Kester. If Daniel gives 6 of his pens to him, he will have thrice as many pens as Kester. How many pens does Kester have?

Do not write
in this space

Answer : _____ [5]

SCORE

CATHOLIC HIGH SCHOOL (PRIMARY)
CONTINUAL ASSESSMENT 1
MATHEMATICS
PRIMARY SIX

CA1

- 1) 2
2) 3
3) 2
4) 3
5) 3
6) 4
7) 4
8) 4
9) 1
10) 2
11) 2
12) 3
13) 1
14) 1
15) 3
16) 80
17) 15/32
18)
19) 12.085
20) 2
21) 30
22) 20
23) 46
24) 55
25) North-East
26) 180
27)
28) 9/16
29) 27.5
30) 36
31) 20
32) 1.43
33) 1
34) Thu and Fri
35)
36) 30 cm
37) 2/3
38) 29 + 10 n
39) a) 30°
40) \$ 3600
41) 90°
42) a) Roti Prata
b) 11 people
c) 16 2/3%
43) a) 1 : 2 b) 24 girls
44) a) 200 cm² b) 3600 cm²
45) \$ 47.50
46) 360 workers
47) a) 3500 cm³ b) 75 cm
48) a) 9 b) 12 c) 55 d) Figure 14
49) \$ 1800
50) 6