

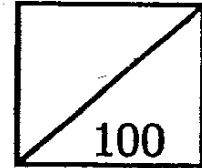

Rosyth School
First Semestral Assessment for 2007
SCIENCE
Primary 5



Total

Marks:

Name: _____

Class: Pr _____

Register No. _____

Duration: 1 h 45, min

Date: 14th May 2007

Parent's Signature: _____

Instructions to Pupils:

1. Do not open the booklets until you are told to do so.
2. Follow all instructions carefully.
3. This paper consists of 2 booklets, Booklet A and Booklet B.
4. For questions 1 to 30 in Booklet A, shade the correct ovals on the Optical Answer Sheet (OAS) provided using a 2B pencil.
5. For questions 31 to 46, give your answers in the spaces given in the Booklet B.

	Maximum	Marks Obtained
Booklet A	60 marks	
Booklet B	40 marks	
Total	100 marks	

* This booklet consists of 17 pages .

This paper is not to be reproduced in part or whole without the permission of the Principal.

14

Part I (60 MARKS)

For each question from 1 to 30, four options are given. One of them is the correct answer. Make your choice (1, 2, 3 or 4). Shade the correct oval (1, 2, 3 or 4) on the Optical Answer Sheet.

1. Why is Earth able to support life?

- A: Earth has just the right amount of sunlight for living things
- B: Earth has water in the correct state so that living things can thrive.
- C: Earth has an atmosphere to provide plants with carbon dioxide to make food.
- D: Earth has an atmosphere to keep the temperature just right for living things.

- (1) A and B only
- (3) C and D only

- (2) B and C only
- (4) A, B, C and D.

2. Study the diagrams carefully.



Diagram A



Diagram B

Diagram A shows Mary's drawing of the moon that she observed one night. After how long would she observe the phase of the moon as shown in Diagram B?

- (1) 7 days
- (3) 21 days

- (2) 14 days
- (4) 28 days

3. The table below shows the temperature of some planets in the Solar System.

Planet	Distance from the Sun (km)	Temperature (° C)
Mercury	58 million	430
Venus	108 million	400
Mars	228 million	20
Jupiter	778 million	- 140

What conclusion can you make from the table?

- (1) The size of the planet determines its temperature.
 - (2) The nearer the planet to the Sun, the lower its temperature.
 - (3) The further the planet from the Sun, the higher its temperature.
 - (4) The distance of the planet from the Sun determines its temperature.
4. Look at the table below.

Planet	Earth	Jupiter	Pluto
Distance from the Sun (million km)	150	778	5914
Time taken to make a revolution around the Sun	365 days	12 years	248 years

Which one of the following graphs represents the relationship between the distance the planet is from the Sun and the time taken for it to revolve around the Sun once?

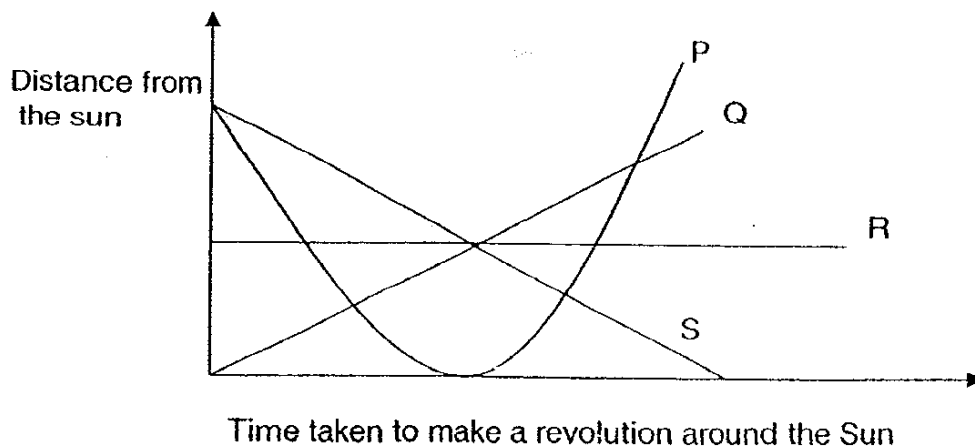

- (1) P
- (2) Q
- (3) R
- (4) S

16

5. Alex observed the cells taken from 2 different organisms under a microscope. He tabulated his observations as shown below.

Parts of cell	Cell A	Cell B
Cell wall	Present	Absent
Cell membrane	Present	Present
Nucleus	Present	Present
Cytoplasm	Present	Present
Chloroplast	Absent	Absent

From which organism are the cells taken?

	Cell A	Cell B
(1)	Animal	Animal
(2)	Animal	Plant
(3)	Plant	Animal
(4)	Plant	Plant

6. The diagram below shows how an amoeba divides itself.

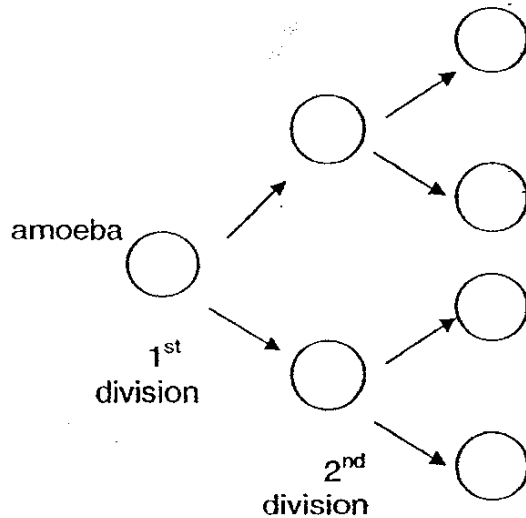

How many amoebae will be formed after five cell divisions?

- (1) 10
 (2) 16
 (3) 32
 (4) 64

7. If chloroplast could be successfully grafted into an animal cell, what do you think would happen?

- A: It would grow more quickly.
- B: It would have a regular shape.
- C: It would become green in colour.
- D: It would be able to photosynthesize.

- (1) A and B only
- (2) B and D only
- (3) C and D only
- (4) A, B, C and D

8. Which part of the plant cell is wrongly matched to its function?

	Part of a plant cell	Function
(1)	Nucleus	Controls all cellular activities
(2)	Cytoplasm	Allows cellular activities to take place
(3)	Chloroplast	Contains chlorophyll which traps light energy to make food
(4)	Cell membrane	Supports the cell and gives it a regular shape

9. Michael conducted an experiment to study the rate of respiration of yeast in a glucose solution. He recorded the results in the following table.

Time (minutes)	Number of Bubbles Produced
1	0
2	5
3	8
4	10
5	14

Which one of the following graphs should he use to plot the data above?

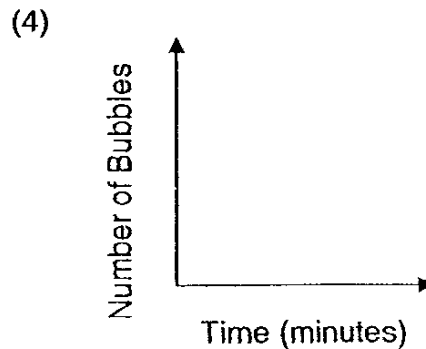
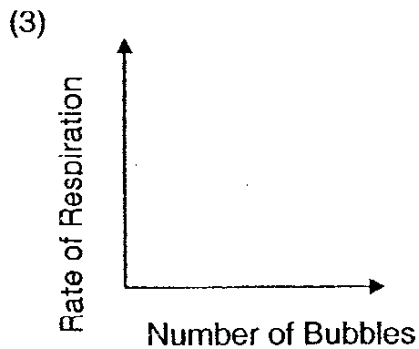
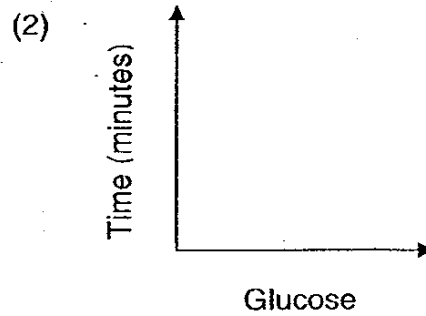
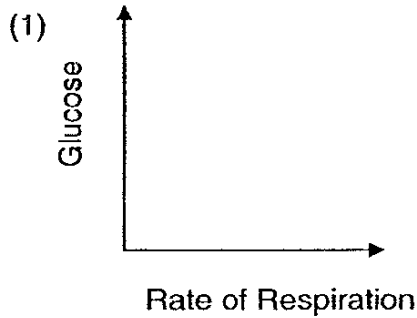

10. Bala placed an Elodea leaf on a slide and made an observation using the microscope.

The diagram below shows the observation.

Diagram 1

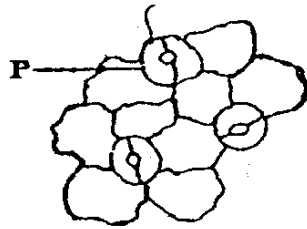

Next, Bala made a cross-section of the same Elodea leaf and made another observation.

The diagram below shows the observation.

Diagram 2

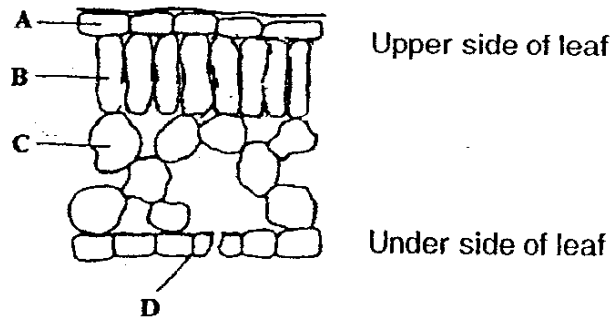

Which cell type in diagram 2 (A, B, C or D) is the same as cell P in diagram 1?

- (1) A (2) B
(3) C (4) D

11. The diagram below shows a concept map.

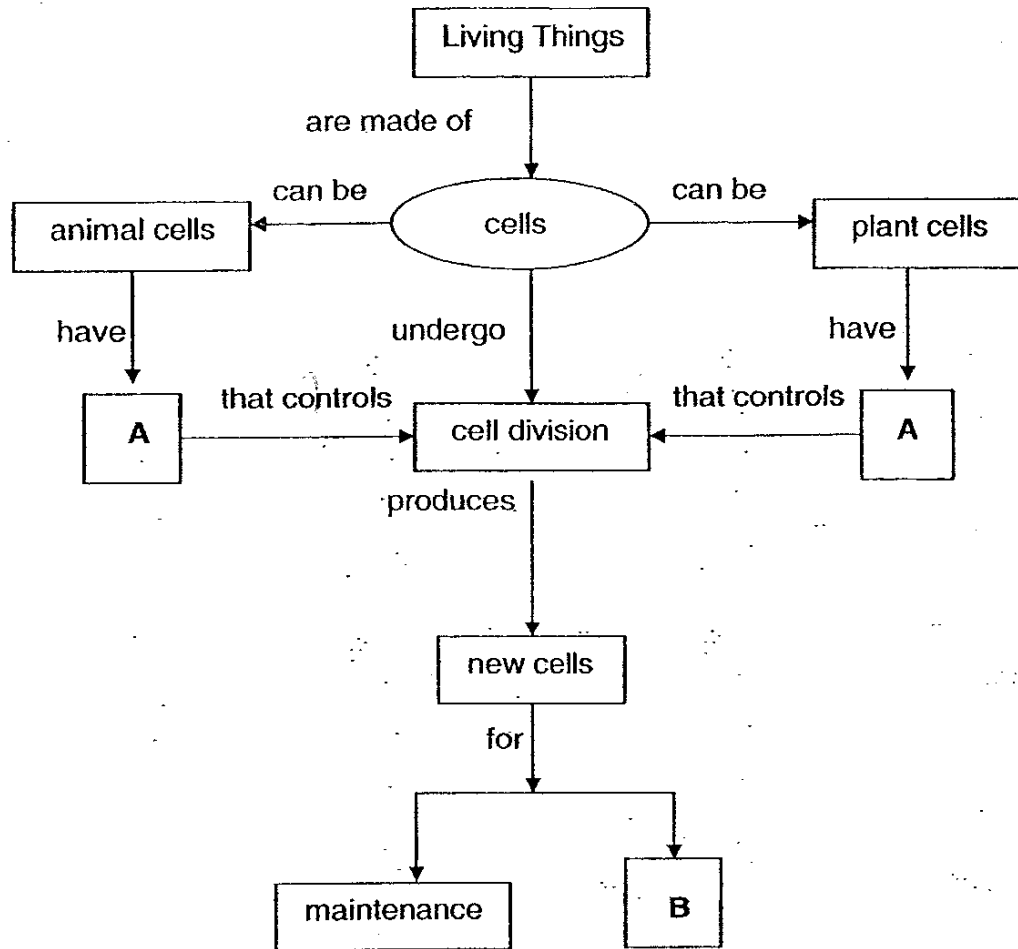

Which of the following best represents A and B?

	A	B
(1)	Cell wall	Reproduction
(2)	Nucleus	Growth
(3)	Chloroplast	Fertilization
(4)	Cytoplasm	Fusion of nuclei

21

12. The graph below shows the height of a pupil over a period of time.

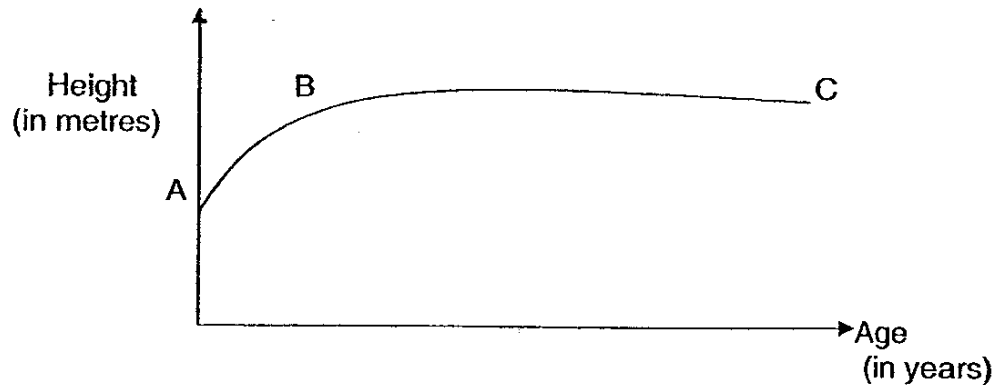

After studying the graph, each of them came out with their own deductions.

Ali: From B to C, there is no change in height because there is no cell division.

Philip: From A to B, there is an increase in height as the number of cells in the body increases.

Sarah: There is an increase in height from A to B as the size of the cells in the body grows bigger.

Who made the correct deduction(s)?

- (1) Ali only
- (2) Philip only
- (3) Ali and Philip only
- (4) Philip and Sarah only

22

13. Study the family tree shown below.

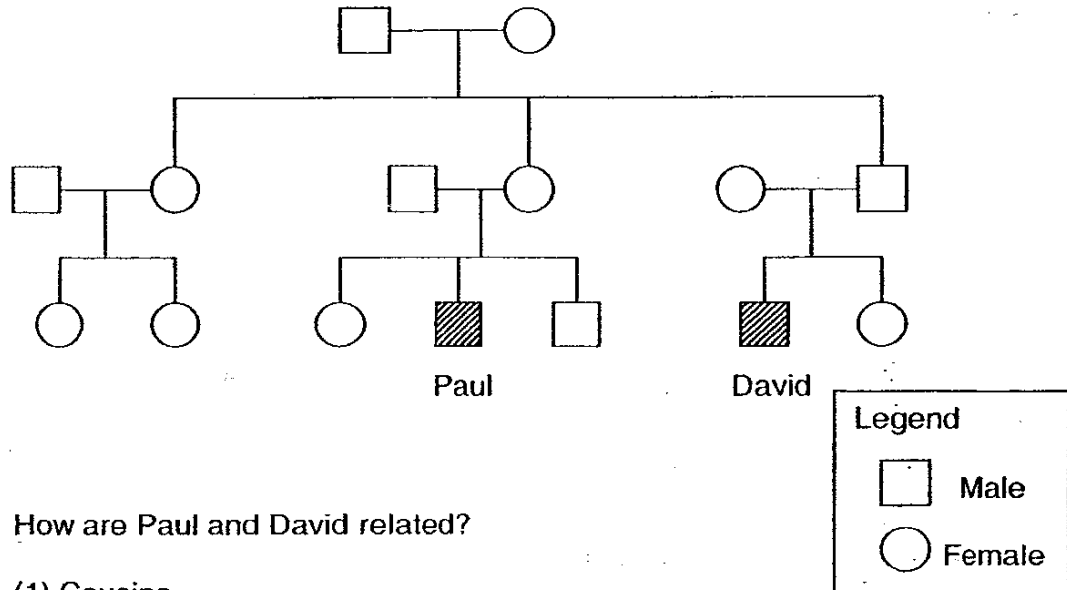

How are Paul and David related?

- (1) Cousins
- (2) Siblings
- (3) Father and son
- (4) Grandfather and grandson

14. The table below shows the physical characteristics of John and his parents.

	Physical Characteristics			
	Hair Length	Eyelids	Hair	Earlobes
John	Short	Single	Curly	Detached
Father	Short	Double	Curly	Attached
Mother	Long	Single	Straight	Attached

How many characteristics did John inherit from his parents?

- (i) He inherited one from each parent.
- (2) He inherited two from each parent.
- (3) He inherited one from his father and two from his mother.
- (4) He inherited two from his father and one from his mother.

23

15. Study the diagram below.

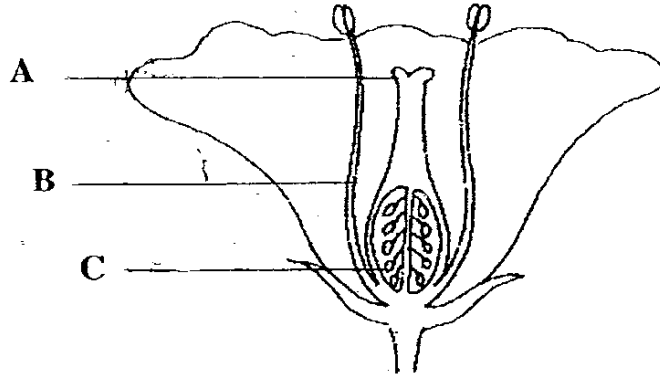

Identify the parts labelled A, B and C.

	A	B	C
(1)	Stamen	Ovary	Pollen Grain
(2)	Stigma	Style	Ovule
(3)	Stigma	Filament	Ovule
(4)	Anther	Style	Pollen Grain

16. Which one of the following shows the correct order of processes in a plant during reproduction?

- (1) Germination → Fertilisation → Seed dispersal → Pollination
- (2) Pollination → Fertilisation → Seed dispersal → Germination
- (3) Fertilisation → Seed dispersal → Pollination → Germination
- (4) Seed dispersal → Pollination → Germination → Fertilisation

17. Arvin observed that the flowers in his plant are visited by butterflies regularly.

Which of the following characteristics of the flowers could attract the butterflies?

- A: Sweet-smelling flowers
- B: Presence of nectar
- C: Presence of pollen grains
- D: Brightly coloured petals

- (1) A and B only
- (2) C and D only
- (3) A, B and C only
- (4) A, B and D only

24

Study the diagram below and answer questions 18 and 19.

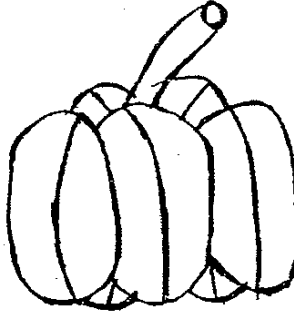

18. Kelly found the above fruit and made some observations. The observations are as follows:

It explodes open to scatter its seeds when it is ripe.
It is dry.

What is the most likely method in which the seeds of the fruit will be dispersed?

- (1) Wind
(2) Animals
(3) Water
(4) Splitting
19. In addition to the characteristics observed by Kelly, what other characteristics can the seeds have in order to be dispersed further?

A: Stiff hair
B: Hooks
C: Wing-like structure
D: Fine hairs

- (1) A only
(2) C only
(3) A and B only
(4) C and D only

20. Rachel picked a seed from her garden and kept it in a jar. The seed then germinated and grew into a seedling. After some time, she noticed some shrivelled parts of the seedling dropping off. What could these parts be?

- (1) Seed coat
(2) Seed leaves
(3) Shoots
(4) Roots

21. Sarah prepared two set-ups X and Y as shown below. She placed set-up X near the window and set-up Y in a cupboard. She observed the two set-ups over a period of time.

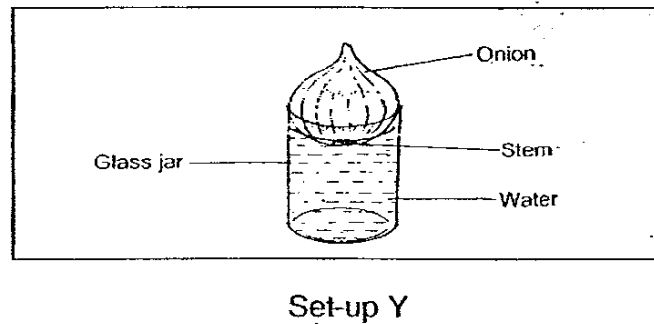
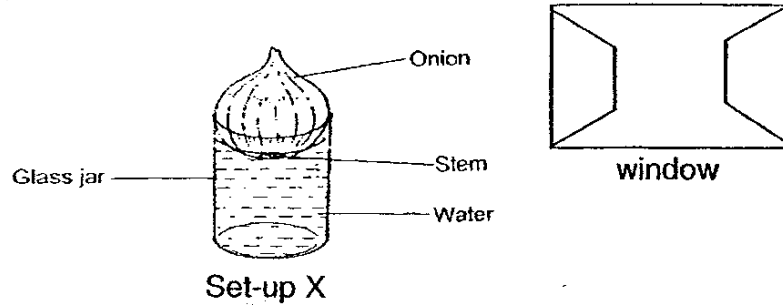

What is the aim of her experiment?

- (1) She wants to find out if warmth is needed for the onion to reproduce.
 - (2) She wants to find out if light is needed for the onion to reproduce.
 - (3) She wants to find out if water is needed for the onion to reproduce.
 - (4) She wants to find out if soil is needed for the onion to reproduce.
22. Mrs. Tang wants to grow a banana plant in her garden. Which one of the following actions should she do to grow the banana plant in a shorter time?
- (1) Plant the seeds in the banana fruit.
 - (2) Cut a sucker from an adult plant and plant it.
 - (3) Cut a portion of the leaves from an adult plant and plant it.
 - (4) Cut a portion of the roots from the old plant and plant it.

26

23. Which of the following is/are common to the spores of a bird's nest fern and the seeds of a lady's finger?

- A: Both are dispersed by water.
- B: Both are formed from the ovules of flowers.
- C: Both enable the reproduction of plants.

- (1) A only
- (2) C only
- (3) A and C only
- (4) B and C only

24. Below are some statements made by three children about reproduction.

Amy: Reproduction is a way to prevent the extinction of a species.
Brian: All living things need an egg and a sperm to reproduce.
Cindy: To ensure a higher chance of survival, all living things have more than one offspring at a time.

Who has/have made the correct statement(s)?

- (1) Amy only
- (2) Amy and Brian only
- (3) Cindy only
- (4) All of them

27

25. Study the diagrams below. They show the development of the human foetus over time.

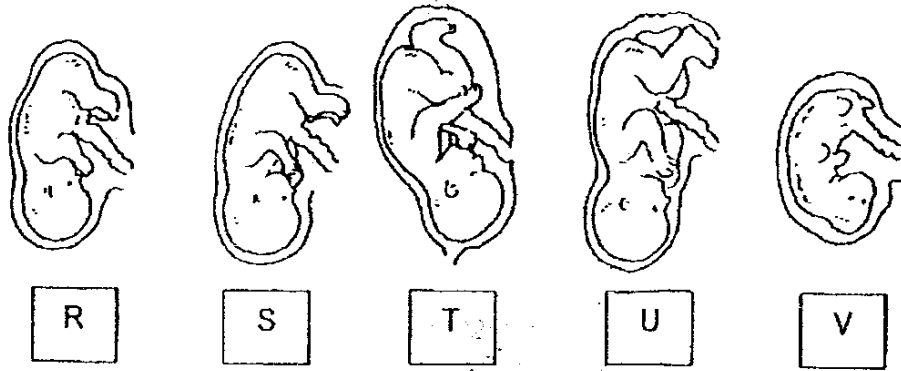

Which one of the following shows the correct order of the developing foetus?

- (1) S, U, V, R, T
- (2) R, V, U, S, T
- (3) V, R, S, T, U
- (4) V, R, S, U, T

28

A beaker containing some hydrilla plants was placed under the Sun as shown in the diagram below. Study the diagram and answer questions 26 and 27.

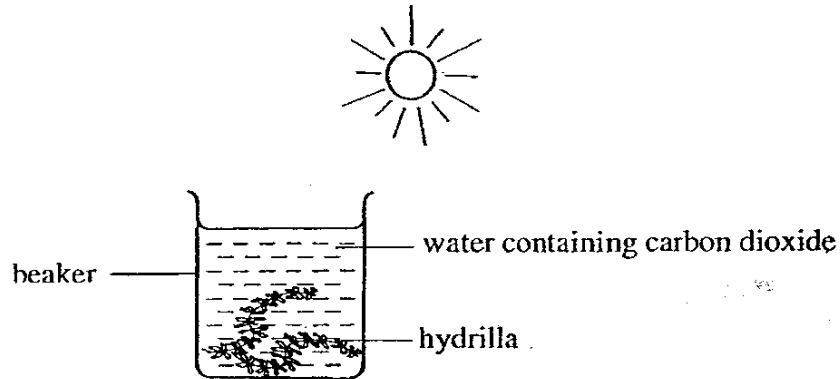

26. Four pupils observed some bubbles forming on the hydrilla plants. They made some inferences as follows:

- A: The hydrilla plants have photosynthesized.
- B: The bubbles contain oxygen that are produced when the plants photosynthesize.
- C: The bubbles are carbon dioxide that are produced when the plants respire.

Which inferences are correct?

- (1) A and B only
 - (2) A and C only
 - (3) B and C only
 - (4) A, B and C
27. Which one of the following lines in the graph correctly shows the changes in the amount of carbon dioxide in the beaker?

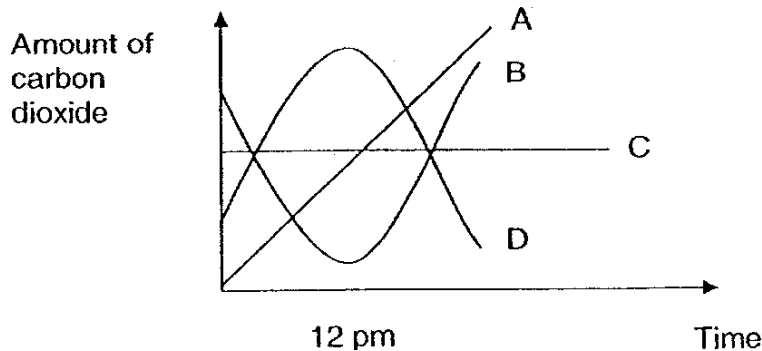

- (1) A only
- (2) B only
- (3) C only
- (4) D only

29

28. Alan is training for the school athletic competition. His teacher advised him to take big gulps of breath when he runs. What could be the reason?

- (1) This increases his rate of respiration so that more energy is produced.
- (2) This increases his rate of respiration so that more muscle-cells are formed.
- (3) This increases his rate of respiration so that carbon dioxide is converted into oxygen.
- (4) This increases his rate of respiration so that more glucose is produced for his body.

29. The graph below shows the amount of oxygen taken up and released by a green plant during a period of 24 hours. Study the graph carefully.

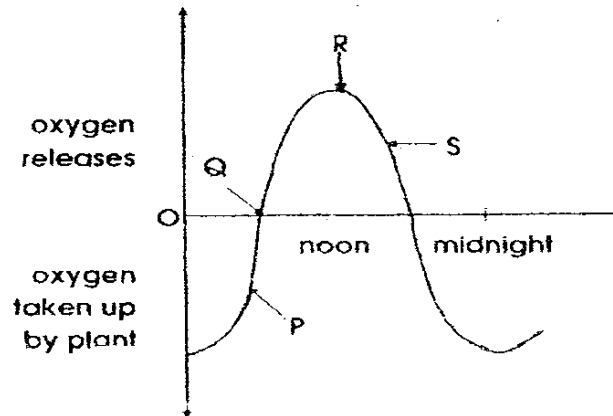

At which point is the rate of respiration equal to the rate of photosynthesis?

- (1) P
- (2) Q
- (3) R
- (4) S

30. Study the diagram below carefully

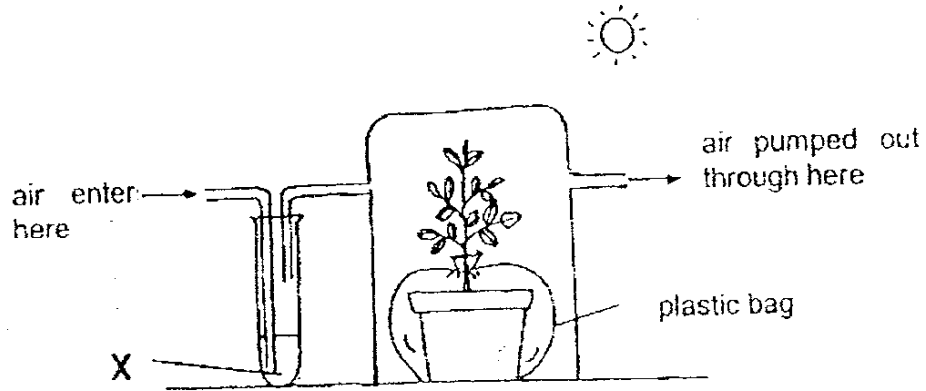

The plant was watered and left in strong sunlight for a few hours. Some leaves were then plucked and a starch test was done. None of the leaves contained starch. What could solution X contain?

- (1) It contained iodine.
- (2) It contained a liquid that absorbs oxygen.
- (3) It contained a liquid that absorbs carbon dioxide.
- (4) It contained a substance that absorbs water vapour.

End of Part 1

PART II (40 MARKS)

For questions 31 to 46, write your answers in this booklet.

31. Study the diagram below carefully.

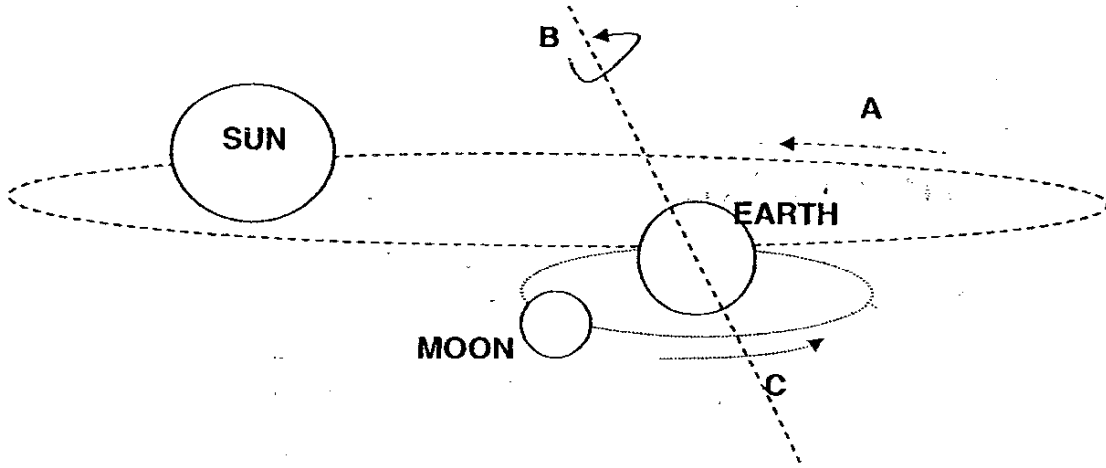

(a) State the type of movement represented by the arrows **A** and **B** and the time taken to complete each of the cycle respectively. (2 marks)

	Arrow	Type of movement	Time taken to complete one cycle
(i)	A		
(ii)	B		

(b) State one similarity between the Earth's movement and the Moon's movement as represented by arrows **A** and **C**. (1 mark)

32



Rosyth School
First Semestral Assessment for
SCIENCE
Primary 5

2007

Name: _____

Total
Marks:

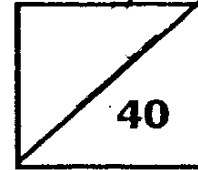

Class: Pr _____

Register No. _____

Duration: 1 h 45 min

Date: 14th May 2007

Parent's Signature: _____

Booklet B

Instructions to Pupils:

1. For questions 31 to 46, give your answers in the spaces given in this Booklet B.

* This booklet consists of 15 pages.

This paper is not to be reproduced in part or whole without the permission of the Principal.

32. The table below shows some information about planets E, F, G and H.

Planet	Average Temperature (°C)	Time to complete one revolution round the Sun
E	400	88 days
F	- 170	29 years
G	- 150	12 years
H	20	687 days

(a) Based on the information given, deduce the distance of the planets from the Sun. Arrange the planets (E, F, G and H) in the boxes provided below in increasing distance from the Sun. (1 mark)

--	--	--	--

Nearest to the Sun \longrightarrow Furthest from the Sun

(b) State the relationship between the distance the planet is from the Sun and its average temperature. (1 mark)

34

33. Study the classification table below.

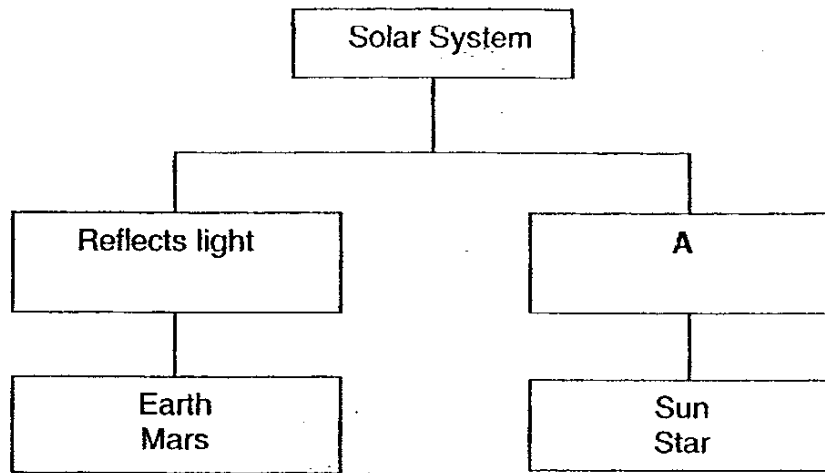

(a) Give an appropriate heading, identified by the letter A. (1 mark)

A: _____

(b) Under which heading would you place the Moon? (1 mark)

34. The diagram below shows four different positions of the Moon as it moves round the Earth.

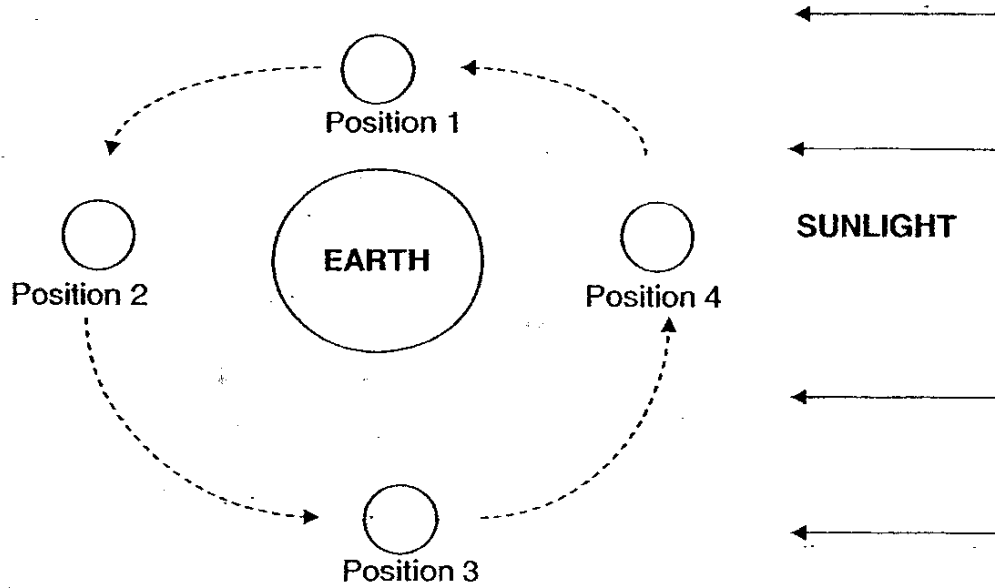

- (a) At which position (1, 2, 3 or 4) would you be able to observe a Full Moon? (1 mark)

- (b) Explain your answer in part (a). (1 mark)

36

35. Aziz wanted to find out if the presence of a cell wall controls substances from moving in and out of a plant cell. He conducted an investigation using substance P which is purple in colour. Two 400 ml beakers were also used.

Firstly, he set up beaker 1 using some plant cells as shown in the table below.

Beaker 1	Substance P	Tap water
	10 ml	300 ml

Secondly, he removed the cell walls of some plant cells to set up beaker 2.

- (a) Complete the table below to show how he should set up beaker 2. (1 mark)

Beaker 2	Substance P	Tap water

He observed that the plant cells in both beakers turned purple.

- (b) What conclusion could he make based on the observation? (1 mark)

36. John examined three cells under a microscope and recorded his observations in the table below.

Parts of a cell	Cell J	Cell K	Cell L
Nucleus	Present	Present	Present
Cell wall	Present	Absent	Present
Cytoplasm	Present	Present	Present
Chloroplast	Present	Absent	Absent
Cell membrane	Present	Present	Present

- (a) Which cell is likely to be taken from our cheeks? (1 mark)

- (b) Give a reason for your answer in (a). (1 mark)

38

37. Joshua and May got married and gave birth to three children. The diagram below shows the family tree of Joshua and May. The letter 'R' in the family tree indicates the members who are able to roll their tongues.

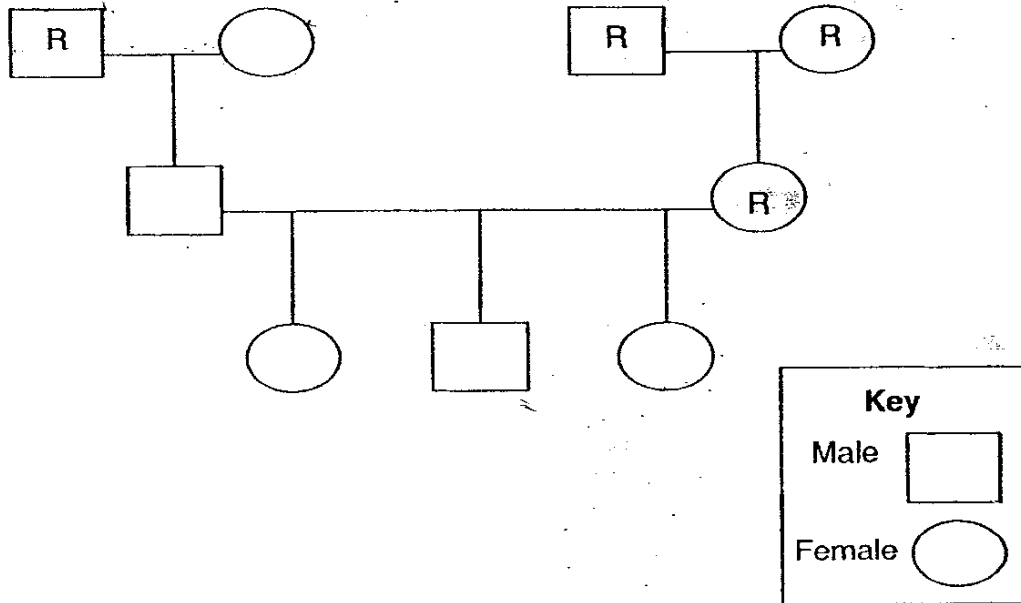

- (a) How many generations are represented in the family tree? (1 mark)

- (b) Based on the above family tree, complete the table given below by using a tick (✓) to indicate the member who is able to roll the tongue and a cross (X) to indicate the member who is not able to roll the tongue. (1 mark)

Members	Ability to roll tongue
Joshua's mother	
May's father	

- (c) Joshua and May's son married a girl who cannot roll her tongue.
 Do you think it is possible for them to have a child who is able to roll the tongue? (1 mark)

38. Issac has 2 unknown flowers, X and Y.

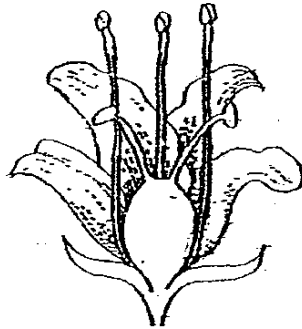

Flower X



Flower Y

(a) Identify how each flower is pollinated. (1 mark)

Flower X: _____

Flower Y: _____

(b) Describe the characteristics of each flower that determine how they are being pollinated. (1 mark)

39. Suzie was asked to give a description of the fruit and seeds below, based on its methods of dispersal.

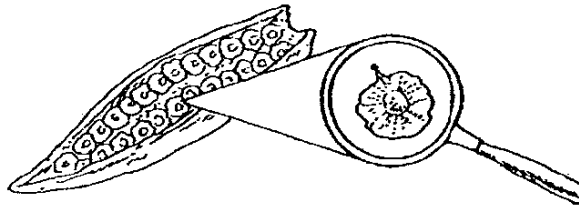

Her description is as follows:

It is dry and shoots its seeds away. It disperses its seeds by splitting action.

(a) What is the other method of dispersal that is missing from her description? (1 mark)

(b) Support your answer in part (a). (1 mark)

40

40. The graph below shows the mass of a seedling and its seed leaves over 8 days.

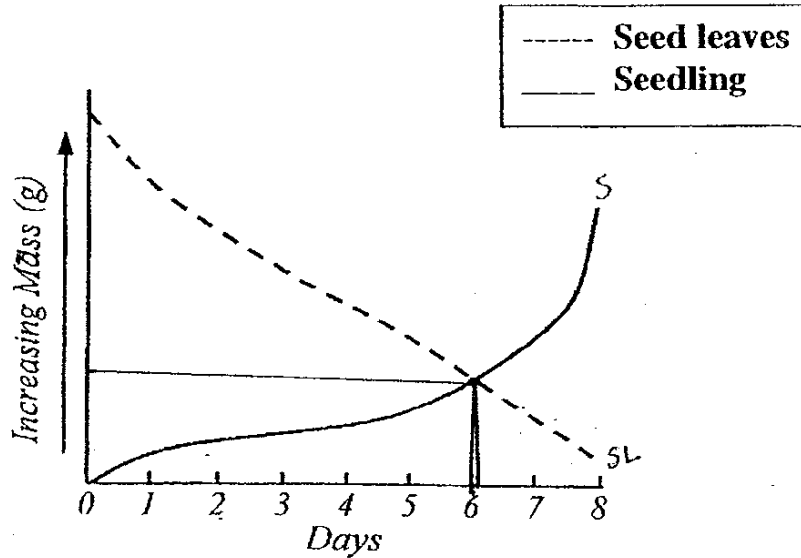

The graph shows that the mass of the seed leaves decreases as the mass of the seedling increases.
Explain why the mass of the seed leaves decreases while the mass of the seedling increases. (2 marks)

41(a) Rafie wanted to germinate some seeds in 4 containers. The table below shows the conditions each container is exposed to.

Container	Air	Temperature	Water
W	✓	35 °C	✓
X	x	35 °C	✓
Y	✓	5 °C	✓
Z	✓	35 °C	x

Rafie wanted to find out if the presence of air is needed in germination. To ensure a fair experiment, which 2 containers should he use? (1 mark)

(b) Rafie sets up another investigation as shown in the diagram below.

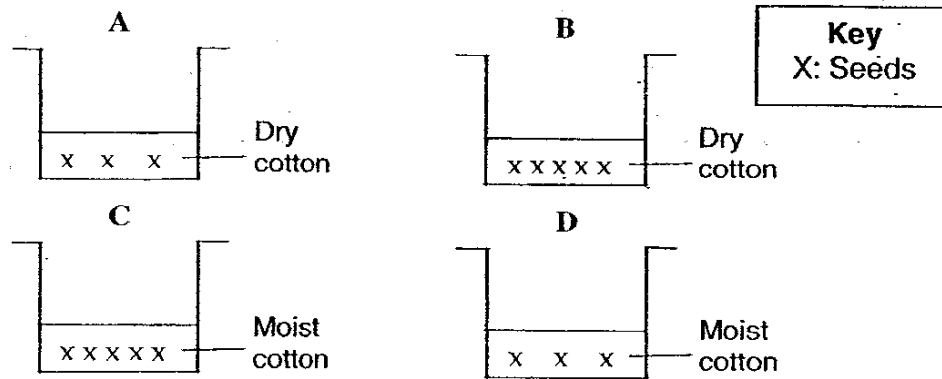

(i) Which of the two containers would the seeds germinate? (1 mark)

(ii) If the same experiment was conducted in a dark cupboard, would the results be the same? State the reason. (1 mark)

(iii) From your answer in part (b)(i), which container would the seedlings grow more healthily? (1 mark)

42. The diagrams below show female and male reproductive systems.

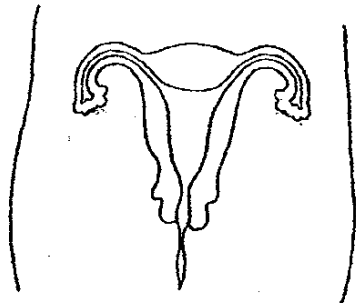

Diagram A

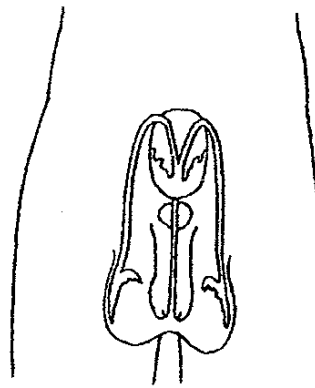

Diagram B

(a) Which part of the human reproductive system is missing in each of the diagrams, A and B above? (2 marks)

Diagram A: _____

Diagram B: _____

(b) Draw the missing parts of the female reproductive system in the diagram above. (1 mark)

43. The table below shows the average gestation period of 4 animals.

Animals	Average gestation period
Rat	21 days
Dog	9 weeks
Human	9 months
Elephant	22 months

(a) Based on the information above, what is the relationship between the animal size and the gestation period? (1 mark)

(b) How do male animals increase their chances of fertilising a female egg? (1 mark)

44

44. Carolyn wanted to find out if a plant could photosynthesise when its leaves are covered with oil. She used the following materials to conduct the investigation.

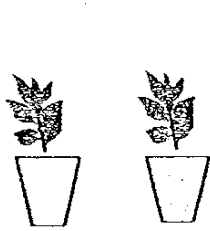

2 potted plants

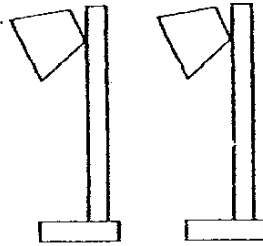

2 lamps



1 bottle of oil

- (a) The potted plants were given equal amount of water and had been kept away from the Sun for 3 days before she conducted her experiment. In the boxes below, draw how Carolyn could have set up her experiment. **Label the diagrams.** (2 marks)

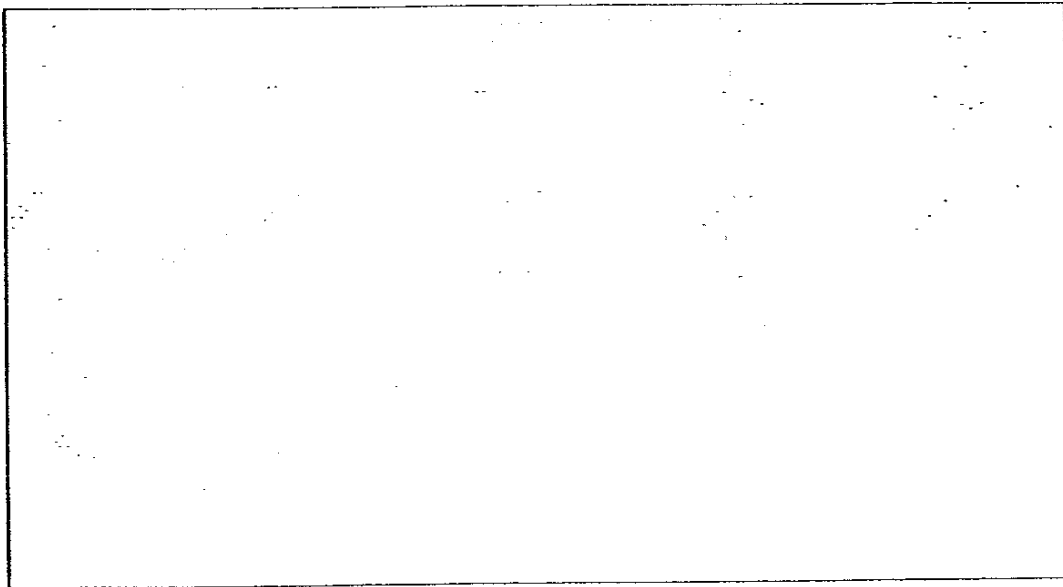

- (b) The experimental set up was left on a shelf for a week. Equal amount of water was given to the plants everyday. At the end of the week, what could she do to find out if the plants had photosynthesised? (1 mark)

45

45. The diagram below shows how a green leaf is tested for starch.

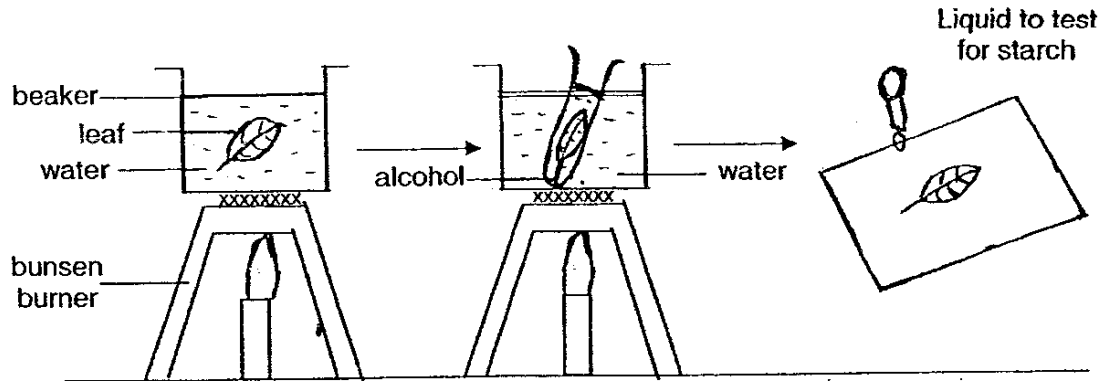

(a) Why must the leaf be placed in boiling water? (1 mark)

(b) What is the objective of placing the leaf in alcohol? (1 mark)

(c) What would you observe when you do a starch test? (1 mark)

46. The two beakers were placed near a window for a few days as shown below.

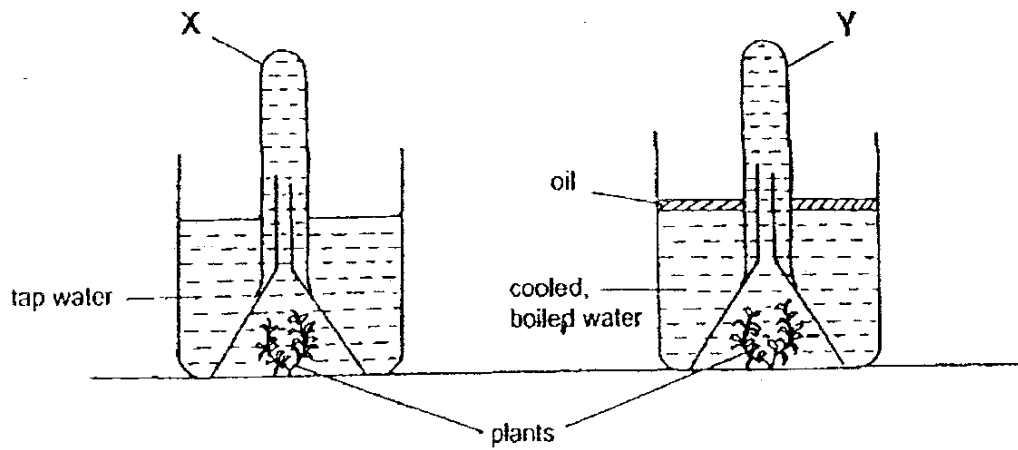

(a) Which test tube will contain oxygen after a few days? (1 mark)

(b) Explain how does boiling the water affect the plant's ability to make food? (1 mark)

(c) What is the purpose of the layer of oil in set-up Y? (1 mark)

END OF PAPER

Rosyth Primary School

Primary 5 Science SA1 Exams (2007)

Answer Keys

SECTION A : (60 MARKS)

Qn no.	Ans
1	4
2	2
3	4
4	2
5	3
6	3
7	3
8	4
9	4
10	4

Qn no.	Ans
11	2
12	2
13	1
14	1
15	3
16	2
17	4
18	4
19	4
20	2

Qn no.	Ans
21	2
22	2
23	2
24	1
25	4
26	1
27	2
28	1
29	2
30	3

SECTION B (40 MARKS)

31a.(i) Revolution ,365¼days

(ii) rotation, 24hours

31b. They moved in the same direction .they revolve pound an object in space.

32a. E,H,G,F

32b. The further a planet is from the sun , the lower it's average temperature is.

33a. Gives out light

33b. I will place the moon under the reflects light heading.

34a. At position 2, I would be able to full moon .

34b. At position 2, the side of the moon where it is totally brightened is facing the earth , thus I would be able to observe a full moon.

35a. 10ml, 300ml

35b. The presence of the cell wall does not effect what substance enters a plant cell./ does not control substances that move in and out of a plant cell .

36a. Cell K

36b. Cell K dose not have cell wall and chloroplast

37a. 3 generations are represented in the family tree.

37b. x , ✓

37c. Yes

- 38a. X : wind Y: Insect
38b. Flower X has long anther and stigma that are hanging out. Thus when the wind blows, pollen grains from the anther will fall on to the stigma. Flower Y has short anther and stigma, the wind is not able to blow the pollen grains away, so the insects collect pollens grains too.
- 39a. By wind
39b. It has wing-like structures to keep it a float for a longer time to reach a further distance it can grow.
40. As the seeding grow, it takes more food from the seed leaves ,thus it get heavier. The seed leaves grow lighter since the seeding is talking more of their stored food.
- 41a. He should use container Wand X.
41b.(i) Containers C and D .
(ii) Yes, the seeds only need air, water and warmth to germinate , so light is not needed .
(iii) container D there are lesser seeds in that container and will cause overcrowding

- 42a. A: Ovaries B: testes
42b.

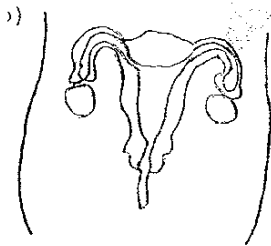

- 43a. The longer the gestation period , the larger the size of the animal is.
43b. They release more sperms into female reproductive system to fuse with the egg and fertilize it.

44a.

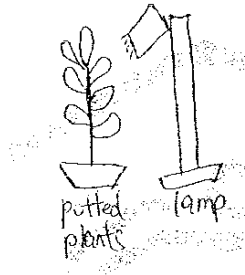

44b. She could pluck a leaf from each plant and dip it into alcohol then she must put a few drops of iodine on it. If the iodine turns blue, it shows the presence of starch, it means that the plant had photosynthesized if the iodine remains brown it means that the plant is not photosynthesized.

45a. It is to kill the leaves.

45b. To remove chlorophyll.

45c. The iodine turns dark blue.

46a. Test tube X

46b. It remove air which contain carbon from water that is needed for the plant to make food.

46c. It prevents the surrounding air from getting in the water.