

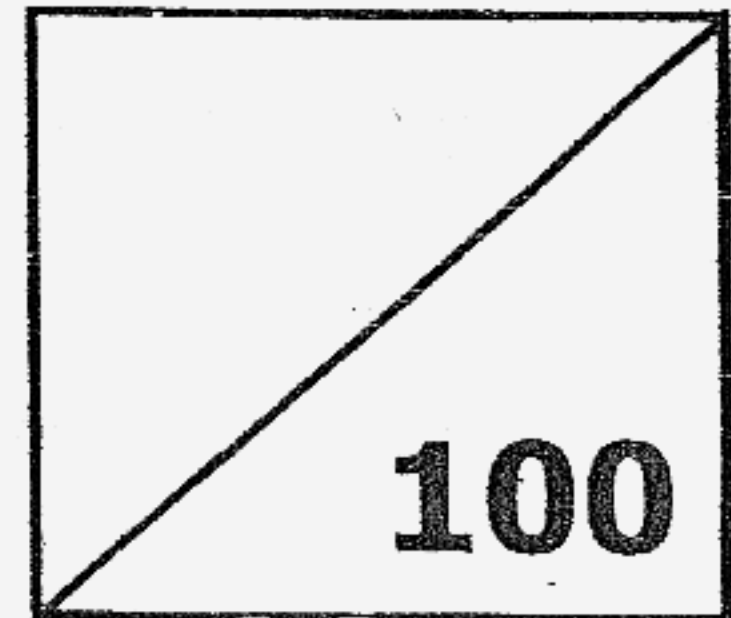

Rosyth School
 Second Semestral Assessment 2007
 Mathematics
 Primary 5



Name: _____

Class: Pr 5-_____ Register No. _____

Duration for Booklets A & B: **2 hours 15 min**

Date: 30 October 2007.

Parent's Signature: _____

BOOKLET A

Instructions to Pupils:

1. Do not open any booklet until you are told to do so.
2. Follow all instructions carefully.
3. This paper consists of 2 booklets.
 - Booklet A consists of Section A. Booklet B consists of Sections B and C.
4. For questions 1 to 15 in Section A, shade the correct ovals on the Optical Answer Sheet (OAS).
5. ANSWER ALL QUESTIONS.

	Maximum	Marks Obtained
Section A	20	

* Booklet A consists of **7** pages altogether.

This paper is not to be reproduced in part or whole without the permission of the Principal.

Section A

Question 1 to 15 carries 2 marks each. For each question, four options are given. One of them is the correct answer. Make your choice (1, 2, 3 and 4). Shade the correct answer on the OAS (Optical Answer Sheet). (20 marks)

1) Which one of the following has the digit 3 in the ten thousands place?

(1) 2 346 065

(2) 3 467 091

(3) 6 473 850

(4) 8 235 190

2) How many tens are there in 36 890?

(1) 36 890

(2) 3 689

(3) 368

(4) 36

3) $6\frac{3}{4} = 6 + \boxed{} + \frac{1}{12}$. What is the missing number in the box?

(1) $\frac{1}{4}$

(2) $\frac{1}{2}$

(3) $\frac{5}{6}$

(4) $\frac{2}{3}$

138

4) When a fraction is multiplied by 3, the answer is $\frac{3}{8}$. What is the fraction?

(1) $\frac{1}{24}$

(2) $\frac{1}{8}$

(3) $\frac{9}{8}$

(4) $\frac{27}{8}$

5) In the figure not drawn to scale, PR and ST are straight lines. Find $\angle UOT$.

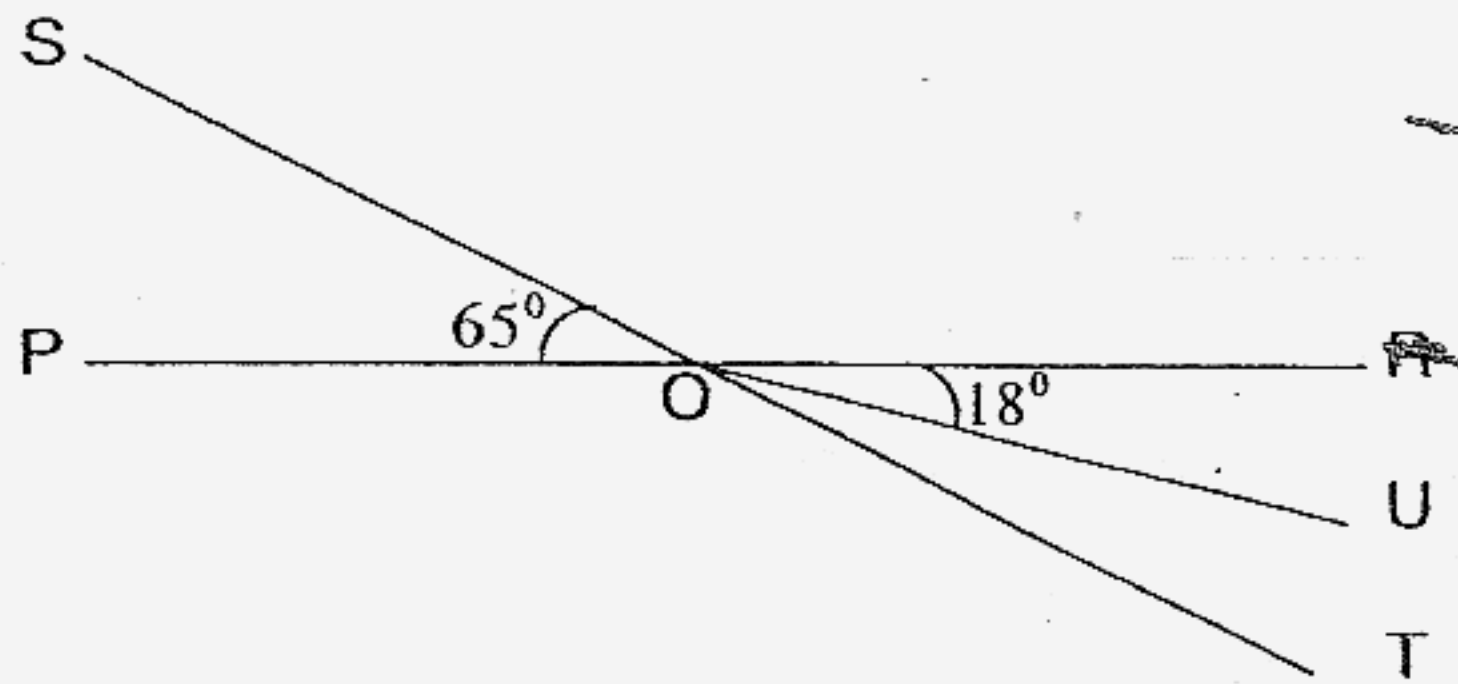

(1) 47°

(2) 83°

(3) 97°

(4) 115°

6) Which one of the following numbers is the largest?

- (1) 9.4
- (2) 9.04
- (3) 9.44
- (4) 9.044

7) Maggie can write 32 words in 2 minutes. At this rate, how many words can she write in 8 minutes?

- (1) 128
- (2) 144
- (3) 240
- (4) 256

8) ABCD is a rectangle. $DC = 20$ cm and $BC = 11$ cm. P is the mid-point of AB. Find the area of triangle PBC.

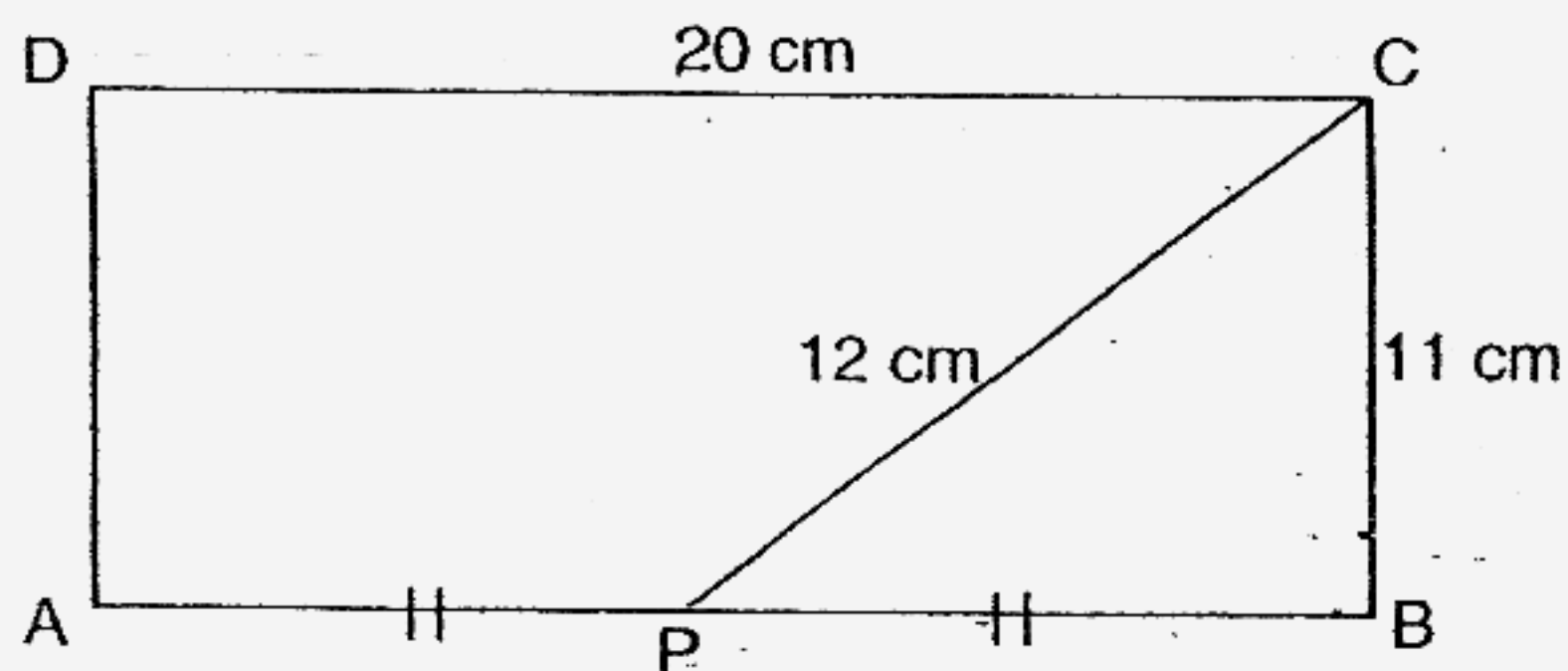

- (1) 55cm^2
- (2) 60cm^2
- (3) 66cm^2
- (4) 110cm^2

140

- 9) ABCD is a trapezium. Find $\angle x$.

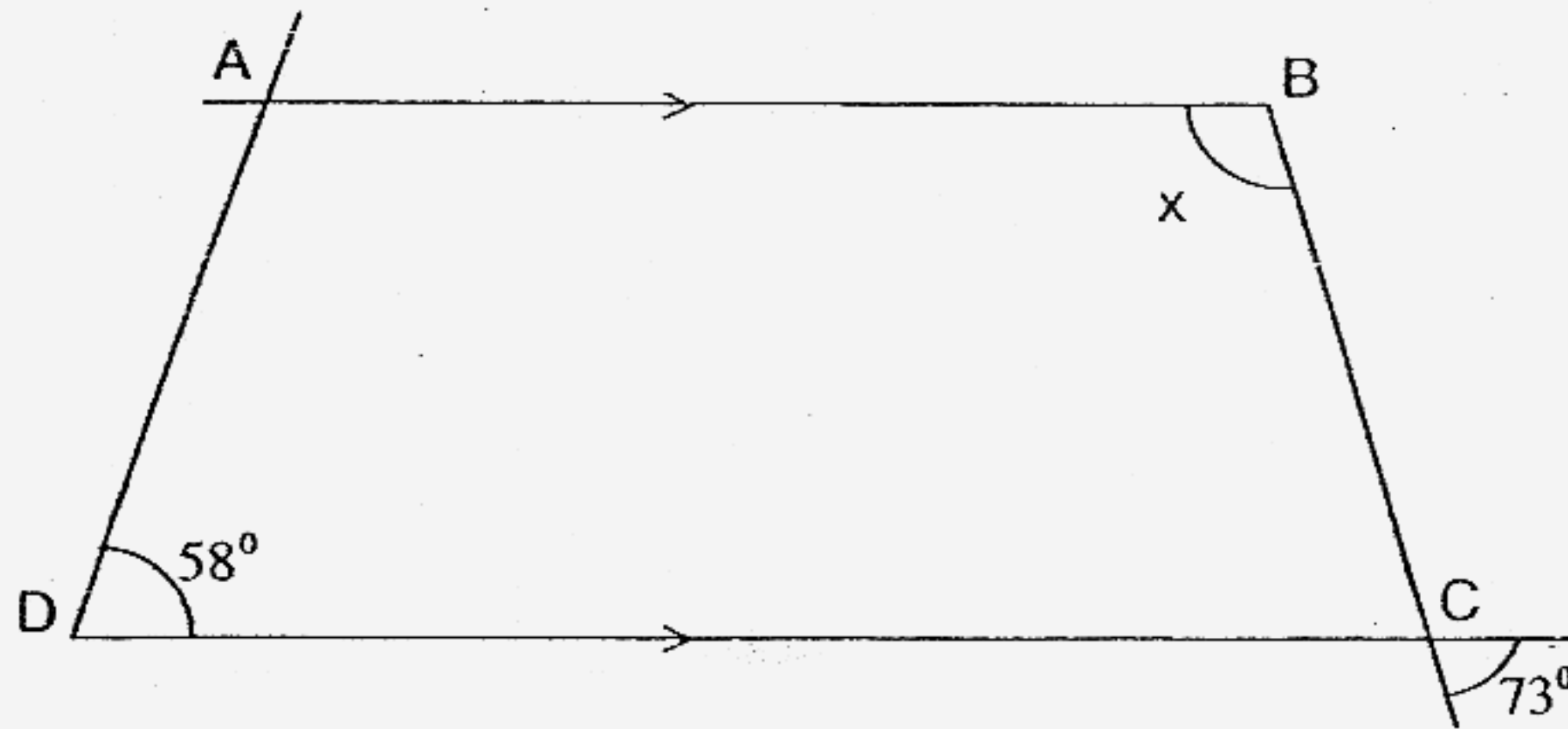

- (1) 58°
(2) 73°
(3) 107°
(4) 122°
- 10) The volume of the cube is 64 cm^3 . Find the length of one side of the cube.

- (1) 16 cm
(2) 8 cm
(3) 6 cm
(4) 4 cm

11) Look at the diagram below.

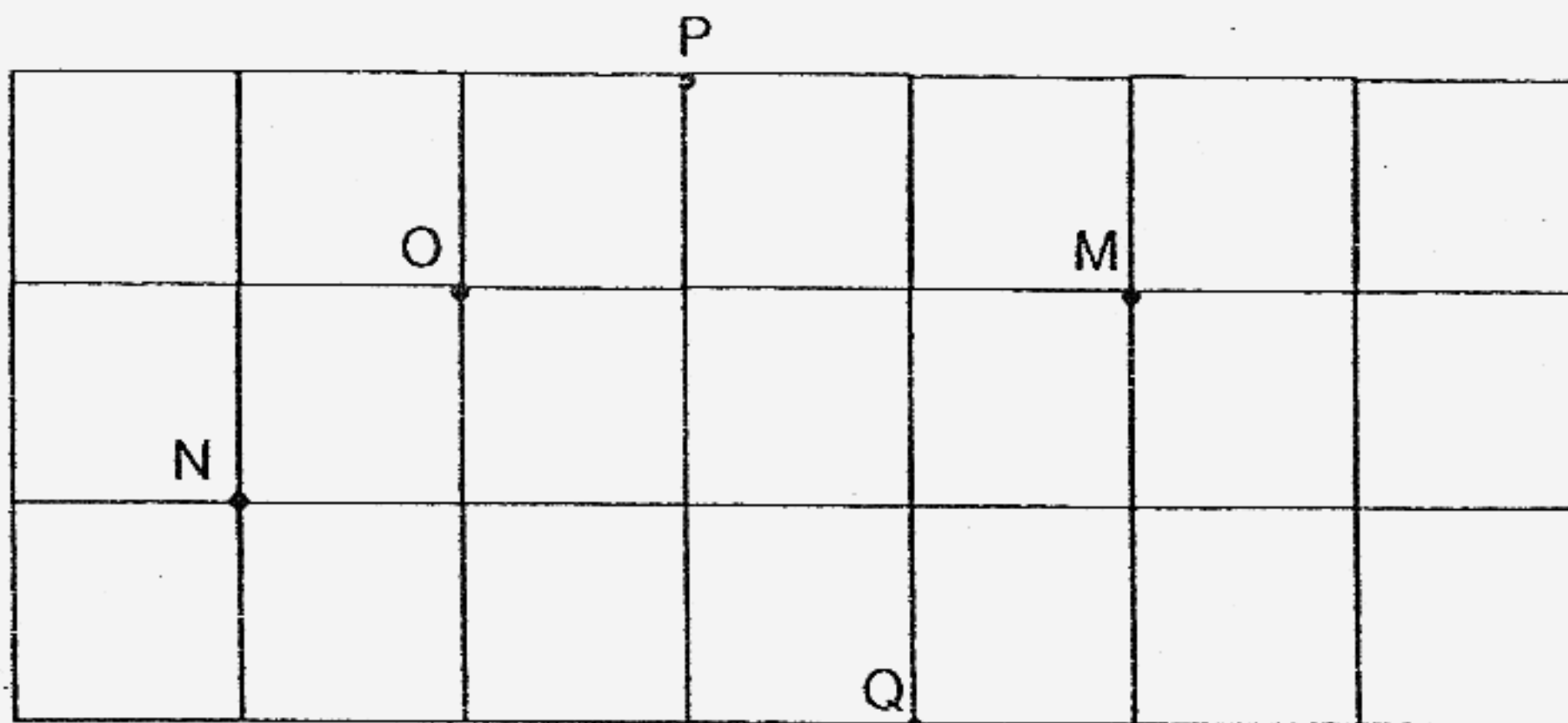

South-west of O is _____.

- (1) M
- (2) N
- (3) P
- (4) Q

12) Amy, Brenda and Carrie have a total sum of \$84. Amy and Brenda have \$54 altogether. What is the ratio of Carrie's share to the total sum of money?

- (1) 5 : 9
- (2) 5 : 14
- (3) 9 : 14
- (4) 9 : 23

13) 3 ducks cost \$72 and 6 chickens cost \$90. How much does 6 ducks and 9 chickens cost altogether?

- (1) \$273
- (2) \$279
- (3) \$289
- (4) \$324

14) A rectangular piece of paper, partly shaded, is folded to form the shape shown below. Express the shaded area below as a percentage of the area of the rectangular piece of paper before it was folded. (Figure is not drawn to scale)

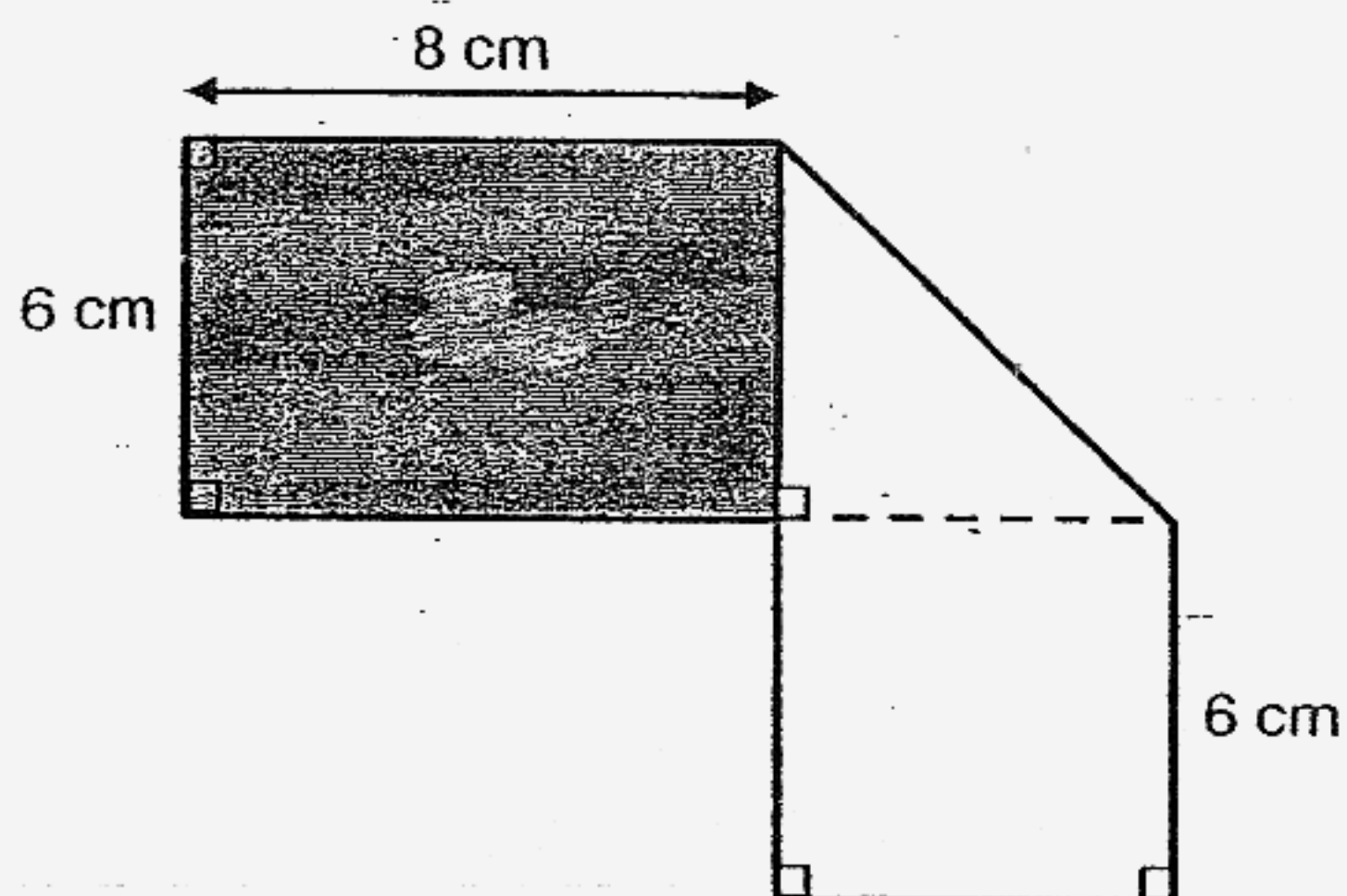

- (1) 40%
- (2) 44%
- (3) 47%
- (4) 50%

- 15) A rectangular piece of paper is folded in half. Using the folded edge as a base, three lines are drawn as shown below. The figure formed is then cut out and opened up. What is the area of the cut-out shape?

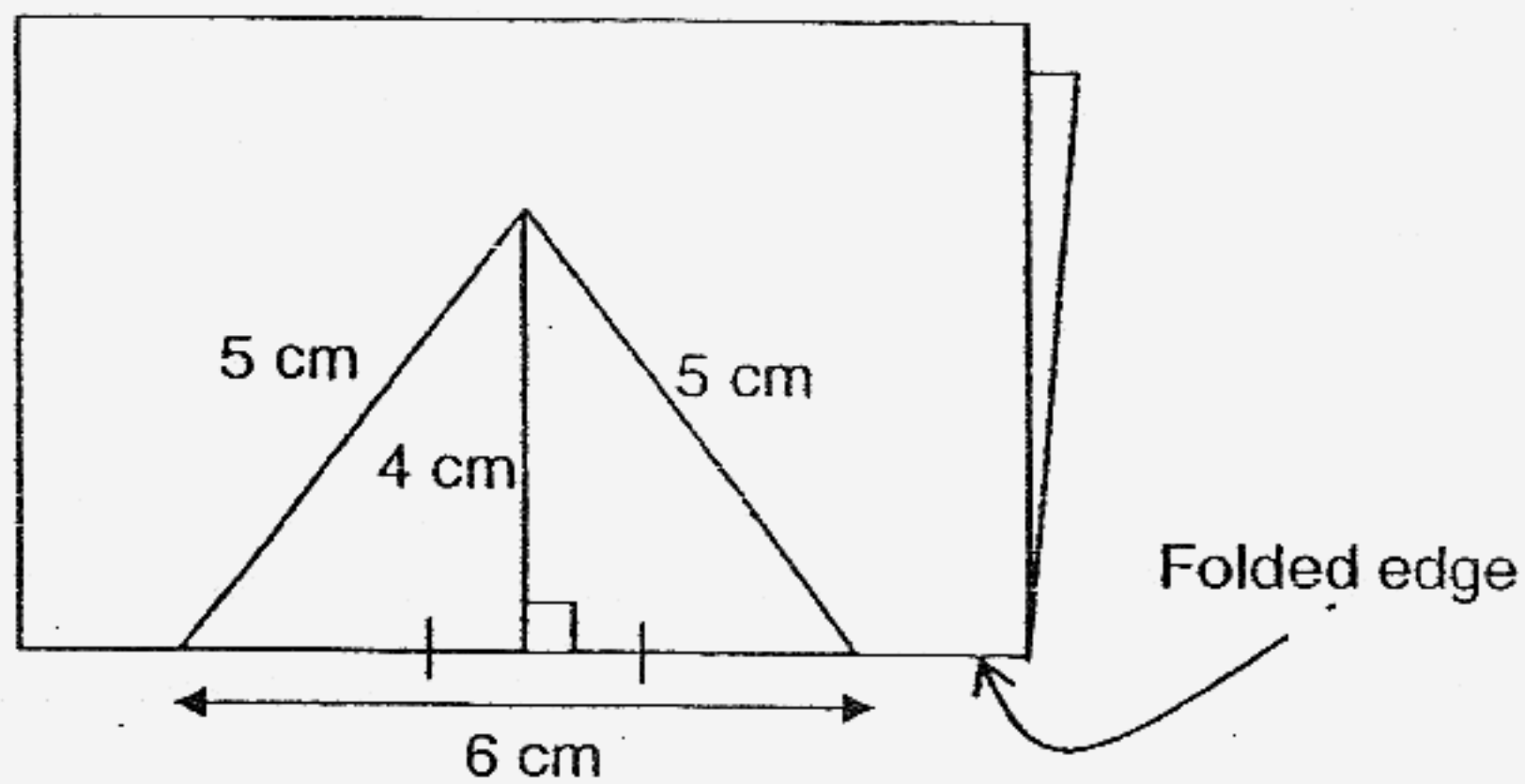

- (1) 12 cm^2
- (2) 24 cm^2
- (3) 30 cm^2
- (4) 60 cm^2

---END OF BOOKLET A---



Rosyth School
 Second Semestral Assessment 2007
 Mathematics
 Primary 5

Name: _____

Class: Pr 5-_____ Register No. _____

Date: 30 October 2007

Parent's Signature: _____

BOOKLET B

Instructions to Pupils:

1. Do not open this booklet until you are told to do so.
2. Follow all instructions carefully.
3. This booklet consists of Sections B and C.
4. For questions 26 to 48, show all relevant working in the spaces provided.
5. ANSWER ALL QUESTIONS.

	Maximum	Marks Obtained
Section B	30	
Section C	50	
Sub-Total	80	

* Booklet B consists of 17 pages altogether.

This paper is not to be reproduced in part or whole without the permission of the Principal.

Section B

Questions 16 to 25 carry 1 mark each. Write your answers in the spaces provided. For questions which require units, give your answers in the units stated. (10 marks)

- 16) A taxi can carry a maximum of 4 passengers. What is the least number of taxis needed to transport 17 passengers?

Ans: _____

- 17) Find the value of $130 \div 16$.
Leave your answer in decimals.

Ans: _____

- 18) Find the value of $\frac{5}{6} \times \frac{3}{10}$.
Leave your answer in its simplest form.

Ans: _____

- 19) 27 kg of rice are shared equally among 7 people. How much rice does each person get? Leave your answer in its simplest form.

Ans: _____ kg

- 20) Find the area of the triangle below.

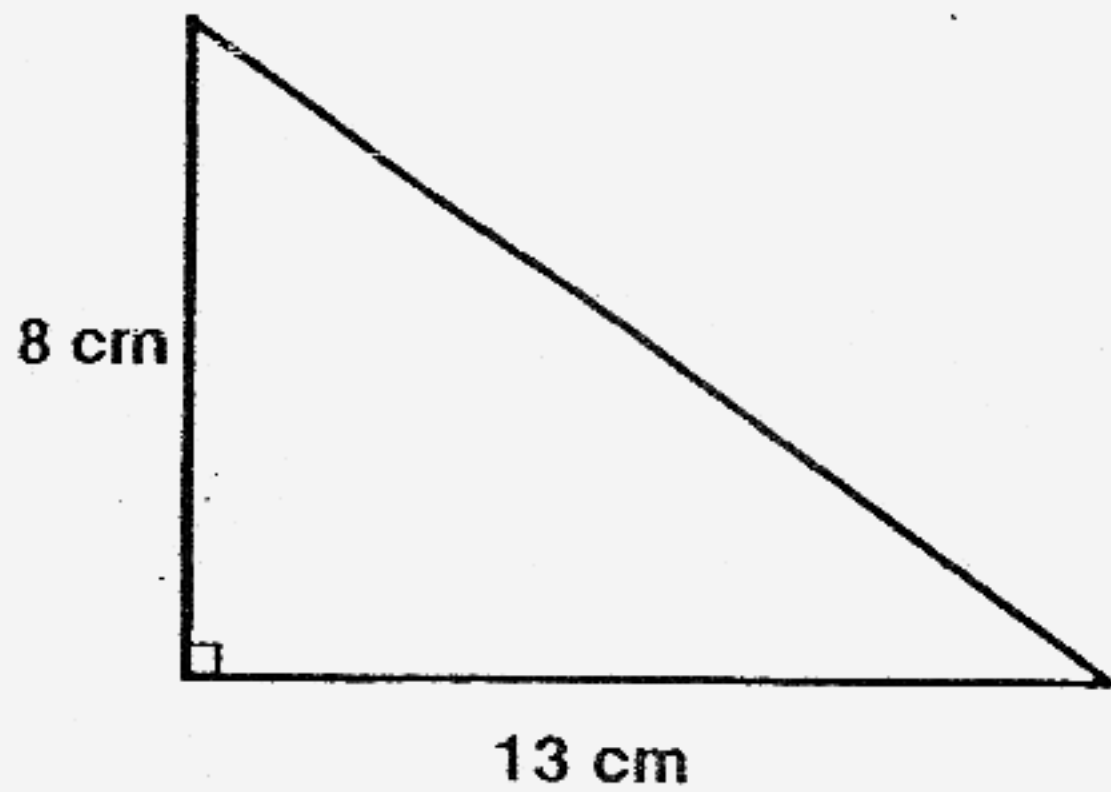

Ans: _____ cm^2

- 21) Round off 9.873 to 1 decimal place.

Ans: _____

- 22) Express $1\frac{1}{5}$ as a percentage.

Ans: _____ %

- 23) Ryan was given a 20% discount for a meal that cost \$5. How much did he pay for the meal?

Ans: \$ _____

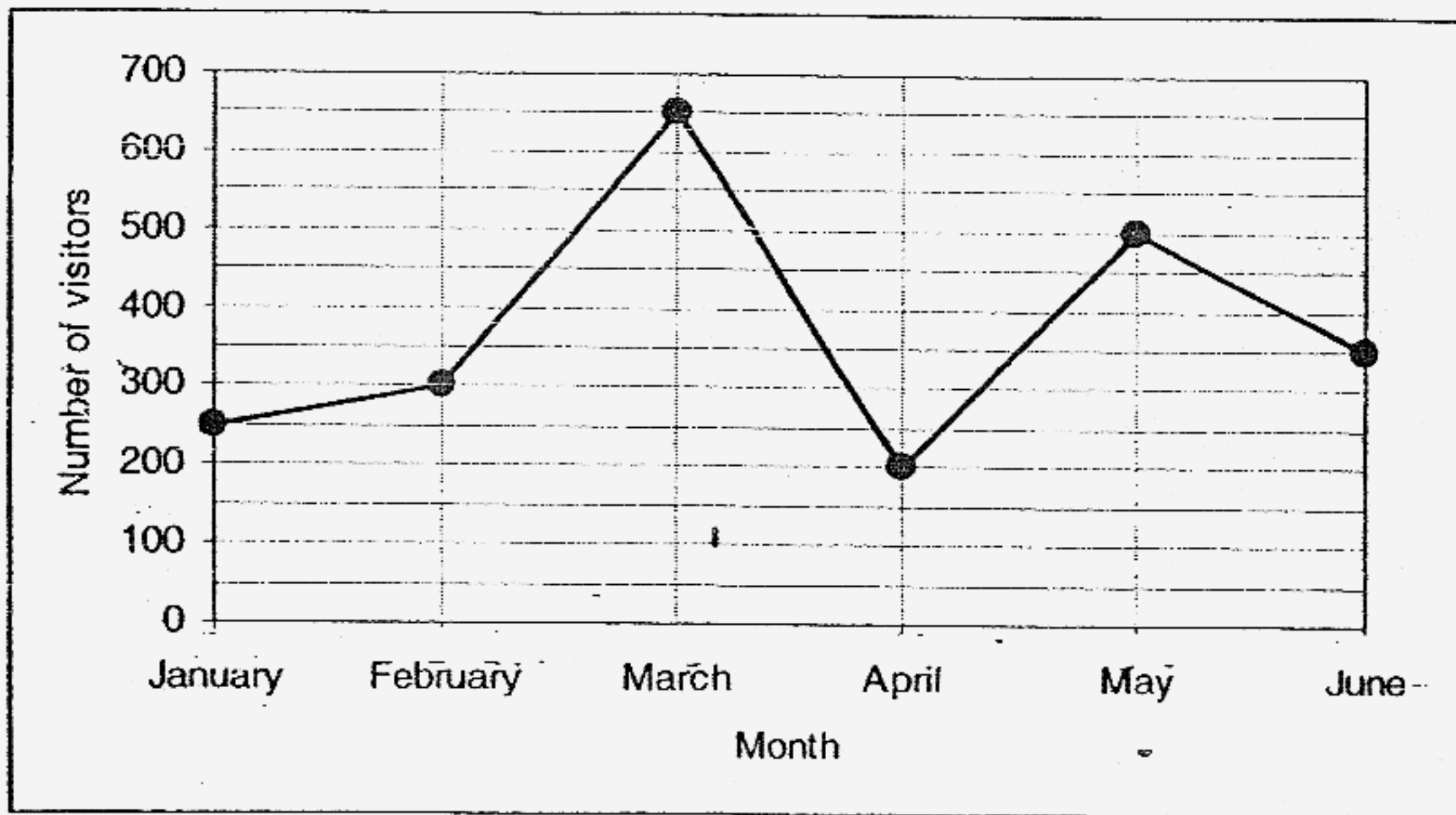

24) The line graph shows the number of visitors to the museum over 6 months. In which month was the number of visitors twice the number of visitors in January?

Ans: _____

25) The figure below is not drawn to scale. ABC is a straight line. Find $\angle a$.

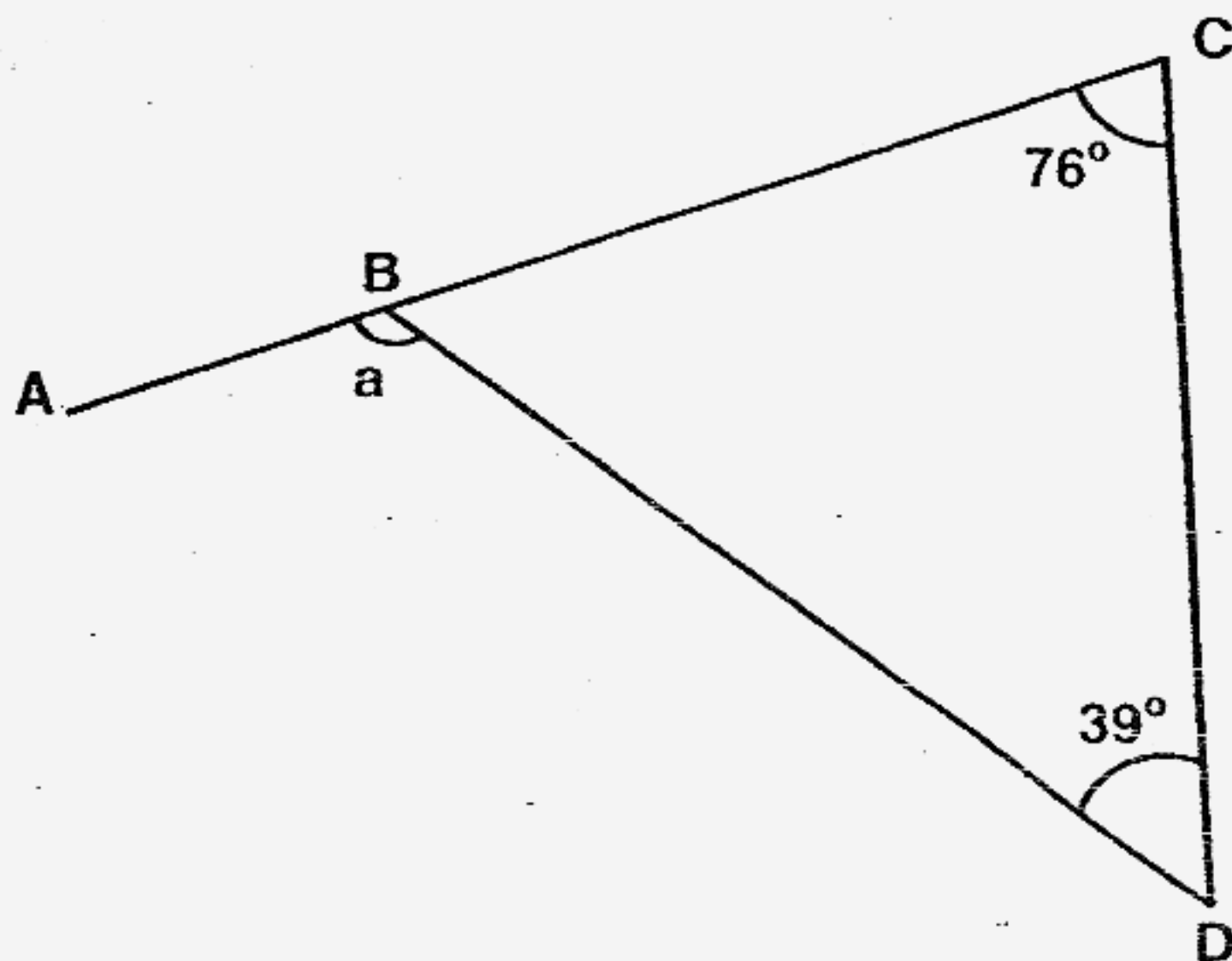

Ans: _____

Questions 26 to 35 carry 2 marks each. Show your working clearly in the space below each question and write your answers in the spaces provided. For questions which require units, give your answers in the units stated. (20 marks)

- 26) In every litre of apple juice, there is 400 ml of apple syrup. The rest of the juice is made up of water. How much water will there be in 2.5 litres of apple juice? Leave your answer in millilitres.

Ans: _____ ml

- 27) The figure below is not drawn to scale. Find $\angle r$.

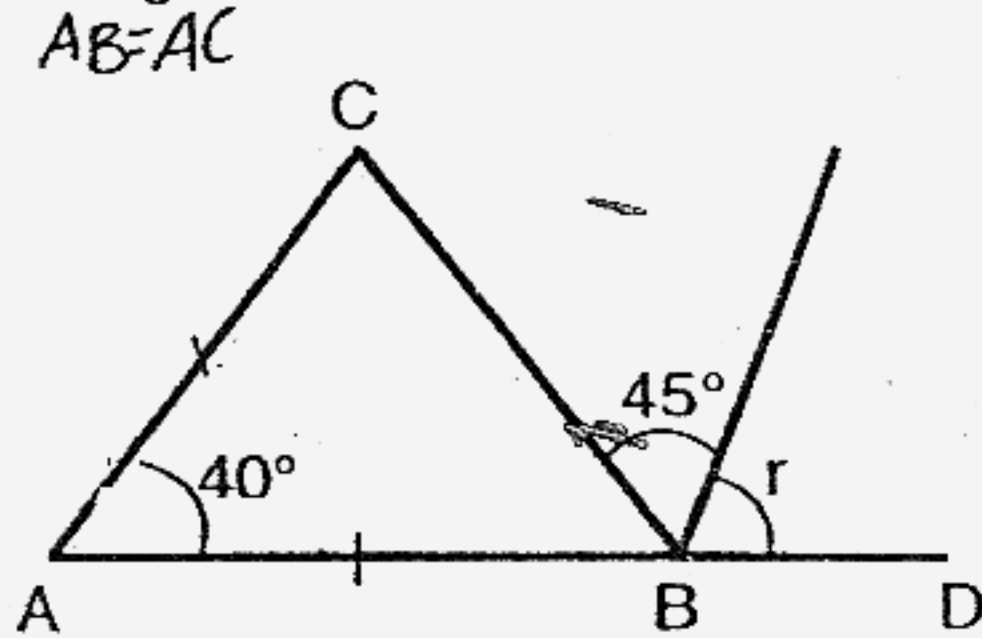

Ans: _____ °

- 28) Gerald was facing north-west. He made an anti-clockwise turn to face south. What angle did he turn through?

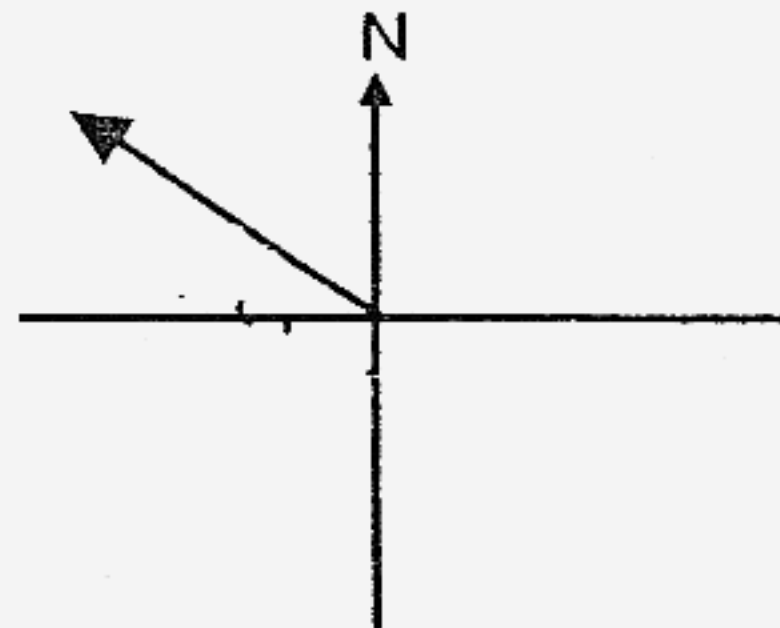

Ans: _____ °

- 29) The ratio of the perimeter of square A to the perimeter of square B is 4 : 6. If the perimeter of square B is 60 cm, find the difference between the perimeters of the two squares.

Ans: _____ cm

- 30) The square ABCD below has an area of 16 cm^2 . Find the area of the shaded part.

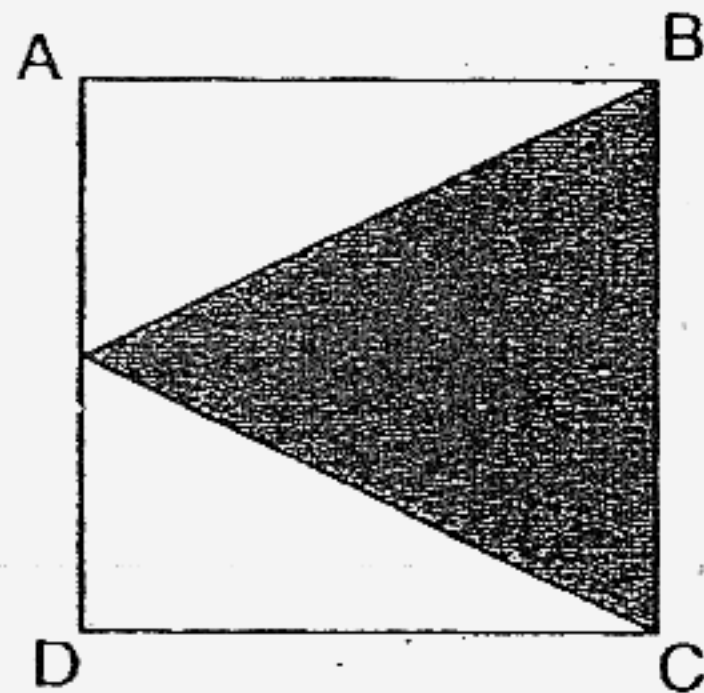

Ans: _____ cm^2

- 31) The figure below is not drawn to scale. Find $\angle RQS$.

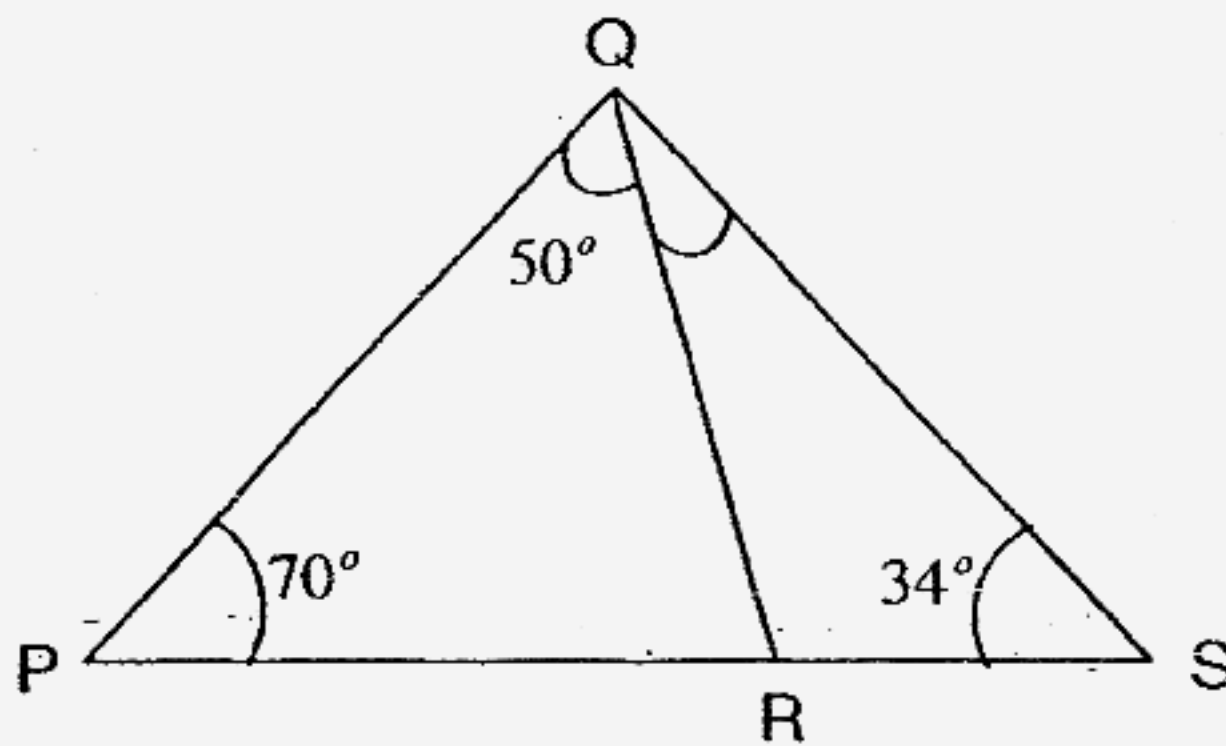

Ans: _____ °

- 32) Mrs Lee has some pencils. If she packs them into bundles of 5 pencils in each bundle, she will have 4 extra pencils. If she packs them into bundles of 9 pencils in each bundle, she will need 7 more pencils. How many pencils are there?

Ans: _____

- 33) The table below shows the parking rate at a car park in the city.

8 a.m. to 6 p.m.	\$2.50 per hour or part thereof
After 6 p.m.	\$0.50 per hour or part thereof.

Mr. Teo parked his car from 3 p.m. to 8.30p.m. at the car park. How much did he have to pay?

Ans: \$ _____

- 34) A wooden block measures 10 cm by 8 cm by 2.5 cm. If 4 such wooden blocks are packed exactly into a rectangular box, what is the capacity of the box?

Ans: _____ cm^3

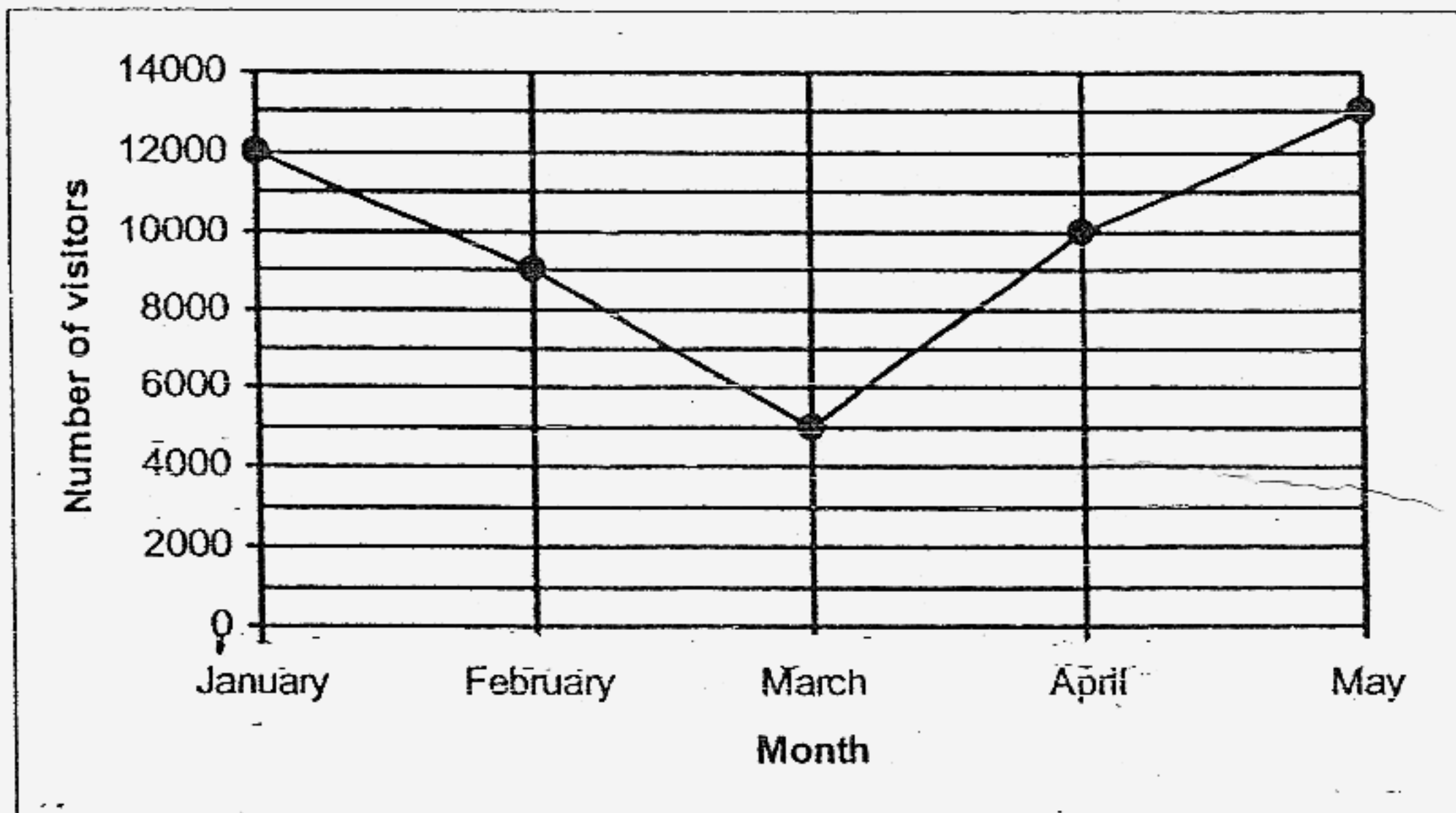

- 35) The graph above shows the number of visitors who visited the Night Safari from January to May. What is the average monthly number of visitors who visited the Night Safari over the 5 months?

Ans: _____

Section C

For questions 36 to 48, show your working clearly in the space provided for each question and write your answers in the spaces provided.

The number of marks available is shown in brackets [] at the end of each question or part question. (50 marks)

- 36) There are 500 Primary 5 pupils in Rosyth. 22% of them go to school by car, while 58% of them go to school by bus. The rest of the Primary 5 pupils walk to school. How many Primary 5 pupils walk to school?

Ans: _____ [3]

- 37) There were 60 more women than men at a party. $\frac{3}{4}$ of the men and $\frac{1}{3}$ of the women wore watches. The number of women and the number of men who wore watches were the same. How many adults wore watches?

Ans: _____ [3]

- 38) Luna, Ginny and Padma shared a pack of stickers in the ratio 7 : 5 : 3. The total number of stickers Luna and Ginny have is 36 more than Padma's share. Find the total number of stickers shared by the 3 girls.

Ans: _____ [3]

- 39) Water flows out of a rectangular tank at a rate of 600 ml per minute. Find the time it takes for the water level to fall by 8 cm. Leave your answer in minutes.

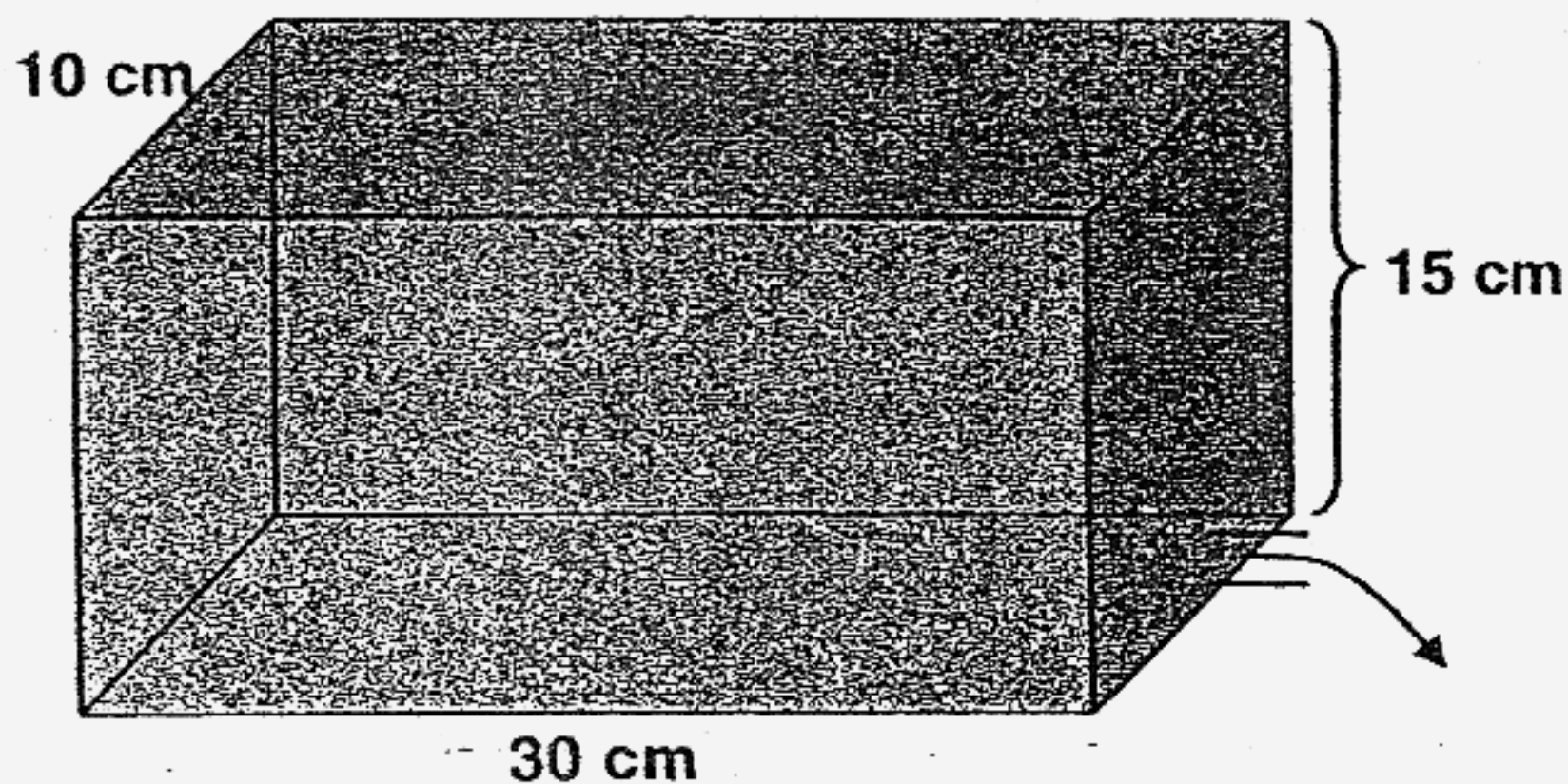

Ans: _____ [3]

- 40) The average number of letters in six magic spells is 9. Four of the spells are LUMÓS, CRUCIÓ, PROTEGO and CÓNFUNDO. The 2 remaining spells have the same number of letters. How many letters does each of the 2 spells have?

Ans: _____ [3]

- 41) The figure below, not drawn to scale, is made up of 2 squares of different sizes. Find the area of the shaded region.

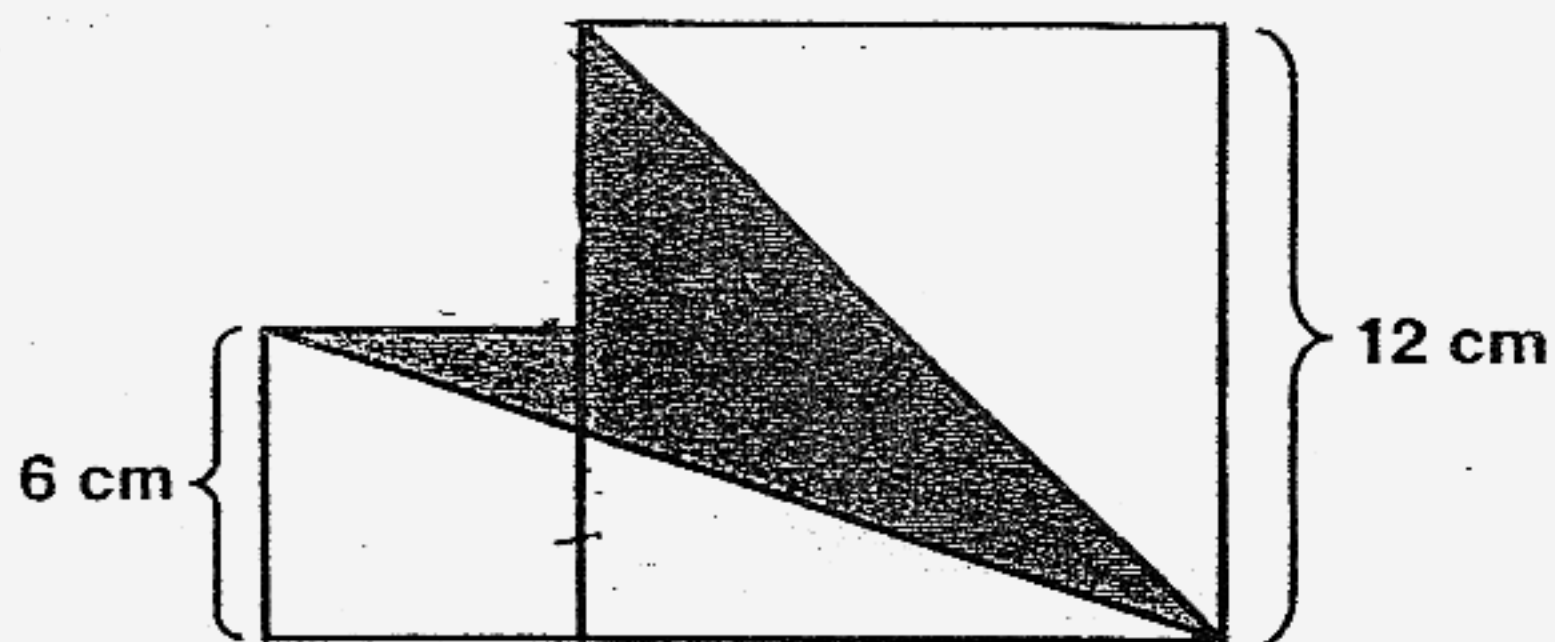

Ans: _____ [3]

- 42) A bus was three bus stops away from the bus terminal.
At the first bus stop, 10 passengers got on and 7 passengers got off.
At the second bus stop, no passengers got on and 9 passengers got off.
At the third bus stop, 12 passengers got on and no passengers got off.
When the bus arrived at the terminal, all 51 passengers got off.
How many passengers were on the bus just before it arrived at the first bus stop?

Ans: _____ [4]

- 43) A box contains balls, sticks and nets. $\frac{1}{4}$ of the items in the box are balls. The ratio of the number of sticks to the number of nets is 10 : 3. There are 42 more sticks than nets. How many items are there in the box altogether?

Ans: _____ [4]

- 44) Sirius and Minerva shared some money in the ratio 2 : 5. Sirius bought a deck of cards for \$16 and donated $\frac{1}{4}$ of his remaining money. He had \$27 left. What was the total sum of money Sirius and Minerva had at first?

Ans: _____ [4]

45) A set of value meal consists of a hamburger, an apple pie and a can of juice. The hamburger costs \$1.90 more than the apple pie. The apple pie costs \$0.80 more than the can of juice. The total cost of 5 sets of the value meal is \$37.

- (a) Find the cost of the can of juice.
- (b) Find the cost of 5 hamburgers.

Ans: (a) _____ [3]

(b) _____ [2]

159

- 46) Hogwarts Photography Club has 1150 members. 20% of the men and 25% of the women are non-professional photographers. A total of 250 members are non-professional photographers. How many more men than women are there in the club?

Ans: _____ [5]

47) At a book fair, Gideon spent \$6 less than $\frac{5}{8}$ of his money on story books and \$2 more than $\frac{7}{9}$ of his remaining money on reference books. After buying the books, he still had \$10 left.

- (a) How much money was left after Gideon bought his story books and before he bought the reference books?
- (b) How much money did Gideon have at first?

Ans: (a) _____ [2]

(b) _____ [3]

- 48) There were two identical flights of steps. For the first flight of steps, Albus walked up some steps and ran 4 steps, and took a total of 75 seconds. For the second flight of steps, Albus walked up some steps and ran 11 steps, and took a total of 40 seconds. How long will Albus take if he had walked up both flights of steps? Leave your answer in seconds.

Ans: _____ [5]

-END OF PAPER-

Have you checked your work thoroughly?

Rosyth Primary School

Primary 5 Maths SA2 Exam (2007)*Answer Keys*

Q1	Q2	Q3	Q4	Q5
4	2	4	2	1
Q6	Q7	Q8	Q9	Q10
3	1	1	3	4
Q11	Q12	Q13	Q14	Q15
2	2	2	1	2

16. 5 taxis

17. 8.125

18. $\frac{1}{4}$ 19. $3\frac{1}{7}$ kg20. 52cm²

21. 9.9

22. 120%

23. \$4.00

24. May

25. 115°

26. 1500ml

27. 65°

28. 135°

29. 20cm

30. 8

31. 26°

32. 29

33. \$9

34. 800cm³

35. 9800 visitors

36. $22 + 58 = 80$ $100 - 80 = 20$ $\frac{20}{100} \times 500 = 100$

100 primary 5 pupils walk to school.

37.

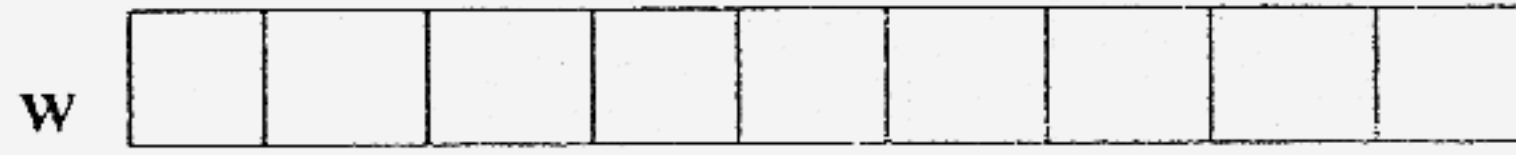
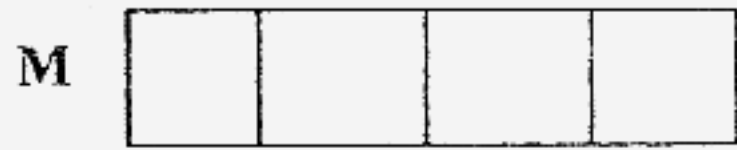

$$60 \div 5 = 12$$

$$12 \times 6 = 72$$

72 adults wore watches

38.

$$L : G : P$$

$$7 : 5 : 3$$

$$7 + 5 - 3 = 9$$

$$7 + 5 + 3 = 15u$$

$$9u = 36$$

$$1u = 4$$

$$15u = 15 \times 4 = 60 \text{ stickers}$$

39.

$$10 \times 30 = 300$$

$$300 \times 8 = 2400$$

$$2400 \div 600 = 4$$

It takes 4 minutes for the water level to fall by 8cm.

40.

$$9 \times 6 = 54$$

$$5 + 6 + 7 = 18$$

$$18 + 8 = 26$$

$$54 - 26 = 28$$

$$28 \div 2 = 14$$

Each of the two spells have 14 letters.

41.

$$12 + 6 = 18$$

$$\frac{1}{2} \times 18 \times 6 = 54$$

$$\frac{1}{2} \times 12 \times 12 = 72$$

$$6 \times 6 = 36$$

$$12 \times 12 = 144$$

$$144 + 36 = 180$$

$$180 - 12 = 54\text{cm}^2$$

The area of the shaded region is 54cm^2

42. $51 - 12 = 39$
 $39 + 9 = 48$
 $48 - 10 = 38$
 $38 + 7 = 45$
 45 passengers were on the bus before it arrived at the first bus stop.

43. $10 - 3 = 7$
 $42 \div 7 = 6$
 $6 \times 13 = 78$
 $78 \div 3 = 26$
 $26 + 78 = 104$
 There are 104 item in the box altogether.

44. $27 \div 3 = 9$
 $9 \times 4 = 36$
 $36 + 16 = 52$
 $52 \div 2 = 26$
 $26 \times 7 = 182$
 The total sum of money Sirius and Minerva had at first was \$182.00

- 45a. $\$(0.80 \times 2) = \1.60
 $\$(1.60 + 1.90) = \3.50
 $\$(7.40 - 3.50) = \3.90
 $\$(3.90 \div 3) = \1.30
 The cost of the can of juice of \$1.30

- 45b. $\$(1.30 + 0.80) = \2.10
 $\$(2.10 + 1.90) = \4.00
 $\$(4.00 \times 5) = \20.00
 The cost of 5 hamburgers is \$20.00

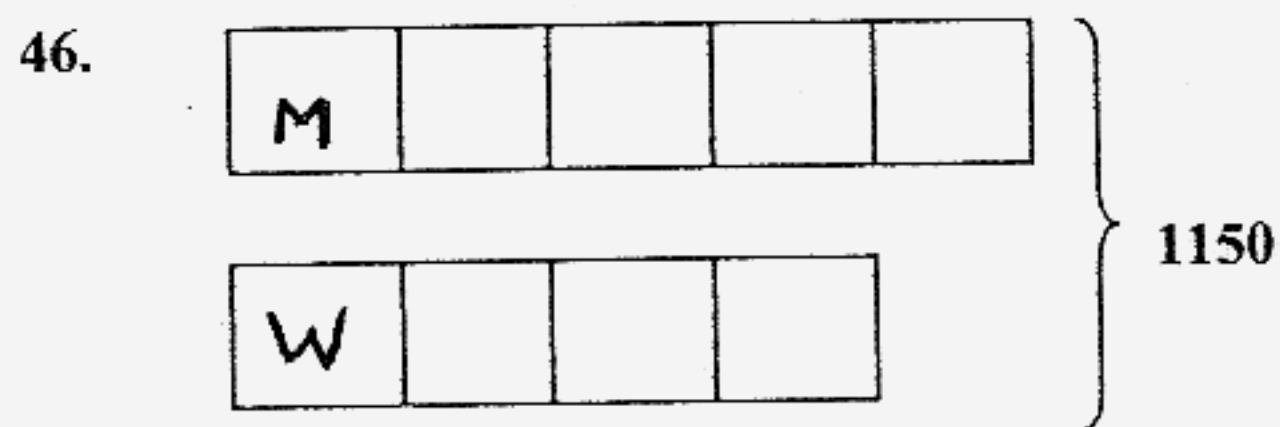

$$1M = 1W = 250$$

$$4M + 4W = 250 \times 4 = 1000$$

$$5M + 4W = 1150$$

$$1M = 1150 - 1000 = 150$$

$$5M = 150 \times 5 = 750 \text{ men}$$

$$4W = 1150 - 750 = 400 \text{ women}$$

$$750 - 400 = 350$$

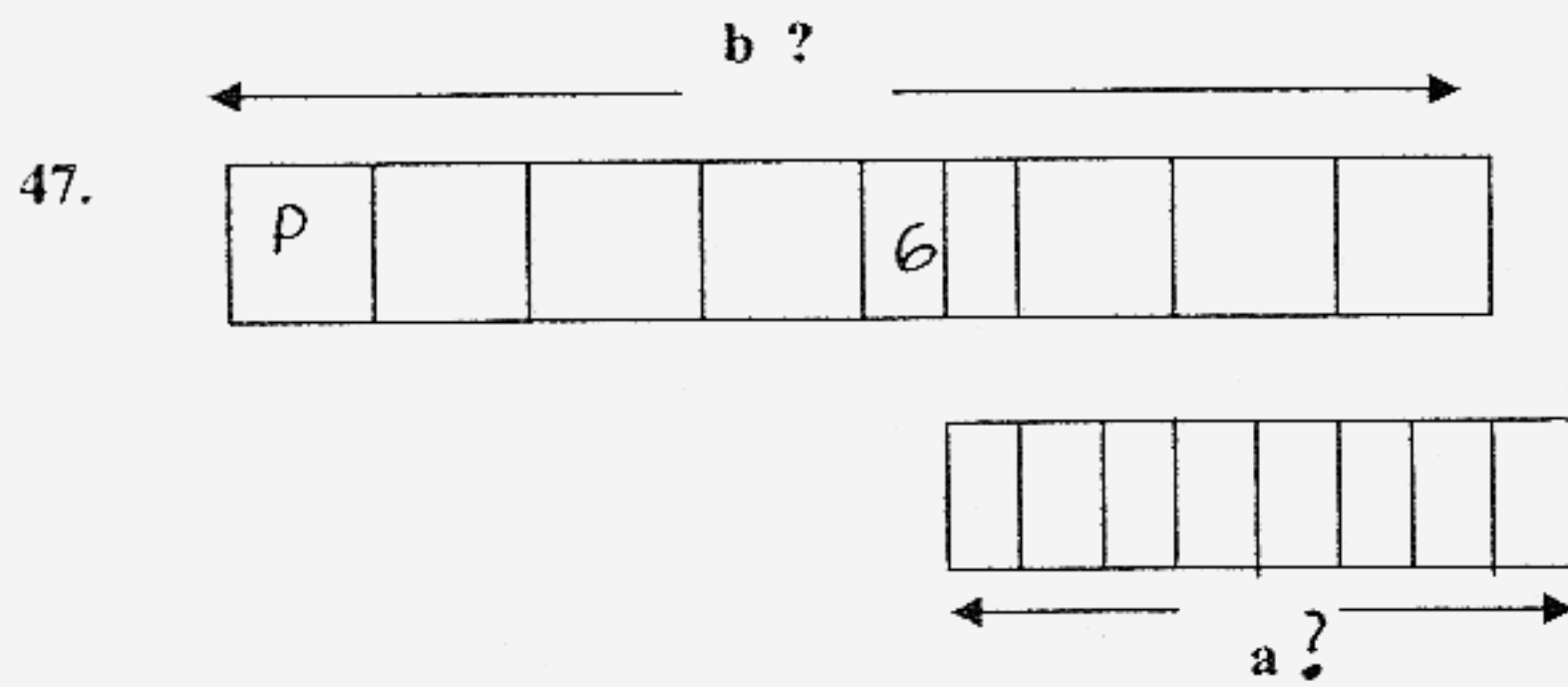

a. $2u = \$10 + \$2 = \$12.00$

$$1u = \frac{12}{2} = \$6$$

$$9u = 9 \times \$6 = \$54$$

b. $3 \text{ parts} = \$54 - \$6 = \$48$

$$1 \text{ part} = \$16$$

$$8 \text{ parts} = \$16 \times 8 = \$128$$

48. $11 - 4 = 7$

Difference between and walking

$$7 \text{ steps} = 75 - 40 = 35 \text{ seconds}$$

$$1 \text{ step} = \frac{35}{7} = 5 \text{ seconds}$$

$$4 \times 5 = 20$$

$$75 + 20 = 95$$

$$95 + 75 = 190 \text{ seconds}$$