

**NANYANG PRIMARY SCHOOL**  
**SECOND SEMESTRAL EXAMINATION**  
**2007**

**PRIMARY 5**  
**MATHEMATICS**

**DURATION: 2 HOURS 15 MINUTES**

<b>Booklet A</b>	<b>/ 20</b>
<b>Booklet B</b>	<b>/ 30</b>
	<b>/ 50</b>

<b>Total:</b>	<b>/ 100</b>
---------------	--------------

Name: \_\_\_\_\_ ( )

Class: Primary 5 ( )

Date: 31 October 2007

Parent's Signature: \_\_\_\_\_

DO NOT OPEN THIS BOOKLET UNTIL YOU ARE TOLD TO DO SO.

FOLLOW ALL INSTRUCTIONS CAREFULLY.

ANSWER ALL QUESTIONS.

**Booklet A**

Questions 1 to 10 carry 1 mark each. Questions 11 to 15 carry 2 marks each. For each question, four options are given. One of them is the correct answer. Make your choice (1, 2, 3 or 4). Shade the oval (1, 2, 3 or 4) on the Optical Answer Sheet.

(20 marks)

---

1 Find the value of  $11 + 8 \times 4 - 16 \div 8$ .

(1) 27

(2) 38

(3) 41

(4) 74

2 There was  $\frac{3}{4}$  l of milk in the bottle at first. Mrs Keong used  $\frac{1}{3}$  of it to bake a cake. How much milk was left?

(1)  $\frac{1}{4}$  l

(2)  $\frac{5}{12}$  l

(3)  $\frac{1}{2}$  l

(4)  $\frac{2}{3}$  l

3. What is the height of triangle ABC if the base is AC?

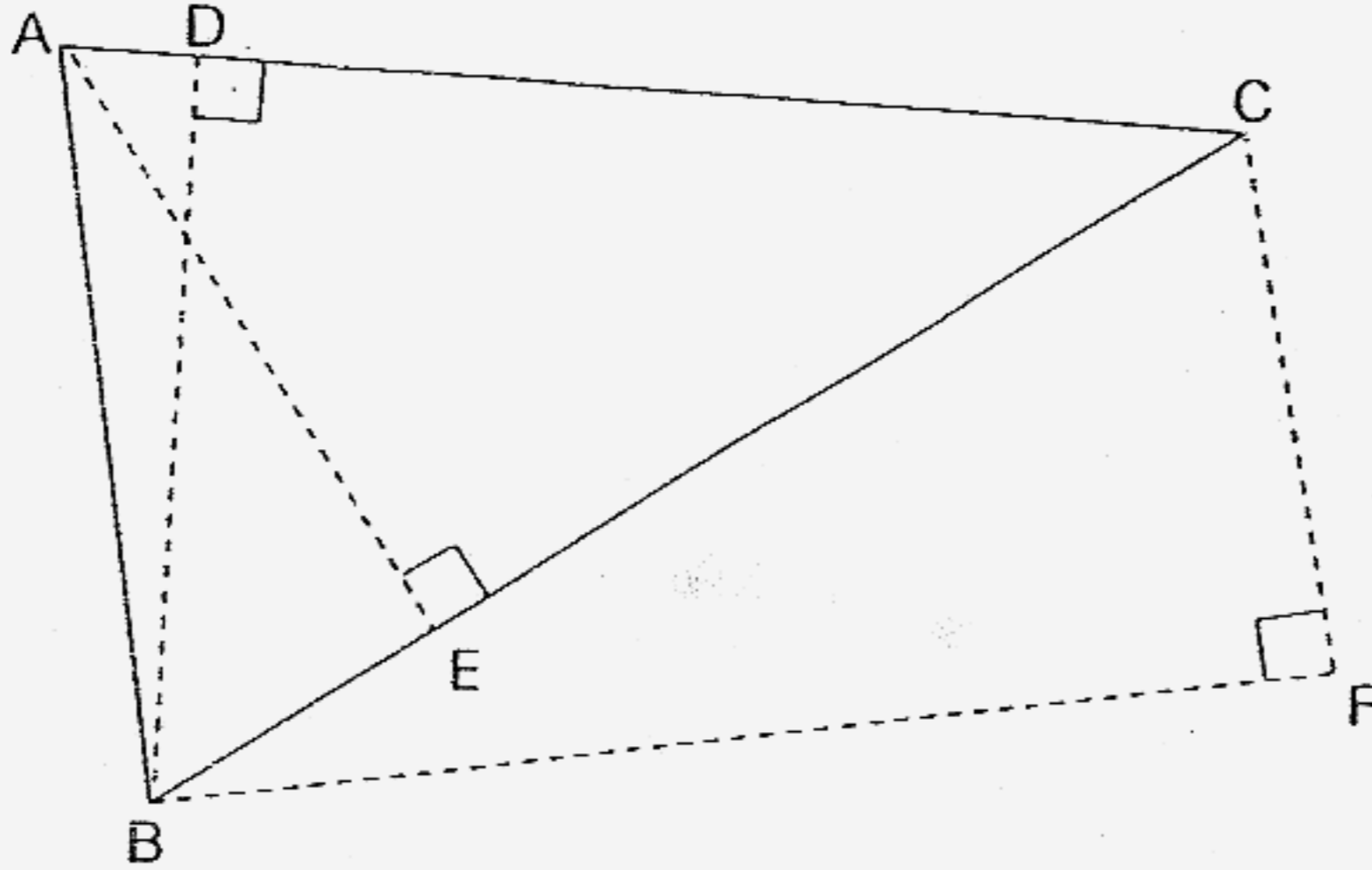

- (1) AB  
(2) BD  
(3) AE  
(4) CF
4. There are 15 red, 24 blue and 36 yellow buttons in a box. What is the ratio of the number of red buttons to the total number of blue and yellow buttons in the box?

- (1) 1 : 4  
(2) 1 : 5  
(3) 5 : 13  
(4) 5 : 17

- 5 AB and CD are straight lines. Find  $\angle w$ .

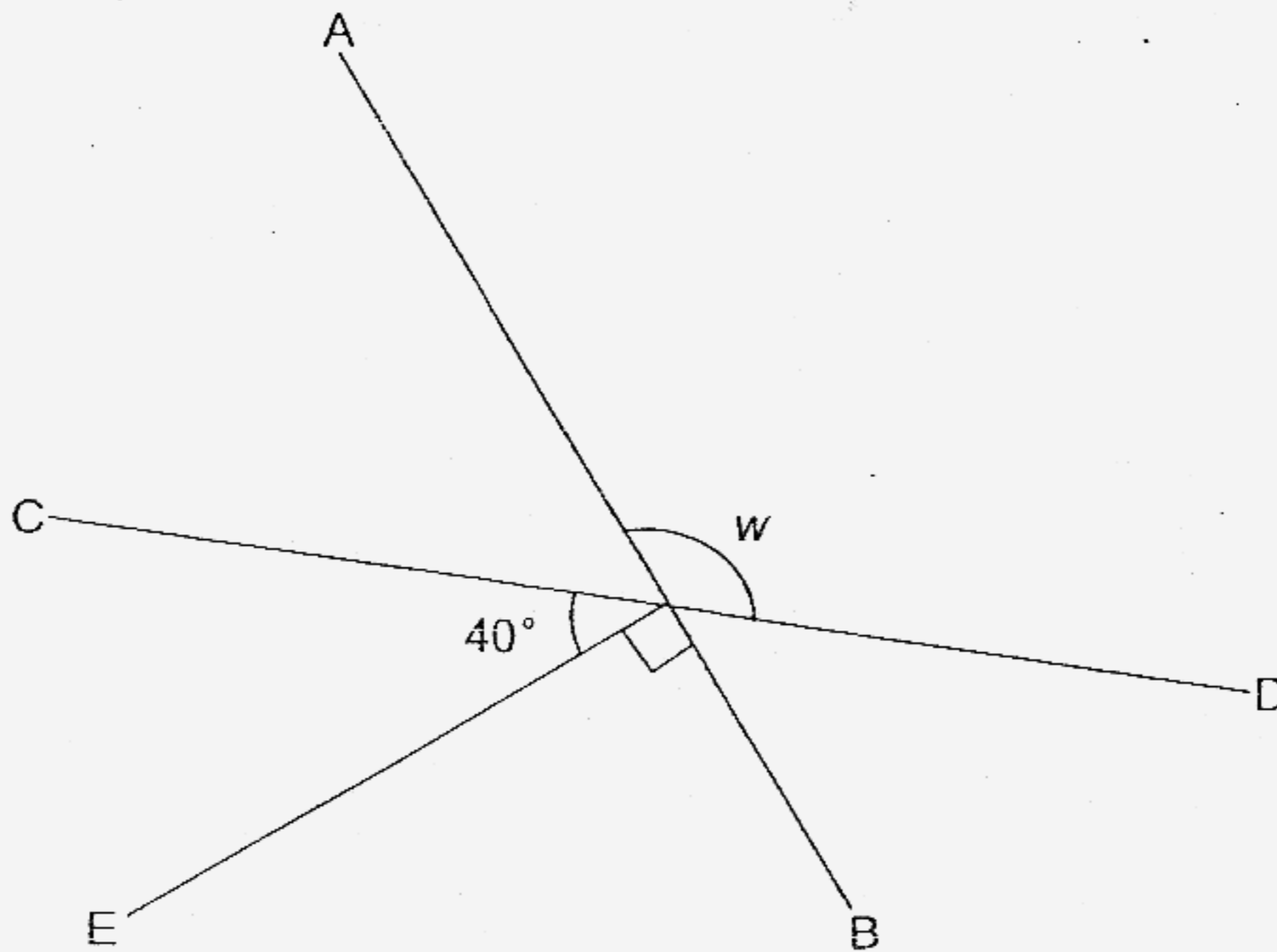

- (1)  $40^\circ$   
(2)  $50^\circ$   
(3)  $130^\circ$   
(4)  $140^\circ$
- 6 What is the value of  $0.4 \times 1000$  ?

- (1) 0.0004  
(2) 40  
(3) 400  
(4) 4000

- 7 Peter spent half an hour shopping before he watched a movie for 2 hours and 20 minutes. How much time did he spend in all?

(1)  $1\frac{5}{6}$  h

(2)  $1\frac{7}{10}$  h

(3)  $2\frac{7}{10}$  h

(4)  $2\frac{5}{6}$  h

- 8 In a class of 40 pupils, there are 15 girls. What percentage of the class are boys?

(1) 25%

(2) 37.5%

(3) 60%

(4) 62.5%

- 9 The graph below shows the savings of Ahmad and Fatimah from April to July.

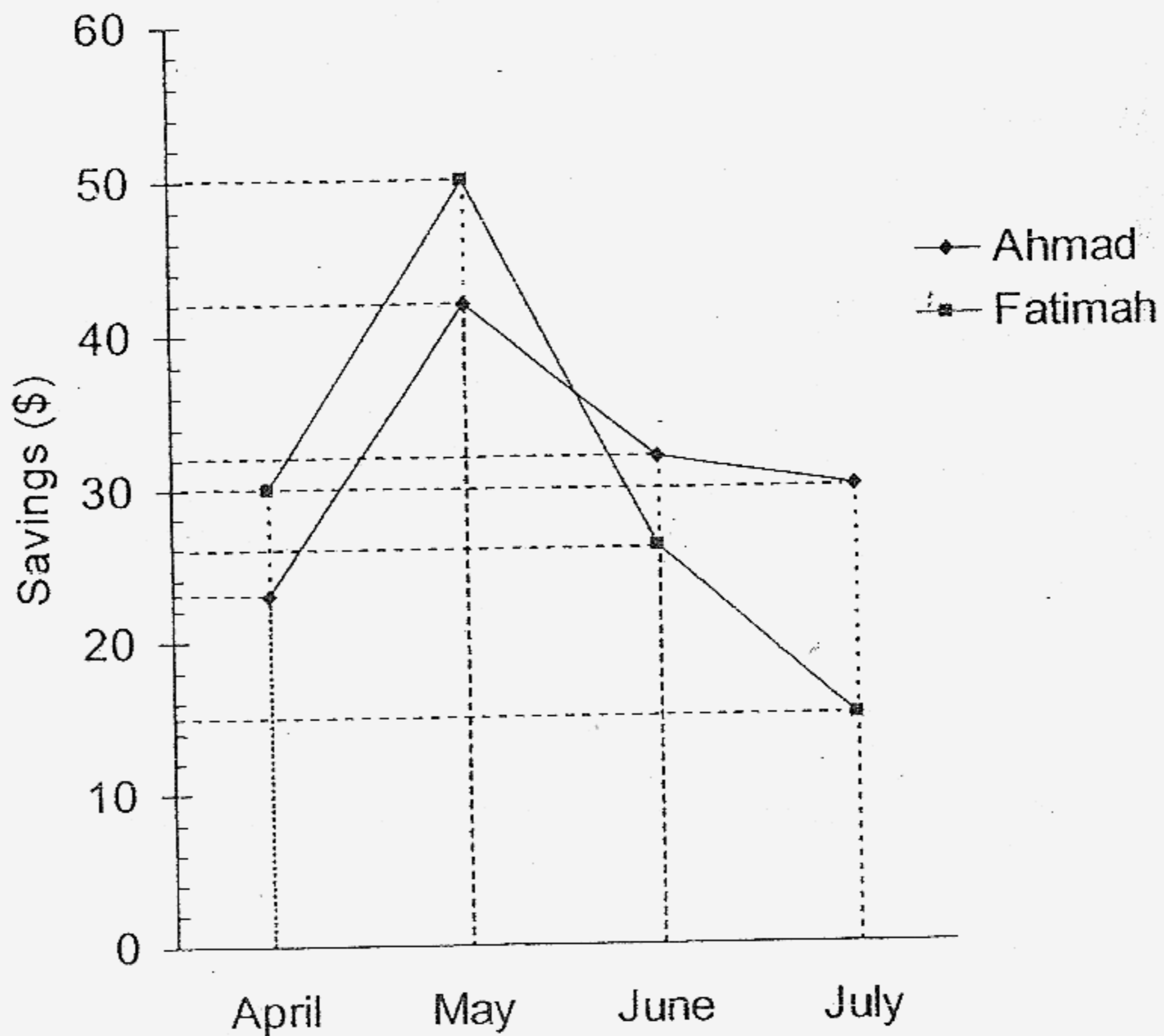

What is the difference in the decrease in their savings from May to June?

- (1) \$10
- (2) \$14
- (3) \$24
- (4) \$34

- 10 In the figure below, ABC is an isosceles triangle. BCD is a straight line. Find  $\angle x$ .

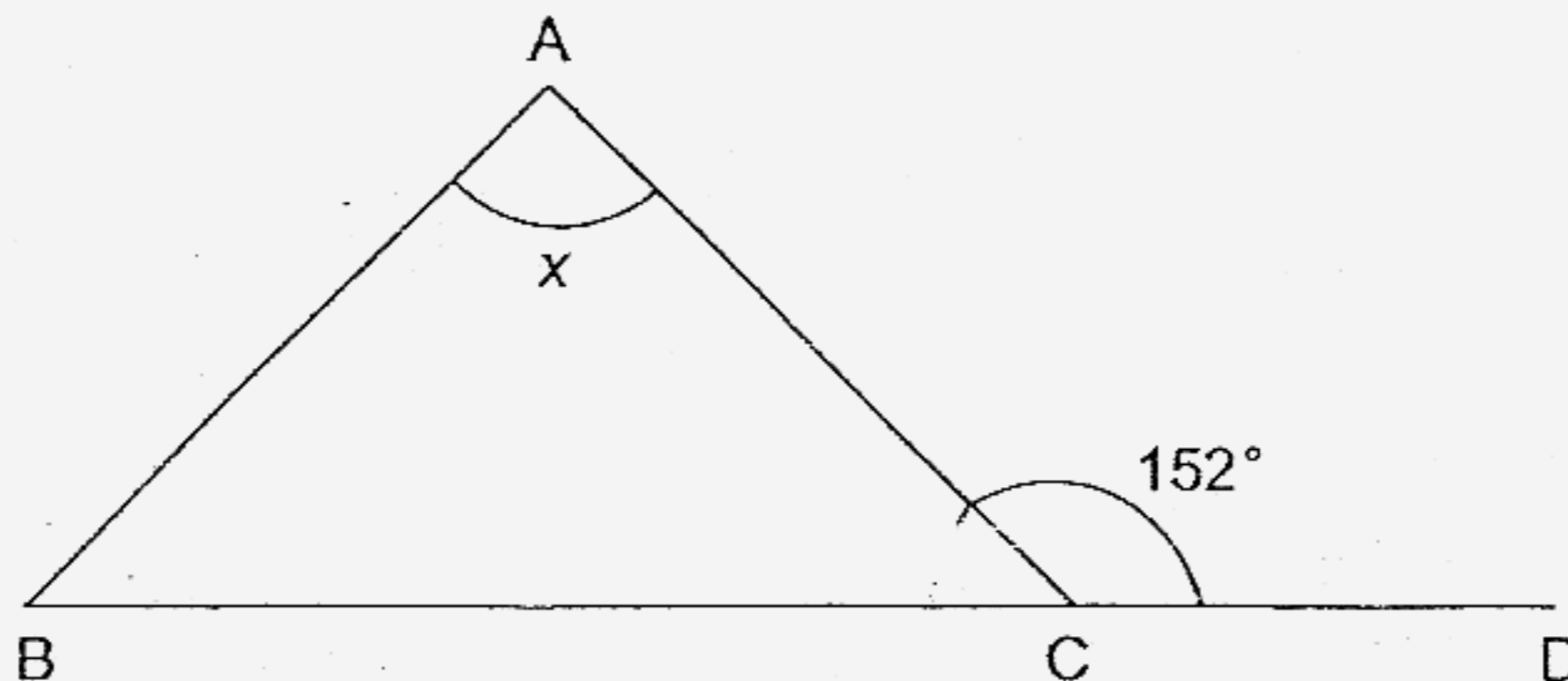

- (1)  $56^\circ$
- (2)  $76^\circ$
- (3)  $104^\circ$
- (4)  $124^\circ$

- 11 In the figure, PQRS is a rhombus. TSQ is a straight line. Find  $\angle RST$ .

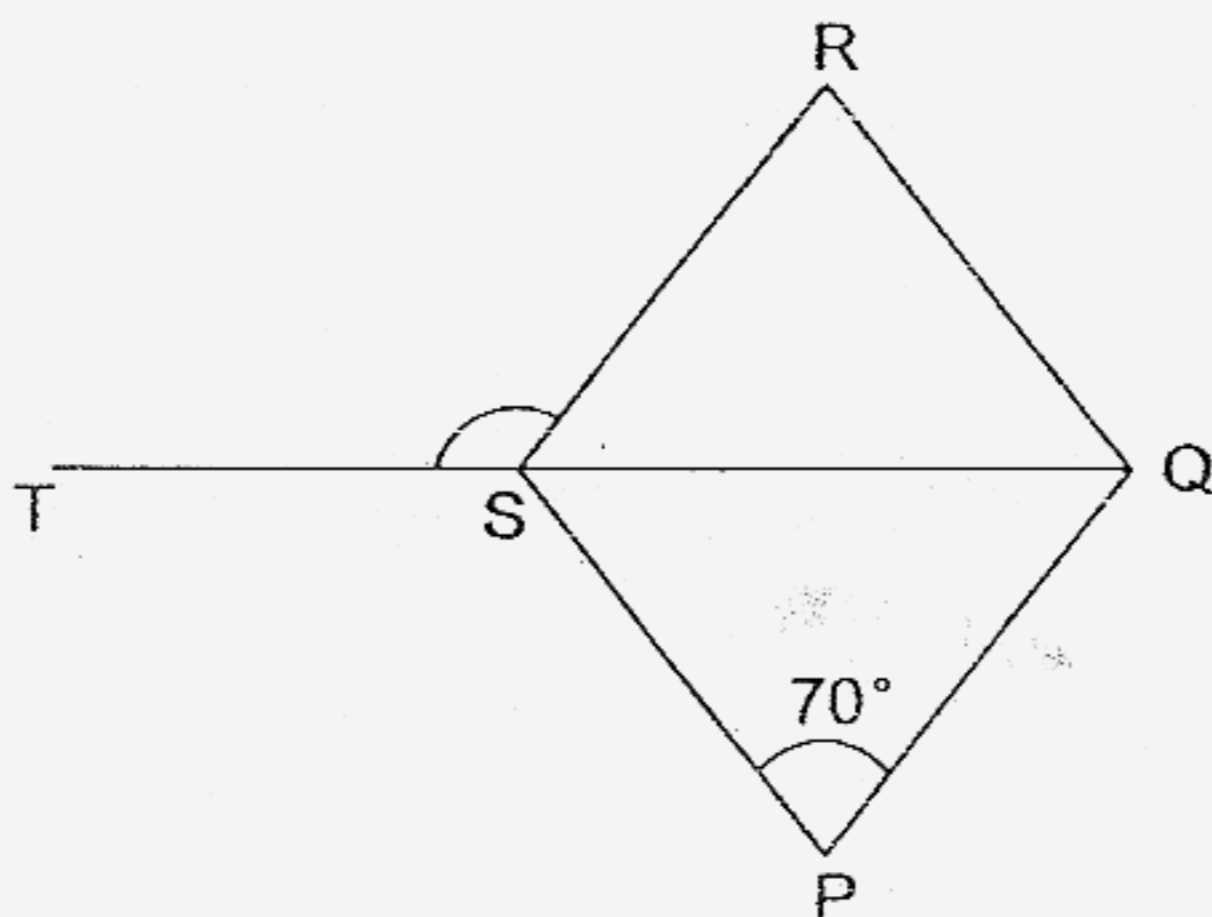

- (1)  $55^\circ$
- (2)  $70^\circ$
- (3)  $110^\circ$
- (4)  $125^\circ$

- 12 The average mass of 8 men is 73.9 kg. If the mass of another two men is 84.5 kg and 58.2 kg, what is the average mass of all the men?

- (1) 71.35 kg
- (2) 72.2 kg
- (3) 73.39 kg
- (4) 79.2 kg

- 13 The table below shows the rental charges for canoes.

Rental Charges	
First hour	\$ 14
Every additional $\frac{1}{2}$ h or part thereof	\$ 6.50

Royston rented a canoe from 10.15 a.m. to 1 p.m. How much did he pay?

- (1) \$ 27.00
- (2) \$ 36.75
- (3) \$ 40.00
- (4) \$ 41.00



14. The solid below is made up of 4-cm cubes. What is the volume of this solid?

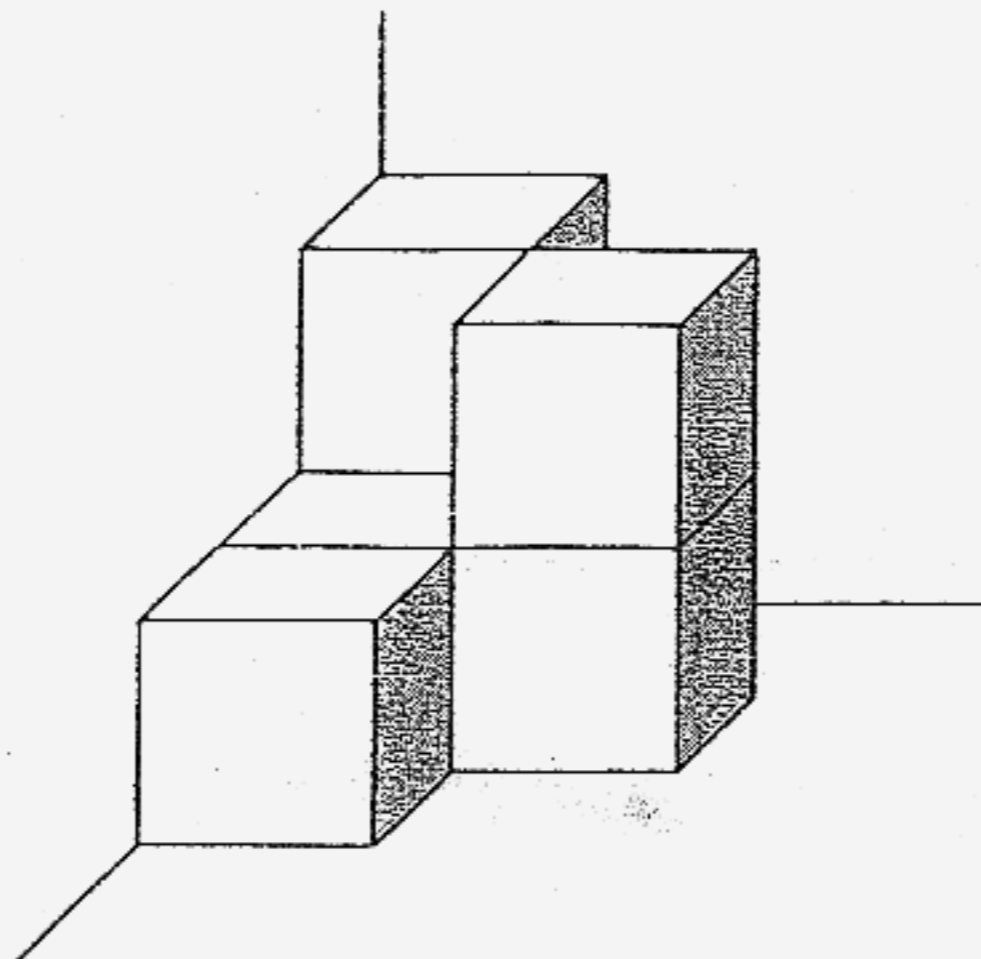

- (1)  $72 \text{ cm}^3$   
 (2)  $96 \text{ cm}^3$   
 (3)  $320 \text{ cm}^3$   
 (4)  $384 \text{ cm}^3$
- 15 Find the total of the number pattern below.

$$81 - 80 + 79 - 78 + 77 - 76 + \dots - 2 + 1.$$

What will be the digit in the tens place?

- (1) 1  
 (2) 8  
 (3) 3  
 (4) 4

Name: \_\_\_\_\_ ( ) Class: Pr 5 ( )

P5 SA2 2007

Booklet B

Questions 16 to 25 carry 1 mark each. Write your answers in the spaces provided. For questions which require units, give your answers in the units stated.

(10 marks)

16. 7 214 hundreds, 16 tens and 40 ones = \_\_\_\_\_ hundreds

Ans: \_\_\_\_\_

17 Fill in the box with the correct mathematical symbol (+, -, × or ÷) to make the statement below true.

$$25 \times 3 \quad \boxed{\phantom{000}} \quad 15 \div 5 + 7 = 85$$

Ans: \_\_\_\_\_

18 What is the missing number in the box?

$$40 : 16 = 25 : \boxed{\phantom{000}}$$

Ans: \_\_\_\_\_

19 Measure and write down the size of  $\angle CDB$ .

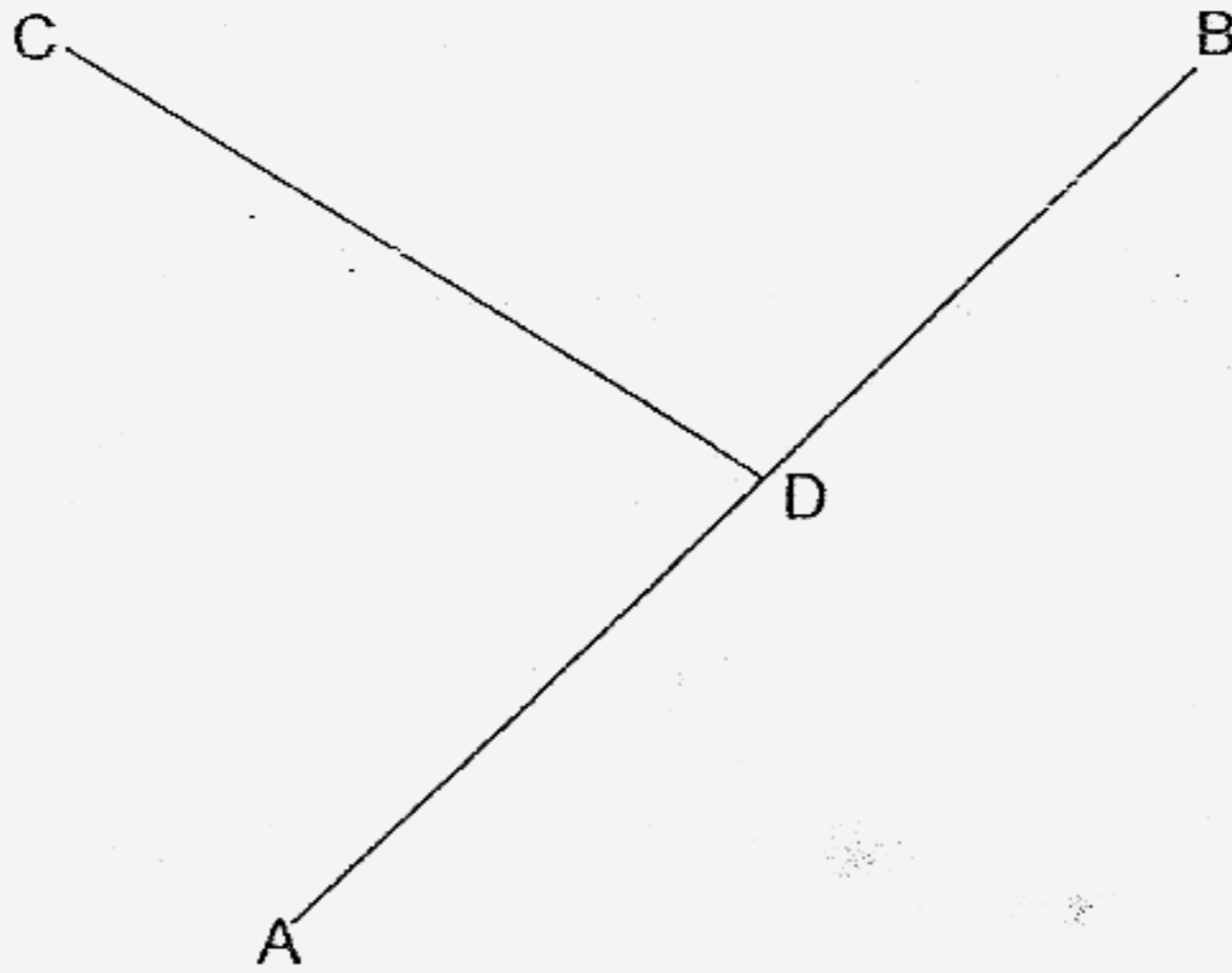

Ans: \_\_\_\_\_°

20 Muthu's luggage is 790 g heavier than Devi's luggage. If Muthu's luggage has a mass of 12.6 kg, what is the total mass of both their luggage?

Ans: \_\_\_\_\_ kg

21 A rectangular wall is 14.2 m by 8 m. If the cost of painting is \$3 per  $m^2$ , how much would it cost to paint the wall?

Ans: \$ \_\_\_\_\_

- 22 0.3 of the library books are Chinese books and the rest are English books. If there are 600 Chinese books, how many English books are there in the library?

Ans: \_\_\_\_\_

---

- 23 A bottle contains 300 ml of sparkling juice. Mrs Khoo needs 1.7 l of sparkling juice. How many bottles of sparkling juice does she need to buy?

Ans: \_\_\_\_\_

---

24. Which of the following shape (s) cannot be tessellated?

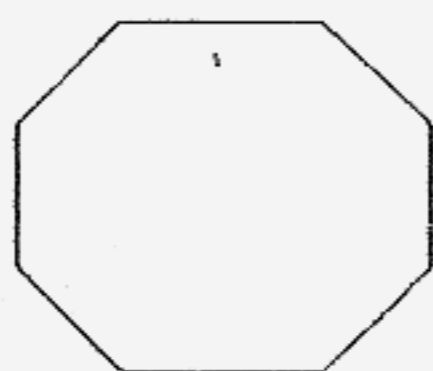

A

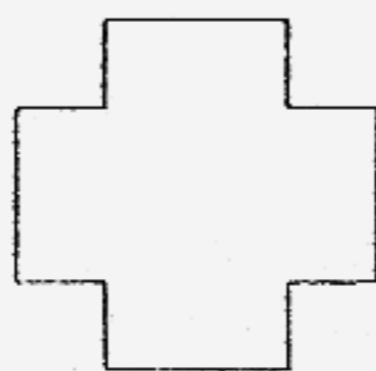

B

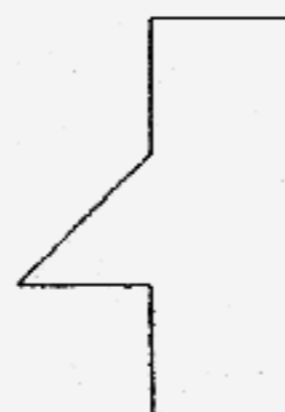

C

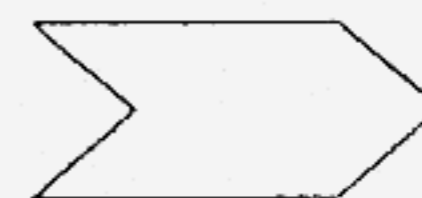

D

Ans: \_\_\_\_\_

---

25 The graph below shows the amount of money Grace spent during the one-week September holiday.

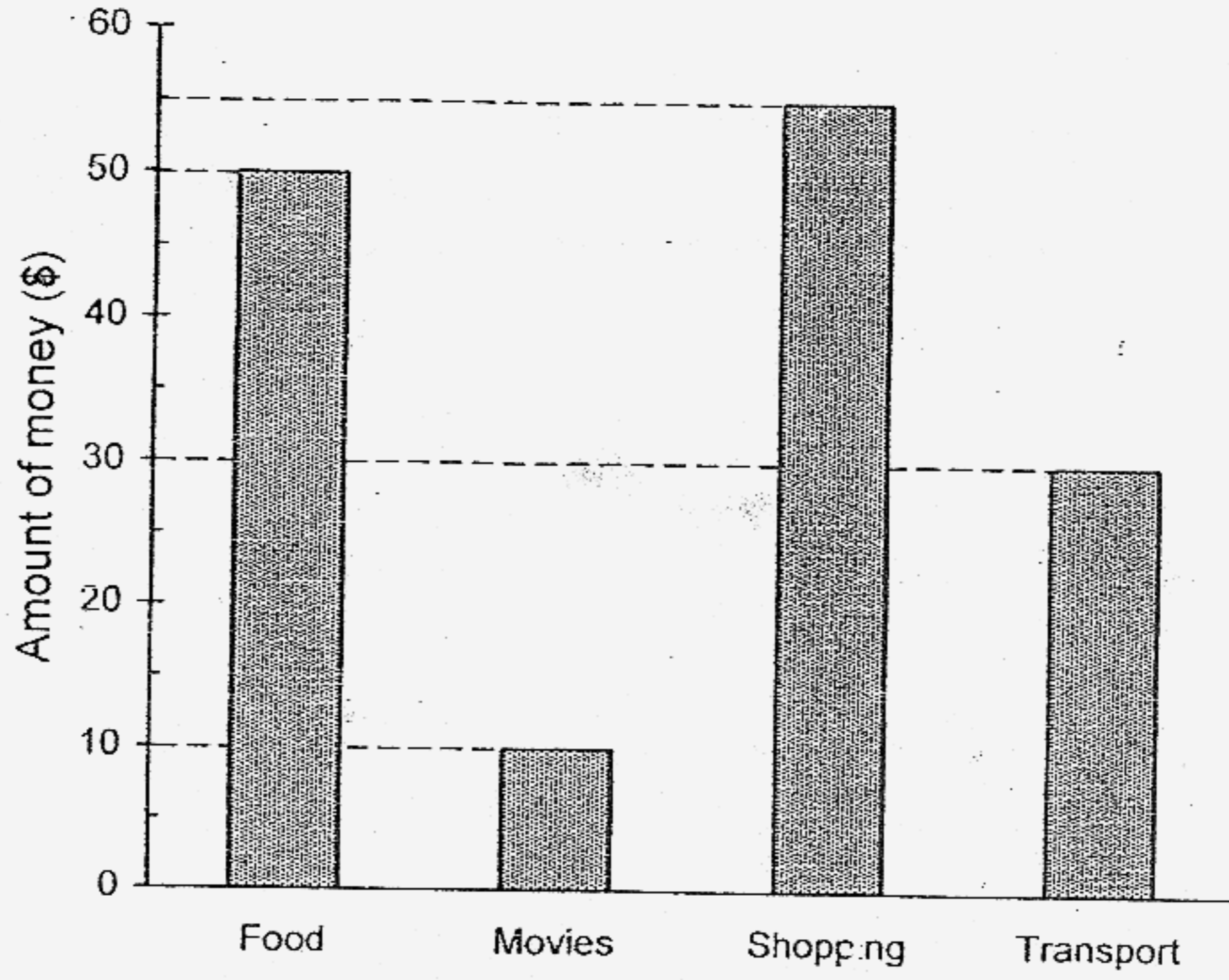

If Grace spent 58% of her weekly pocket money and saved the rest of the money, how much pocket money did she save?

Ans: \$ \_\_\_\_\_

Questions 26 to 35 carry 2 marks each. Show your working clearly in the space below each question and write your answers in the spaces provided. For questions which require units, give your answers in the units stated.

(20 marks)

- 
- 26 Andrew had \$268 and Brett had \$172 at first. Each of them bought a pair of skates at the same price. After their purchase, Andrew had five times as much money left as Brett. How much did each pair of skates

Ans. \_\_\_\_\_

- 27 Twice of a number is greater than  $\frac{3}{4}$  of the same number by 10. What is the number?

- 
- 28 Aisha has enough money to buy either 6 peaches or 12 apples. If she buys 8 apples, how many peaches can she buy with the remaining money?

Ans. \_\_\_\_\_

- 29 The figure shows a rectangle ABCD and a triangle CDE. Find the area of the shaded part.

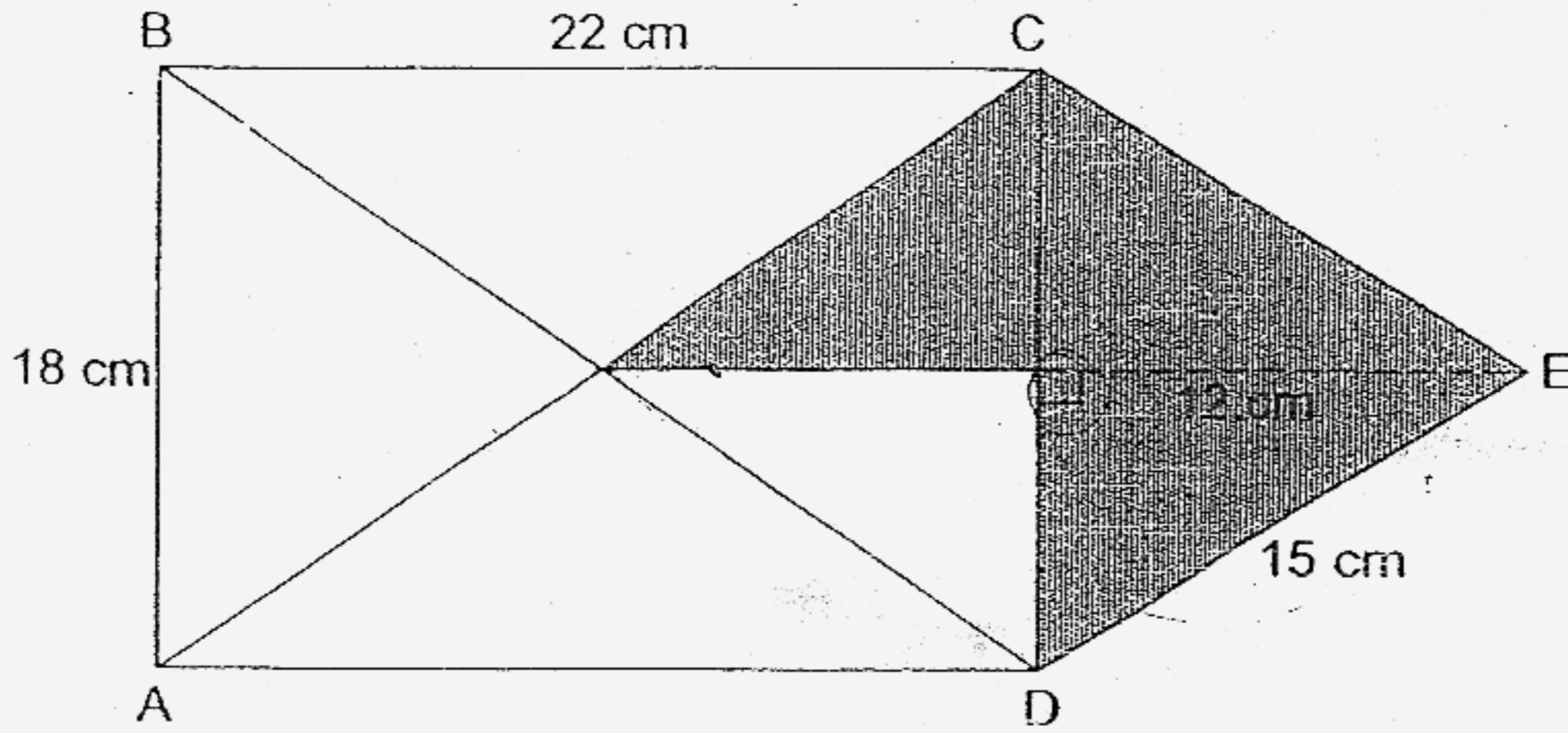

Ans: \_\_\_\_\_ cm<sup>2</sup>

- 30 Miss Tan had 10% fewer beads than Miss Yeo. After Miss Yeo gave 50% of her beads to Miss Tan, Miss Tan had 7000 beads. How many beads did Miss Yeo give Miss Tan?

Ans: \_\_\_\_\_

- 31 Every minute, Machine A prints 240 pages and Machine B prints 300 pages. What is the total number of pages that Machine A and Machine B can print in an hour?

Ans: \_\_\_\_\_

- 32 In the figure below, ABCD is a square and CDE is an equilateral triangle. Find  $\angle AFD$ .

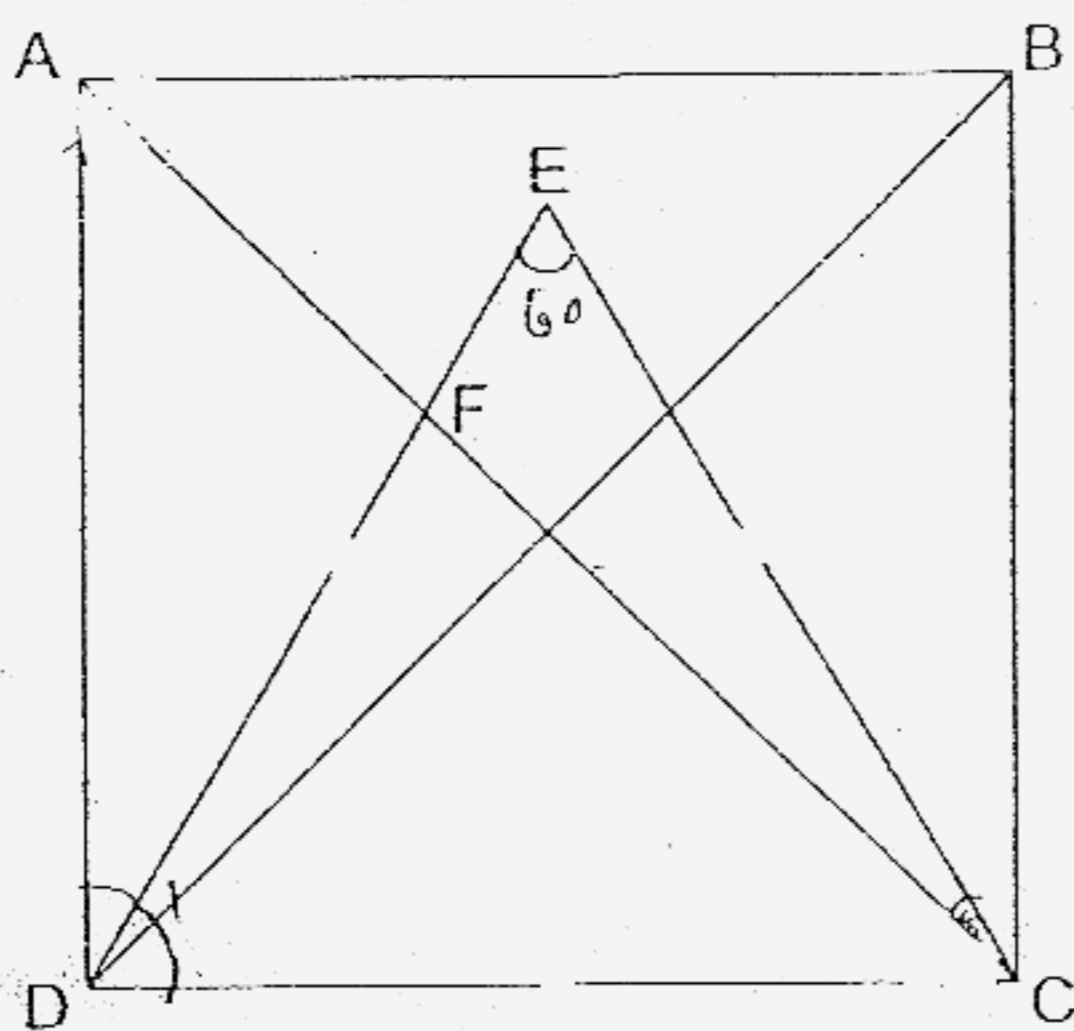

Ans: \_\_\_\_\_

- 33 What is the missing number in the number pattern below?

5

15                      14

19                                      76

56                                      ?

20

Ans: \_\_\_\_\_



- 34 Draw a parallelogram WXYZ in which  $\angle WXY = 65^\circ$  and  $WX = 6$  cm. The line XY has been drawn for you. Label your diagram clearly.

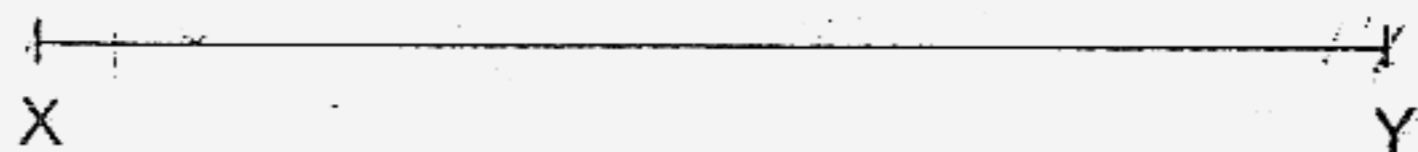

- 35 If all the 2-cm cubes as shown on the right are put into the box below, how many more of such 2-cm cubes need to be packed into the box to fill it to the brim?

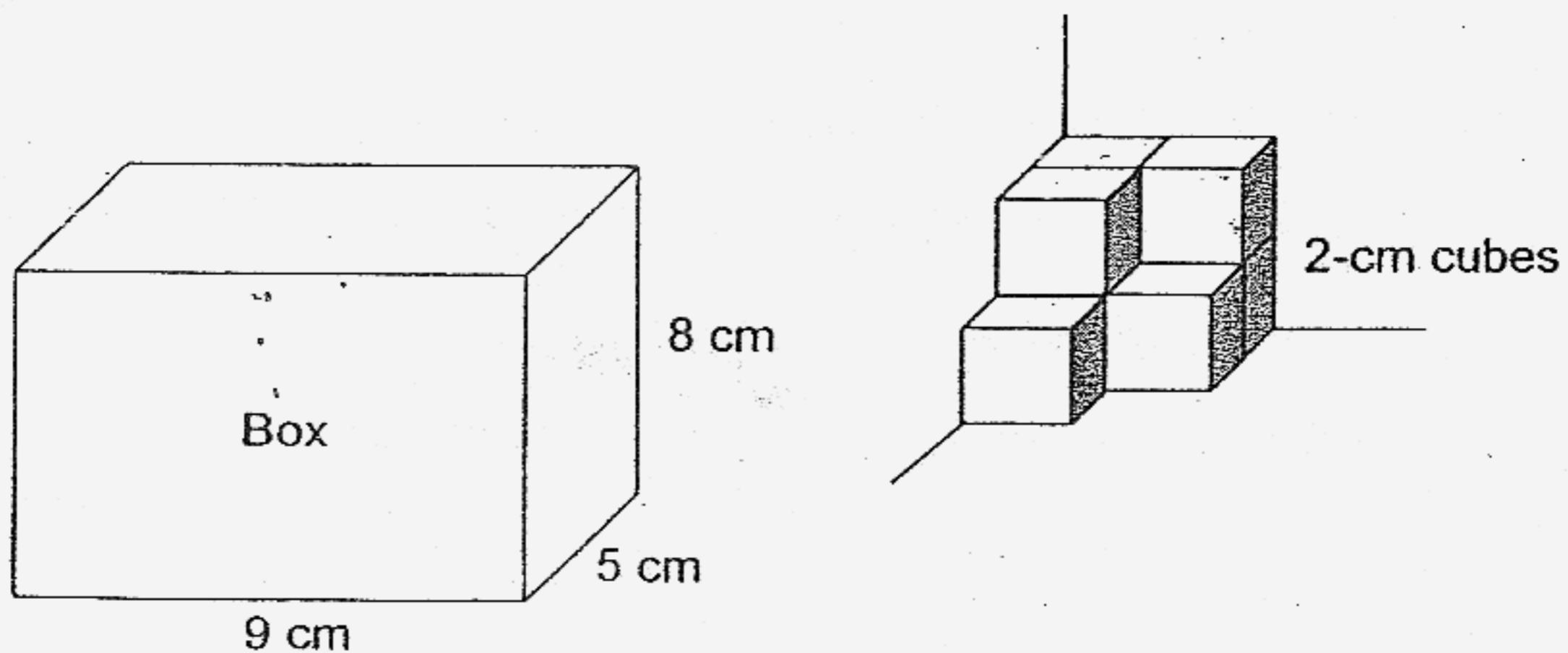

Ans: \_\_\_\_\_

Name: \_\_\_\_\_ ( ) Class: Pr 5 ( )

P5 SA2 2007

For questions 36 to 48, show your working clearly in the space provided for each question and write your answers in the spaces provided.

The number of marks available is shown in brackets [ ] at the end of each question or part-question.

(50 marks)

- 36** Some lamp posts were placed in a straight row at equal distances apart. The distance between the 1<sup>st</sup> and 6<sup>th</sup> lamp post was 85 m. The distance between the 2<sup>nd</sup> and the last lamp post was 187 m. How many lamp posts were there altogether?

Ans: \_\_\_\_\_ [3]

- 37** Margaret, Pete and Alvern shared the cost of a handbag for their mother.  $\frac{1}{3}$  of Margaret's share was equal to  $\frac{1}{2}$  of Pete's share.  $\frac{1}{2}$  of Pete's share was equal to  $\frac{3}{4}$  of Alvern's. If Margaret paid \$150 more than Alvern, how much did the handbag cost?

38 In the figure below, ABCD is a parallelogram and DEF is an equilateral triangle. CDE and DFG are straight lines.

- (a) Find  $\angle x$ .
- (b) What is the ratio of  $\angle x$  to  $\angle y$ ?

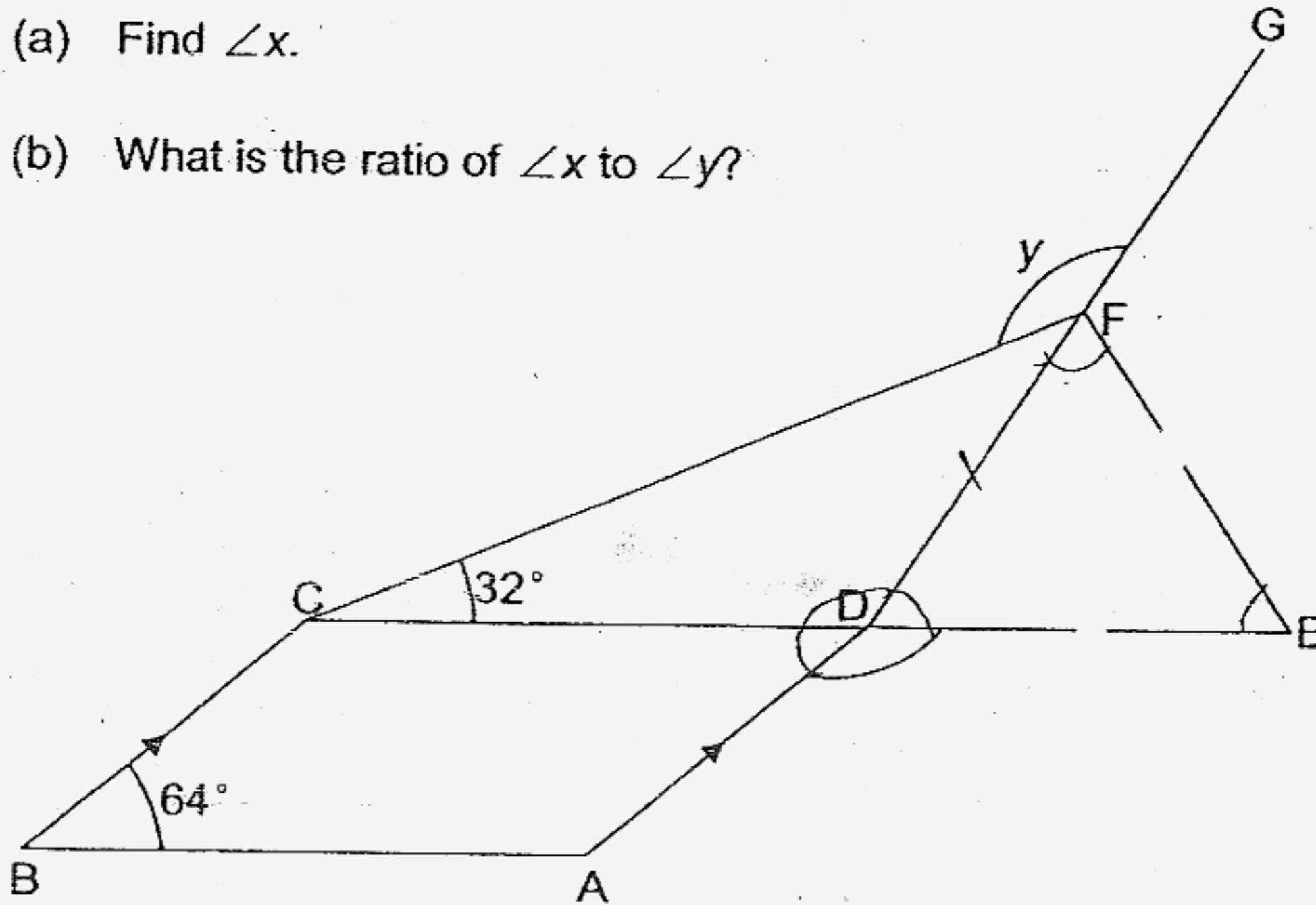

Ans: (a) \_\_\_\_\_ [1]

(b) \_\_\_\_\_ [2]

39 Helen jogged a distance of 1000 m. on Monday. Everyday she increased the distance she jogged the previous day by 10%. What was the total distance she would have jogged on Thursday? Give your answer to the nearest kilometre.

Ans: \_\_\_\_\_ [3]

40. In the figure below, ABCD is a parallelogram and  $AB \parallel EF$ .

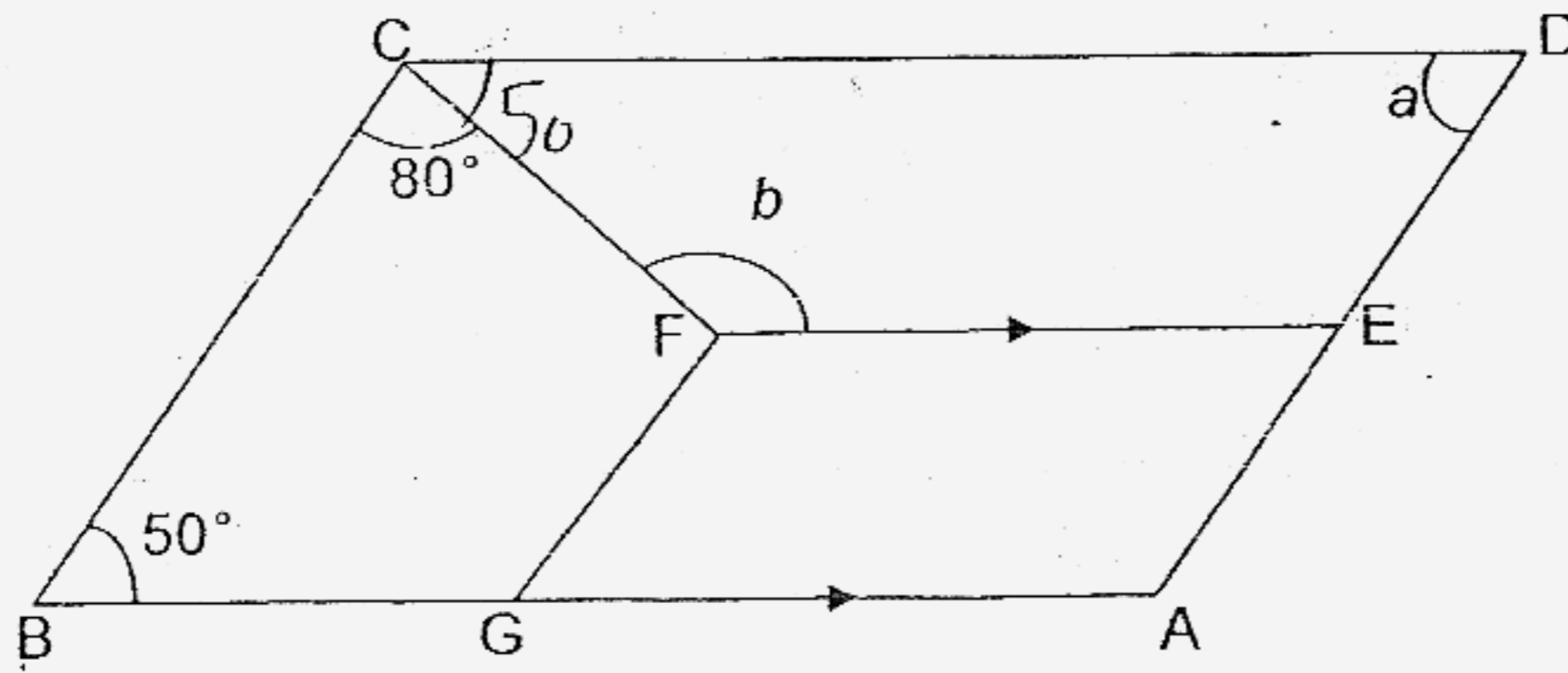

(a) Find  $\angle a$ .

(b) Find  $\angle b$ .

Ans: (a) \_\_\_\_\_ [1]

(b) \_\_\_\_\_ [2]

41 ABC and BDE are isosceles triangles. BCF is a straight line. Find  $\angle ACE$ .

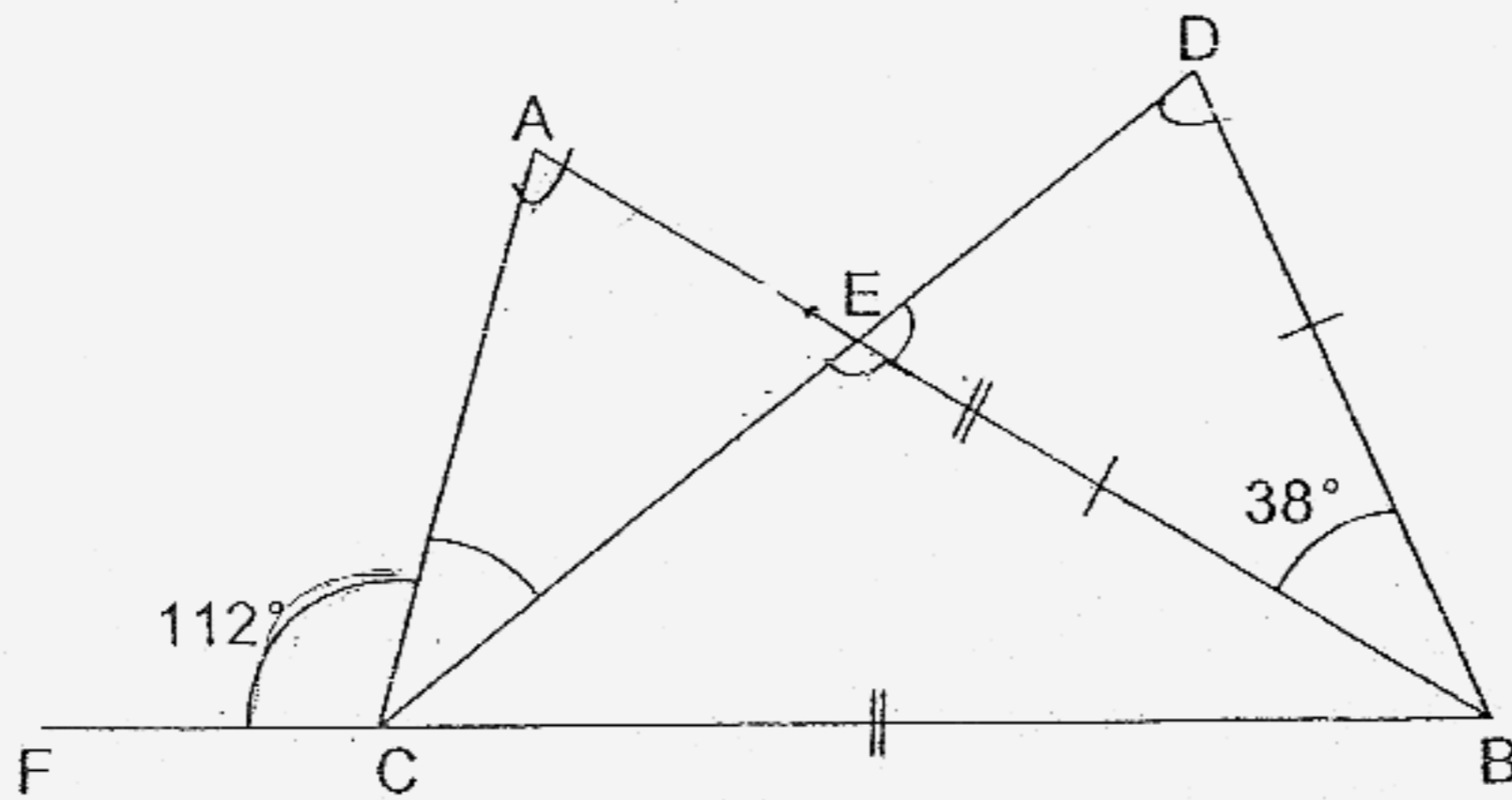

Ans: \_\_\_\_\_ [3]

- 42 A piece of rectangular paper measuring 15 cm by 10 cm is folded along the dotted line AB to form the figure on the right. It was then folded along the dotted line CD. Find the area of the remaining paper after it was folded along AB and CD.

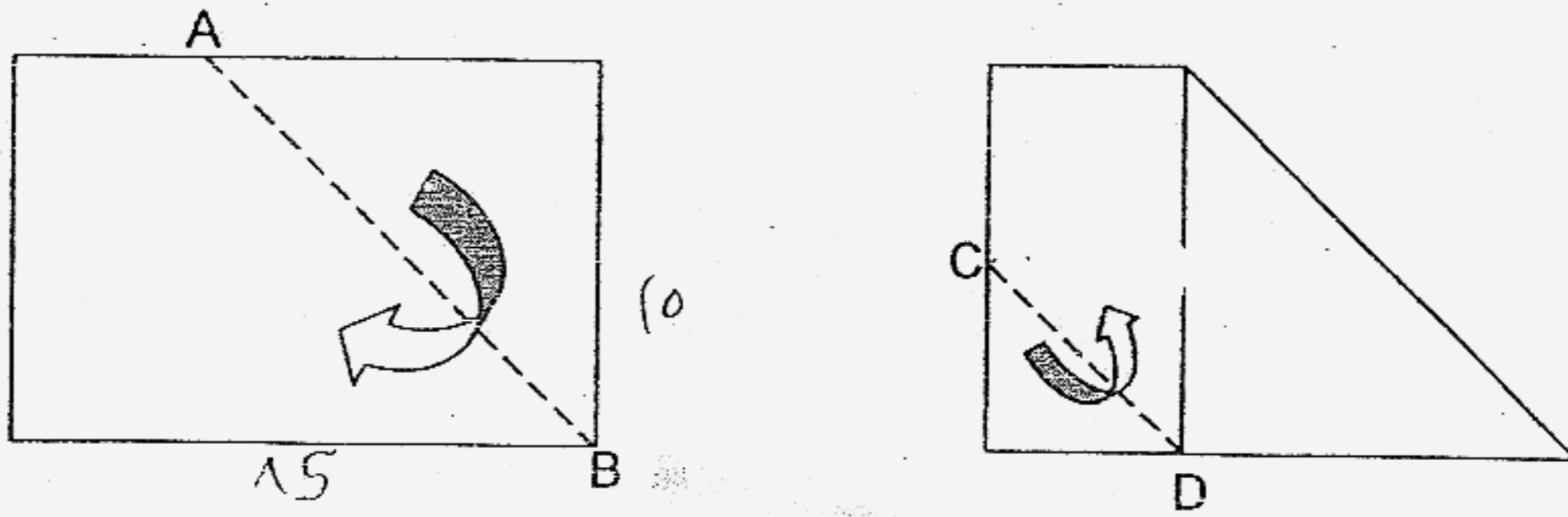

Ans: \_\_\_\_\_ [4]

- 43 Amy, Beatrice, Catherine and Dawn had an average of 56 dresses. Amy had 45 dresses. The total number of dresses that Beatrice and Catherine had was 13 more than the number of dresses that Dawn had. What was the average number of dresses that Amy, Beatrice and Catherine had?

Ans: \_\_\_\_\_ [4]

---

- 44 The graph below shows the number of Primary 1 to Primary 6 pupils who had completed their online assignments during the September holiday.

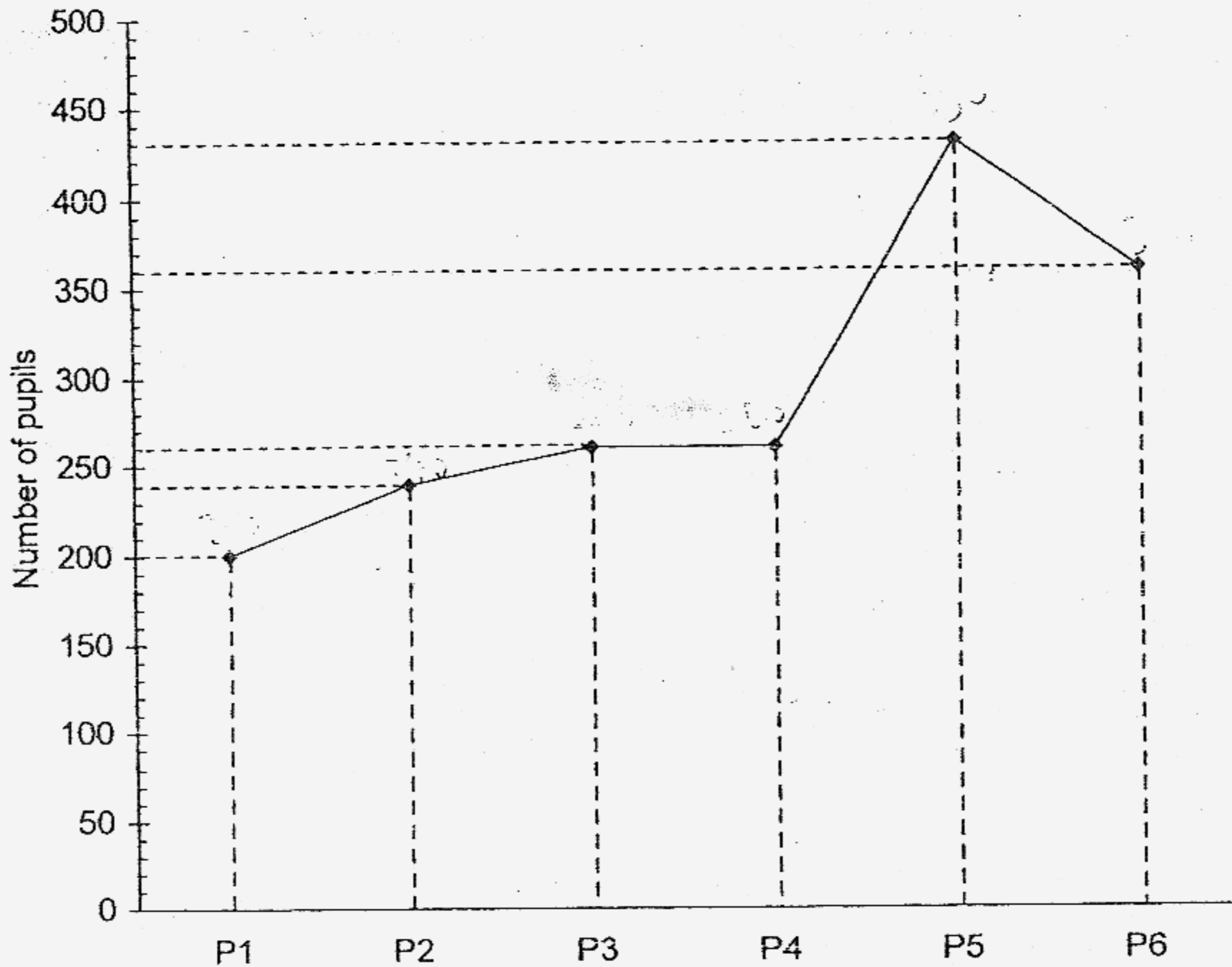

- (a) How many pupils completed their assignments altogether?
- (b) If only 40% of the total school population completed their online assignments, what percentage of the pupils who completed their online assignments were P1 to P3 pupils?

Ans: (a) \_\_\_\_\_ [1]

(b) \_\_\_\_\_ [3]

- 45 A tank measuring 60 cm by 40 cm by 30 cm was empty at first. Water from a tap started to fill the tank at a rate of 2 l per minute. After the water level had reached  $\frac{5}{6}$  of the height of the tank, water began to leak from a crack at the base of the tank at a rate of 400 ml per minute. What was the total time taken for the whole tank to be completely filled?

Ans :



46 Ada, Becky and Cathy had some stamps. Cathy had 20% more stamps than Ada. Cathy had 75% as many stamps as Becky. Becky gave 45 stamps to Ada and Cathy in the ratio of 4 : 1 so that all three girls will have the same number of stamps.

- (a) How many stamps did Becky have at first?
- (b) What percentage of the stamps did Cathy have at first?

Ans: (a)

(b) \_\_\_\_\_

47 For every 5 roses in a florist shop, there were 3 tulips. For every 9 carnations in the florist shop, there were 4 tulips.

(a) Find the ratio of the number of carnations to the number of roses to the number of tulips in the shop.

(b) After 21 roses were sold,  $\frac{1}{4}$  of the remaining flowers were roses. How many more carnations than tulips were there in the shop?

Ans: (a) \_\_\_\_\_ [1]

(b) \_\_\_\_\_ [4]

- 48 Three schools, School A, School B and School C participated in the Racial Harmony Games Day. There were 68 representatives from Schools B and C. If 32 representatives were not from School B and 44 representatives were not from School C, what was the total number of representatives from the three schools?

Ans: \_\_\_\_\_ [5]

---

**END OF PAPER**

Setters: Ms Elaine Ho  
Mdm Denise Jung

Nanyang Primary School  
 Primary 5 Maths SA2 Exam (2007)

*Answer Keys*

Q1	Q2	Q3	Q4	Q5
3	3	2	1	3
Q6	Q7	Q8	Q9	Q10
3	4	4	2	4
Q11	Q12	Q13	Q14	Q15
4	3	3	4	2

16. 7216

18. 10

20. 24.4kg

22. 1400

24. A

26. \$148

28. 2

30. 2500

32. 105°

34. 1100  
(1)

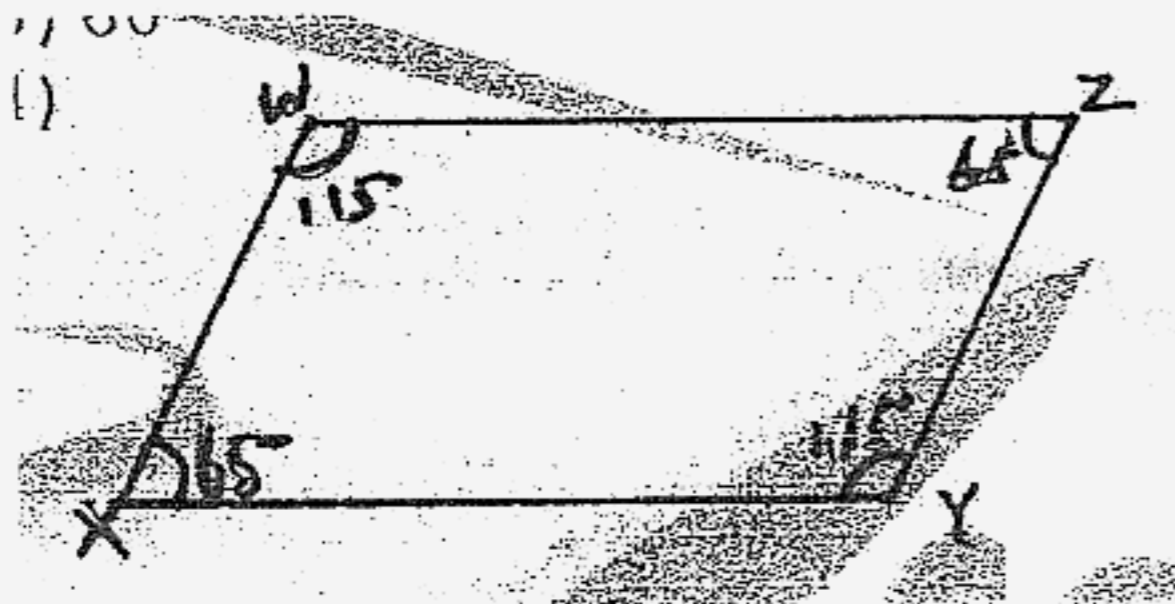

17. +

19. 105°

21. \$340.80

23. 6

25. \$105

27. 8

29.  $157\frac{1}{2} \text{ cm}^2$

31. 32400

33. 60

35. 24

36.  $85 \div 5 = 17$   
 $17 \times 4 = 68$   
 $187 - 68 = 119$   
 $119 \div 17 = 7$   
 $6 + 7 = 13$

37.  $3 \times 3 = 9$   
 $9 - 4 = 5$   
 $150 \div 5 = 30$   
 $30 = 1 \text{ unit}$   
 $4 + 6 + 9 = 19$   
 $30 \times 19 = \$570$

38a.  $180^\circ \div 3 = 60^\circ$   
 $60^\circ + 32^\circ = 92^\circ$   
 $180^\circ - 92^\circ = 88^\circ$   
 $88^\circ - 60^\circ = 28^\circ$   
 $28^\circ + 32^\circ = 60^\circ$   
 $180^\circ - 60^\circ = 120^\circ$   
 $60^\circ + 64^\circ + 120^\circ = 244^\circ$   
 $360^\circ - 244^\circ = 116^\circ$

38b.  $180^\circ - 28^\circ = 152^\circ$   
 $116 : 152$   
 $58 : 76$   
 $29 : 38$

39.  $1000 = 1\text{km}$   
 $1000 \div 10\% = 100$   
 $1000 + 100 = 1100$   
 $1000 + 1100 = 2100$   
 $2100 + 1200 = 3300$   
 $3300 + 1300 = 4600$   
 $4600 \approx 5\text{km}$

40a.  $180^\circ - 50^\circ = 130^\circ$   
 $180^\circ - 130^\circ = 50^\circ$

40b.  $50^\circ \times 2 = 100^\circ$   
 $360^\circ - 100^\circ = 260^\circ$   
 $260^\circ \div 2 = 130^\circ$   
 $130^\circ - 80^\circ = 50^\circ$   
 $180^\circ - 50^\circ = 130^\circ$

41.  $180^\circ - 38^\circ = 142^\circ$   
 $142^\circ \div 2 = 71^\circ$   
 $180^\circ - 112^\circ = 68^\circ$   
 $68^\circ + 71^\circ = 139^\circ$   
 $180^\circ - 139^\circ = 41^\circ$

42.  $15 \times 10 = 150$   
 $\frac{1}{2} \times 10 \times 10 = 50$   
 $150 - 50 = 100$   
 $\frac{1}{2} \times 5 \times 5 = 12.5$   
 $100 - 12.5 = 87.5\text{cm}^2$

43.  $X = \text{Catherine}$   
 $Y = \text{Beatrice}$   
 $X + Y = 13 \text{ (Dawn)}$

$56 \times 4 = 224$   
 $224 - 45 = 179$

$X + Y + X + Y - 13 = 179$   
 $2X + 2Y - 13 = 179$   
 $2X + 2Y = 179 + 13$   
 $2X + 2Y = 192$   
 $X + Y = 96$

$\text{Catherine} + \text{Beatrice} = 96$   
 $96 + 45 = 141$   
 $141 \div 3 = 47$

44a.  $200 + 240 + 260 + 260 + 430 + 360 = 1750$

44b.  $200 + 240 + 260 = 700$

$\frac{700}{1750} \times 100 = 40\%$

45. 37.5 mins

46a. 216

47a. 27 : 20 : 12

46.  $31\frac{11}{19}$

47b. 45

48. 72