



AI TONG SCHOOL

2007

SEMESTRAL ASSESSMENT 2

PRIMARY 5

MATHEMATICS

DURATION : 2 h 15 min

DATE : 25 OCT 2007

INSTRUCTIONS

Do not open the booklet until you are told to do so.
Follow all instructions.
Answer all questions.

Name _____ ()

Class : Primary 5 _____

Marks:

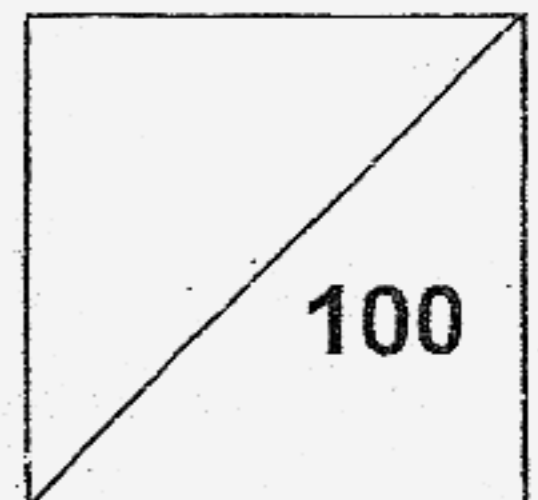

Parent's Signature	:	_____
Date	:	_____

Booklet A

Questions 1 to 10 carry 1 mark each. Questions 11 to 15 carry 2 marks each.

For each question, four options are given. One of them is the correct answer.

Make your choice (1, 2, 3 or 4). Shade the oval (1, 2, 3 or 4) on the Optical Answer Sheet.

(20 marks)

1. Which one of the following is the best estimate for 85×573 ?

- (1) 80×500
- (2) 80×600
- (3) 90×500
- (4) 90×600

2. What is the quotient when 3267 is divided by 16?

- (1) 24
- (2) 54
- (3) 204
- (4) 544

3. Marie had $\frac{7}{10}$ m of wire. She cut it into 5 equal pieces. What was the length of each piece of wire?

- (1) $\frac{7}{50}$ m
- (2) $\frac{2}{7}$ m
- (3) $3\frac{1}{2}$ m
- (4) $5\frac{7}{10}$ m

85

4. Express 6 months as a fraction of 2 years.

(1) $\frac{1}{6}$

(2) $\frac{1}{4}$

(3) $\frac{1}{3}$

(4) $\frac{1}{2}$

5. The value of $\frac{5}{100} + \frac{1}{10} + \frac{6}{1000}$ to the nearest hundredth is _____.

(1) 0.01

(2) 0.16

(3) 0.012

(4) 0.156

6. There are 40 pupils in Class 5A. 18 of the pupils wear spectacles. What percentage of the pupils in Class 5A does not wear spectacles?

(1) 9%

(2) 45%

(3) 55%

(4) 82%

7. Jack and his cousin had 465 marbles each. Jenny had 330 marbles while her sister had none. Find the average number of marbles of the children.

(1) 265

(2) 315

(3) 398

(4) 420

8. Mr Vellu had to take a pill 4 times a day. He had a bottle containing 196 pills. How many weeks would he take to finish all the pills?

- (1) 7
- (2) 49
- (3) 112
- (4) 784

9. In the figure not drawn to scale, ABD is an equilateral triangle. ABC is a straight line and $BC = BD$. Find $\angle BDC$.

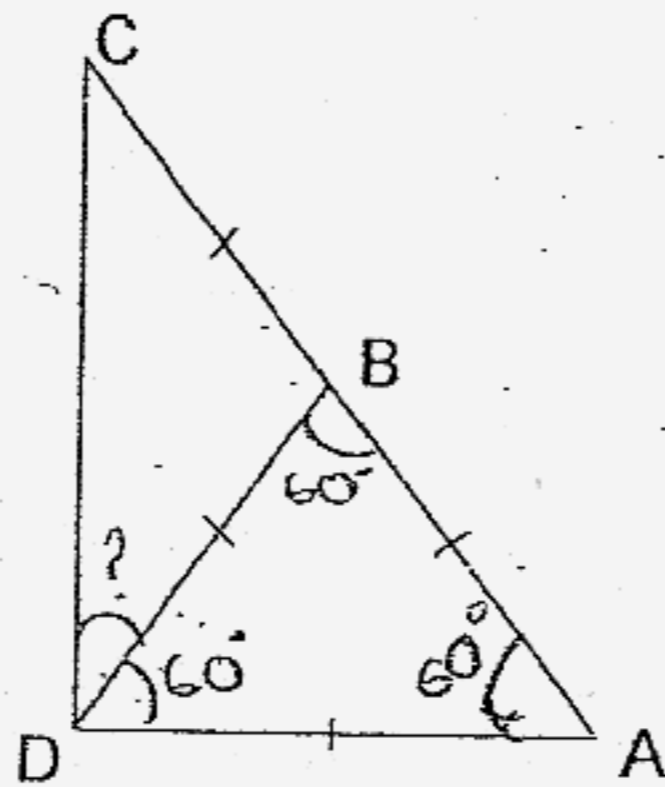

- (1) 15°
- (2) 30°
- (3) 60°
- (4) 120°

10. The volume of a 8 cm cube is _____.

- (1) 24 cm³
- (2) 64 cm³
- (3) 192 cm³
- (4) 512 cm³

11. 2 similar watches cost \$33 less than 3 similar pens. If the pens cost \$45 each, find the cost of each watch.

- (1) \$6
- (2) \$39
- (3) \$51
- (4) \$84

87

12. Danny spent $\frac{2}{5}$ of his money on a bag and $\frac{1}{3}$ of the remainder on some snacks. What percentage of his money had he left?

- (1) 13%
 (2) 20%
 (3) 40%
 (4) 60%

13. There were 780 people in a cinema. After $\frac{1}{2}$ of the women and 150 men left the cinema, the ratio of the number of men to that of women became 1 : 3. Find the number of men in the cinema at first.

- (1) 90
 (2) 240
 (3) 270
 (4) 336

14. The figure below is not drawn to scale. What percentage of the figure is shaded?

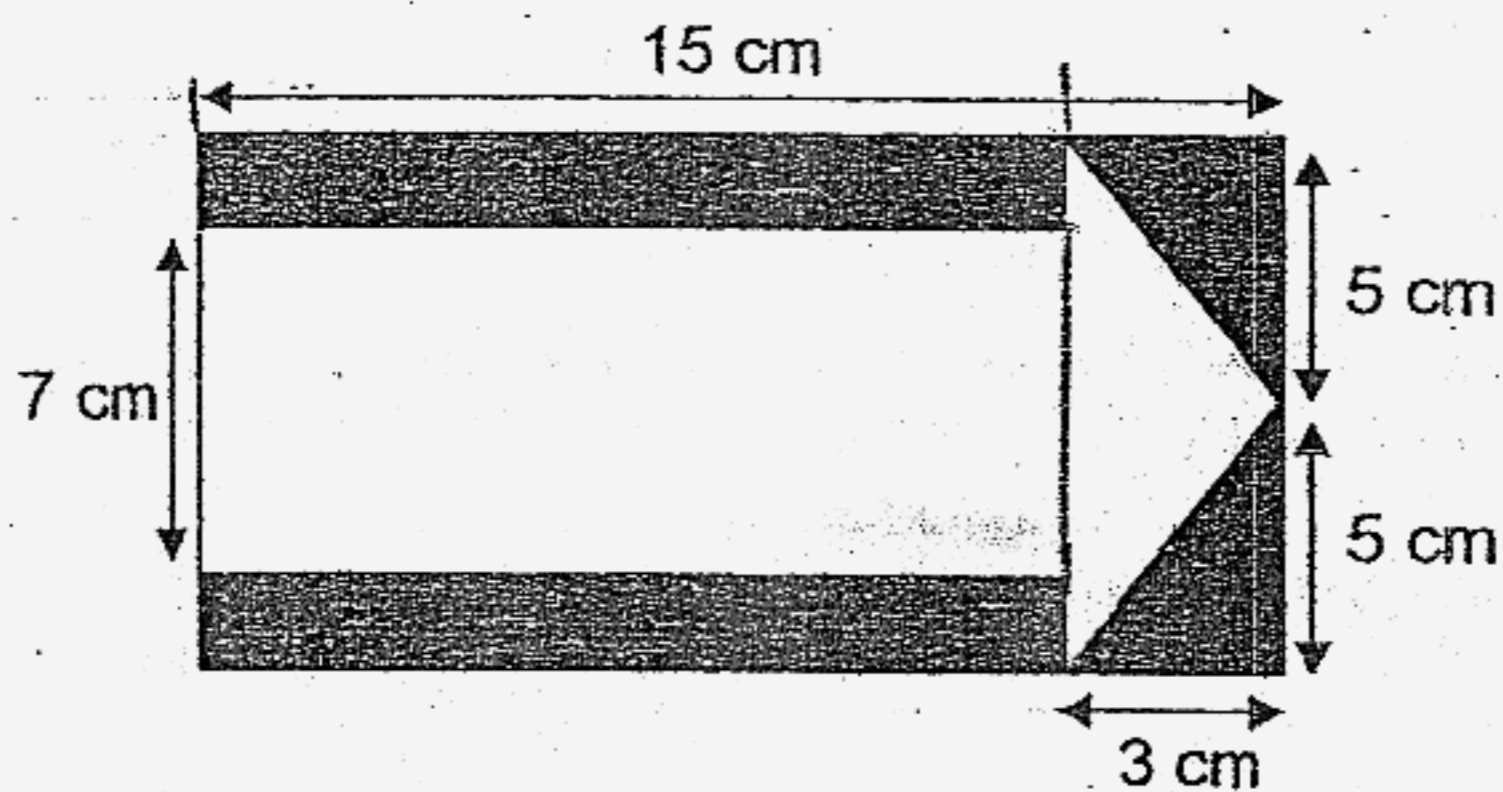

- (1) 24%
 (2) 34%
 (3) 51%
 (4) 66%

15. The bar graph below shows the monthly sales of handbags in a shop.

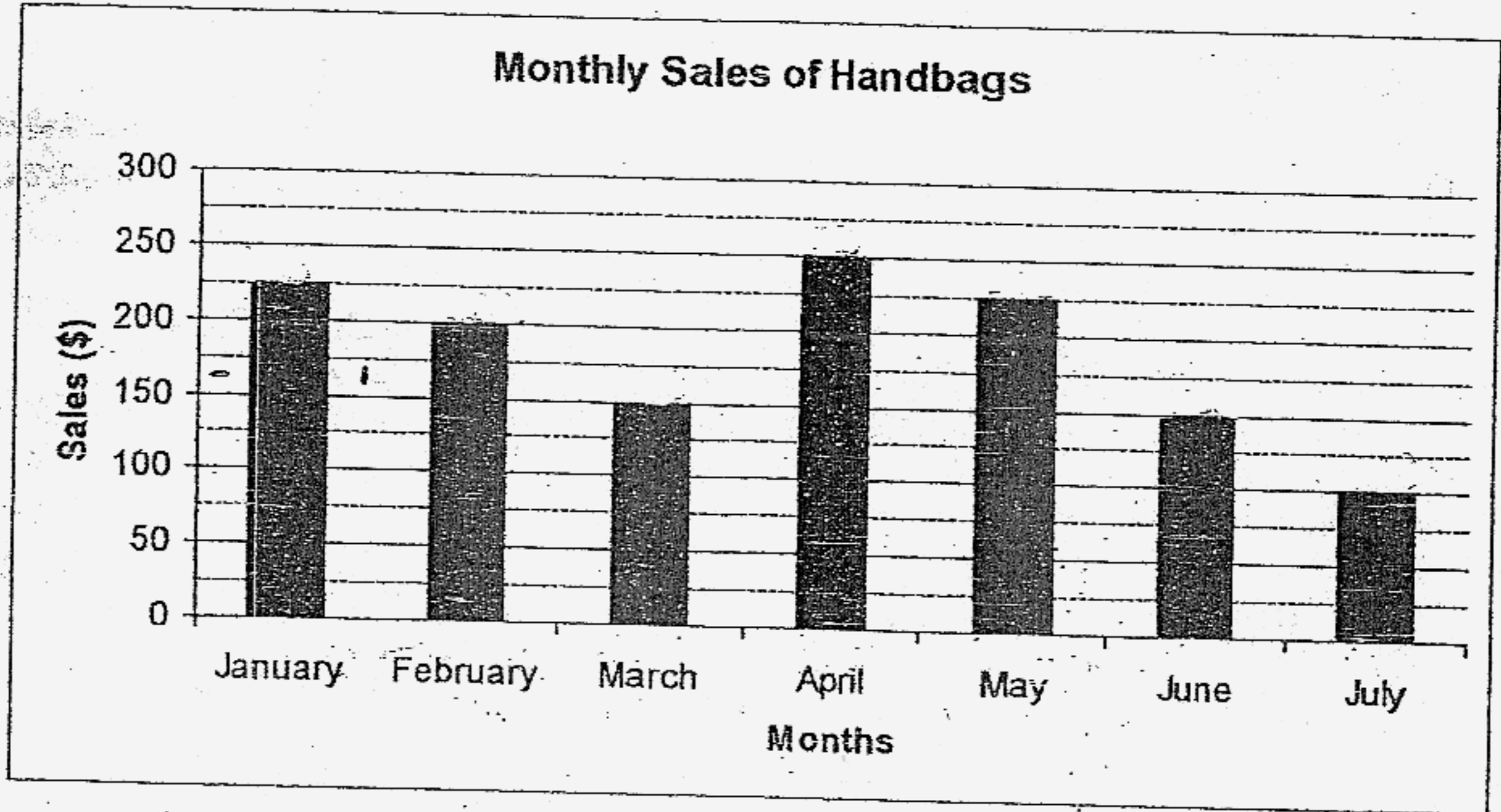

In which month was the decrease in sales of handbags the greatest as compared with the previous month?

- (1) March
- (2) April
- (3) May
- (4) June

Name: _____ ()

Class: Primary 5 _____

Booklet B**Questions 16 to 25 carry 1 mark each.****Questions 26 to 35 carry 2 marks each.**

Show your working clearly in the space below each question and write your answers on the blanks provided. For questions which require units, give your answers in the units stated.

(30 marks)

16. In 542.603, which digit is in the tenths place?

Ans: _____

17. Find the value of 567×28

Ans: _____

18. Evaluate $7\frac{1}{8} - \frac{1}{4}$

Ans: _____

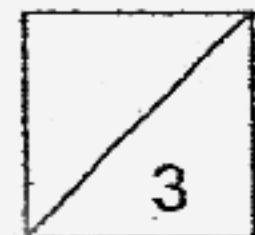

19. At a party, the ratio of the number of parents to boys was 7 : 4. The ratio of the number of boys to the number of girls was 2 : 5. Find the ratio of the number of parents to the number of girls. Express your answer in the simplest form.

Ans: _____

20. Using a protractor, measure $\angle x$ in the figure below.

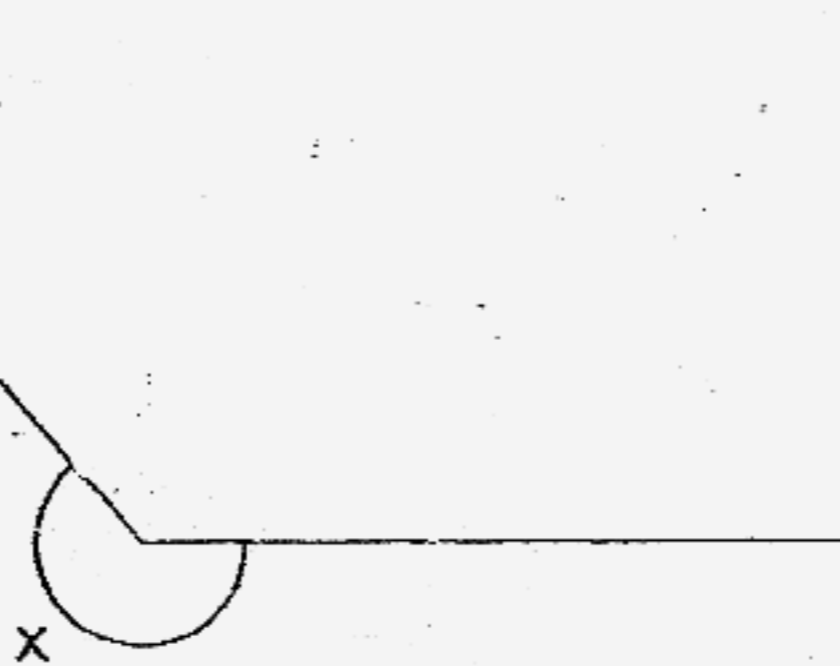

Ans: _____

21. 10 exercise books weigh as heavy as 3 workbooks. If each exercise book weighs 41.4 g, find the mass of 1 workbook.

Ans: _____ g

22. 140% of a number is 84. Find the number.

Ans: _____

23. The total cost of 5 blue dresses is \$128 and 3 red dresses cost \$48 each. What is the average cost of the 8 dresses?

Ans: \$ _____

24. When the metal ball is taken out from the container below, the water level drops from 20 cm to 11 cm. Find the volume of the metal ball.

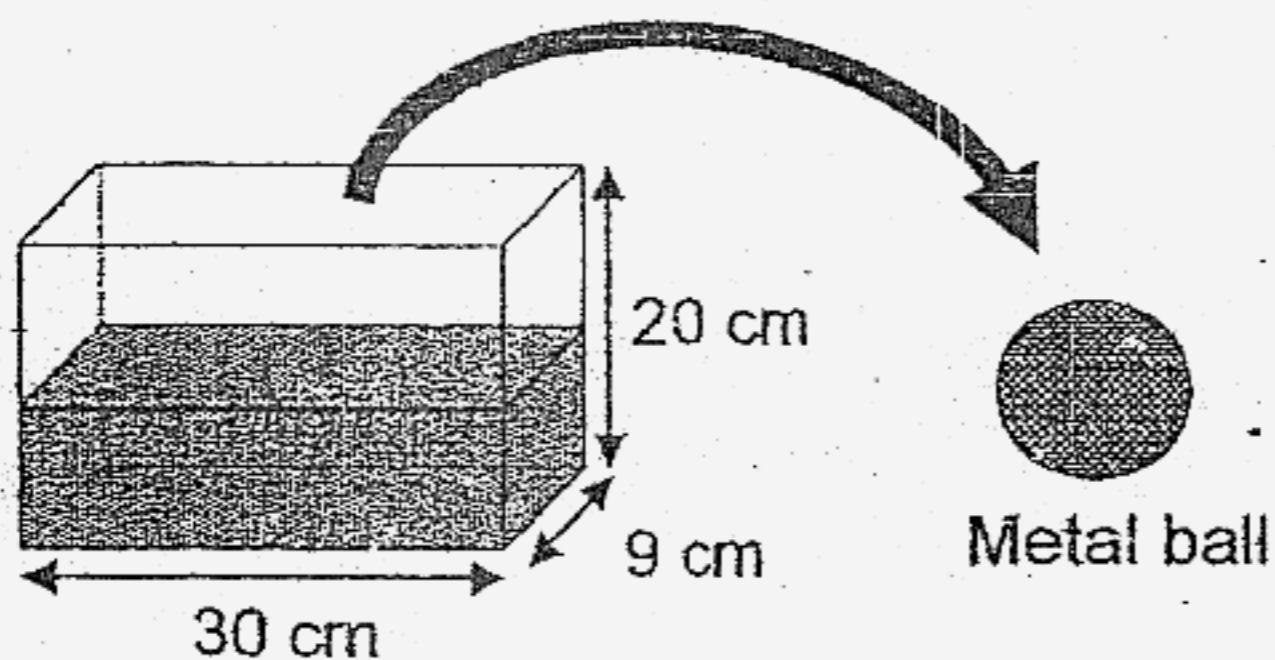

Ans: _____ cm^3

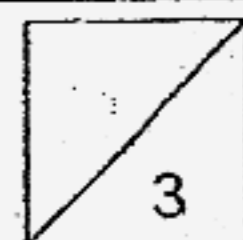

25. A bus driver earns \$3618 in 3 months. At this rate, how much will he earn in 2 years?

Ans: \$ _____

26. Find the value of

$$20 + 19 + 18 + 17 + 16 - 15 - 14 - 13 - 12 - 11 + 10 + 9 + 8 + 7 + 6 - 5 - 4 - 3 - 2 - 1 + 0.$$

Ans: _____

27. Diana, Linda and Eve shared 450 sweets. If each of them received 54 more sweets, the new ratio of the number of sweets shared by Diana, Linda and Eve would be 3 : 5 : 4. How many sweets did Diana have at first?

93

Ans: _____

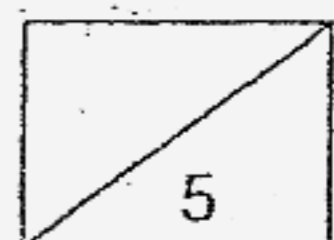

28. The figure below is not drawn to scale. The perimeter of the figure is 54 m. Find the shaded area.

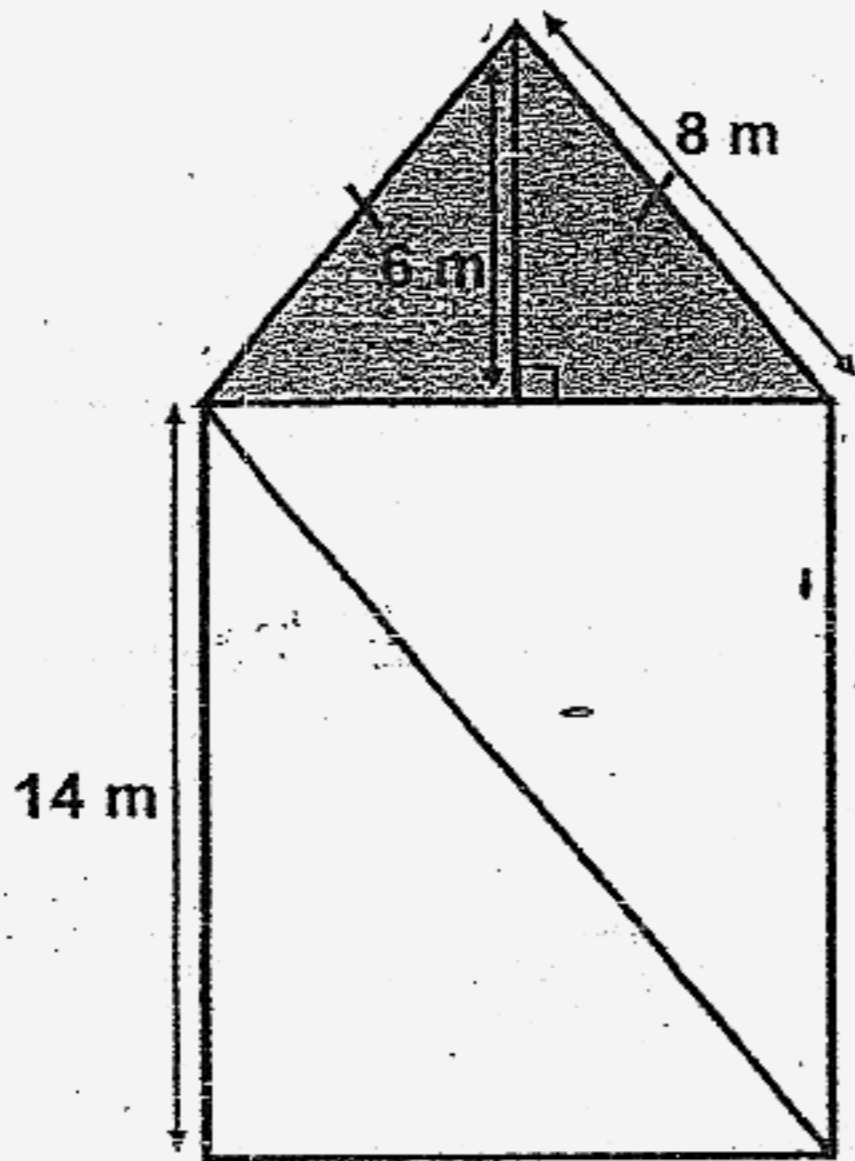

Ans: _____ m²

29. A car travelled 120 km on 10 l petrol. If the car were to travel 1260 km, beginning with a full tank, how many times must the driver top-up the fuel tank, given that the capacity of the tank is 50 l?

Ans: _____

94

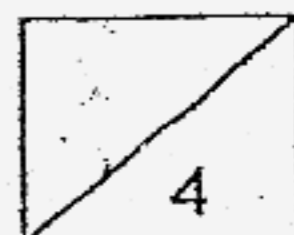

30. Mrs Lim can type 97 words in one minute. At the same rate, how many words can she type from 1 p.m. to 3.45 p.m.?

Ans: _____

31. The cuboid below has a square face of area 64 cm^2 . The length is $\frac{2}{5}$ its height. Find the volume of the cuboid.

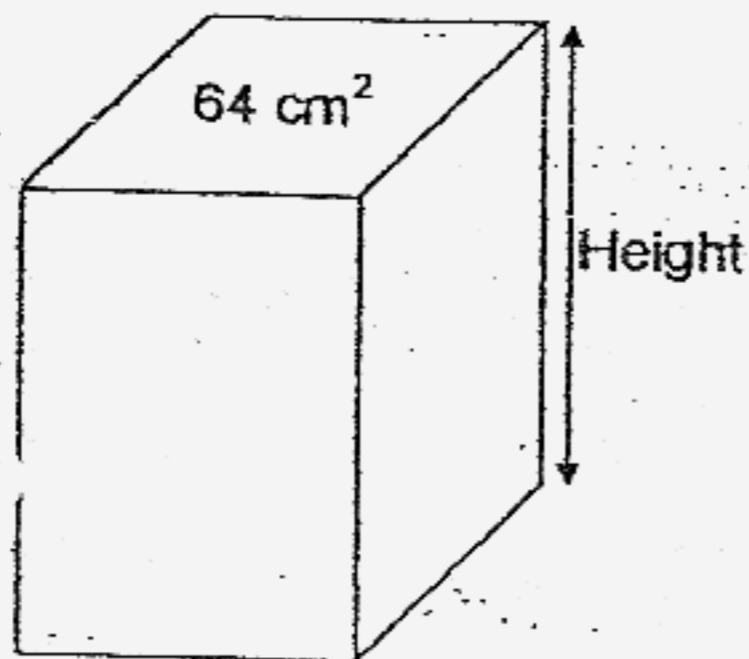

Ans: _____ cm^3

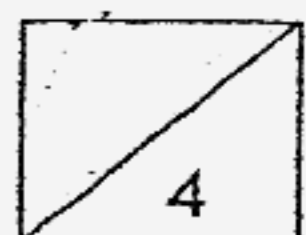

32. The figure below is not drawn to scale. Figure ABCD is a parallelogram. Find $\angle y$.

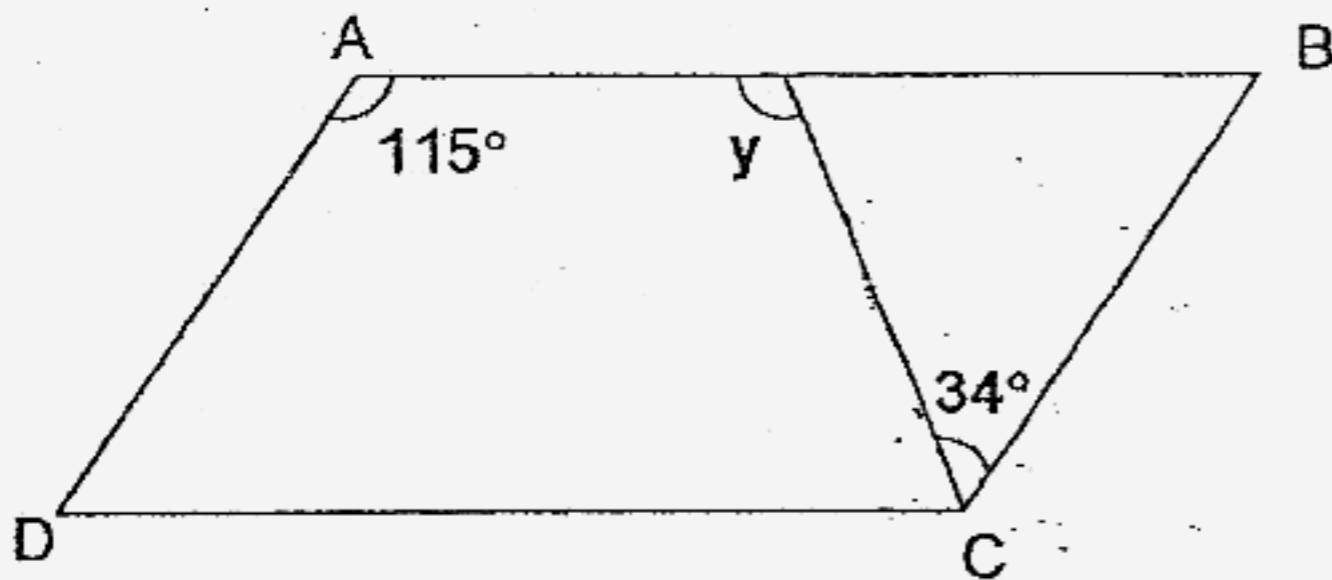

Ans: _____

33. 40% of the erasers in a box are purple. The rest are blue and green erasers in the ratio of 11: 4. There are 48 fewer purple erasers than blue erasers. How many erasers are there altogether?

Ans: _____

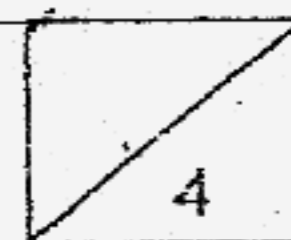

96

34. The figure below is not drawn to scale. QRS is an equilateral triangle. Find the sum of $\angle v$ and $\angle w$.

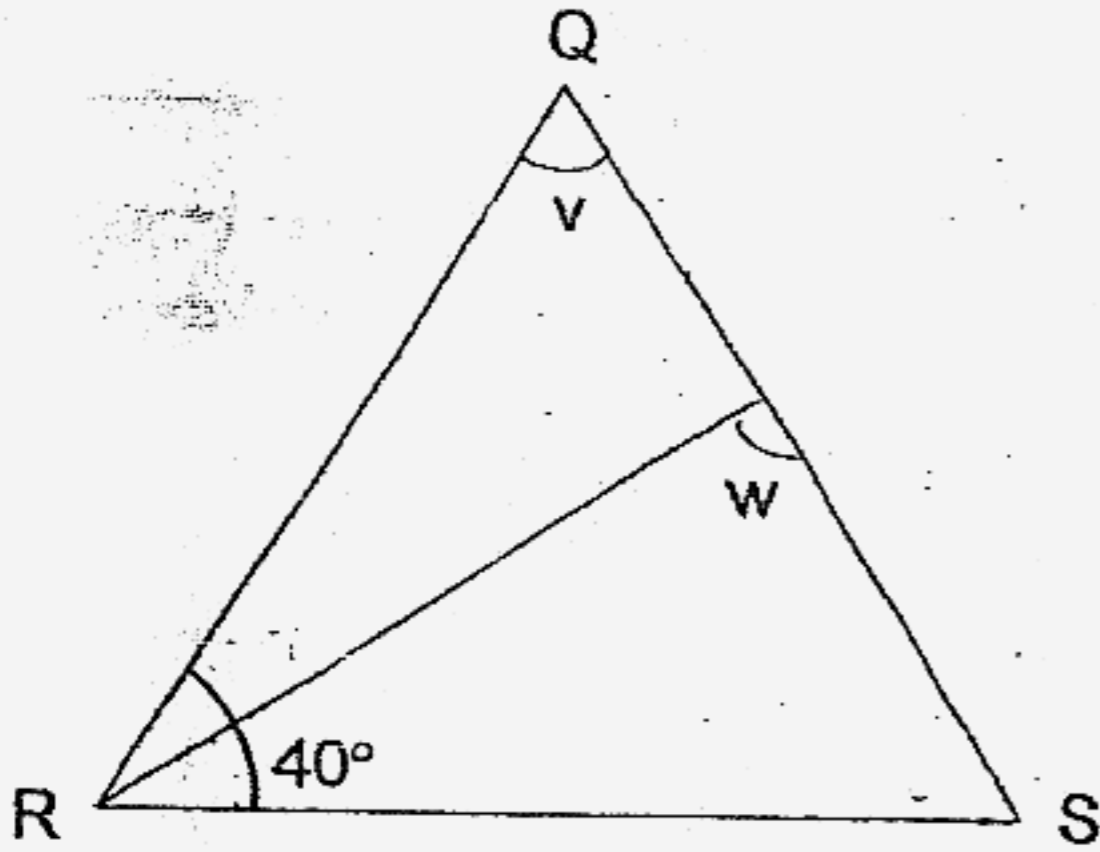

Ans: _____

35. Randy uses 20 bowls of water to fill 0.25 of a fish tank. He uses another 20 bowls and 26 bottles of water to fill the rest of the fish tank. If each bottle can hold 0.75 litres of water, what is the capacity of the fish tank?

Ans: _____ litres

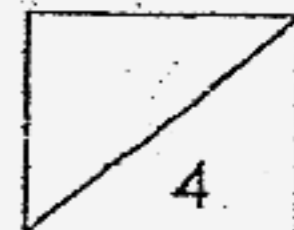

For questions 36 to 48, show your working clearly in the space below each question and write your answers in the spaces provided.
The number of marks awarded is shown in brackets [] at the end of each question or part-question. (50 marks)

36. Siva has a total of 30 pencils and notebooks. If he exchanges every notebook for 2 pencils, he will have 50 pencils. How many notebooks does Siva have?

Answer: _____ [3]

37. Jun Wei and Ahmad had an equal amount of money. Each day, Jun Wei spent \$36 and Ahmad spent \$21. When Jun Wei used up all this money, Ahmad still had \$525 left. How much did each of them have at first?

Answer: _____

98

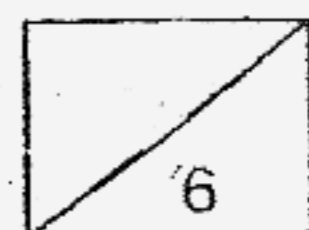

38. In the figure below, not drawn to scale, $HL = 18$ cm and $FH = 22$ cm. $FG = GH$, $HK = KL$ and $EJ = 9$ cm. Find the total area of the shaded parts.

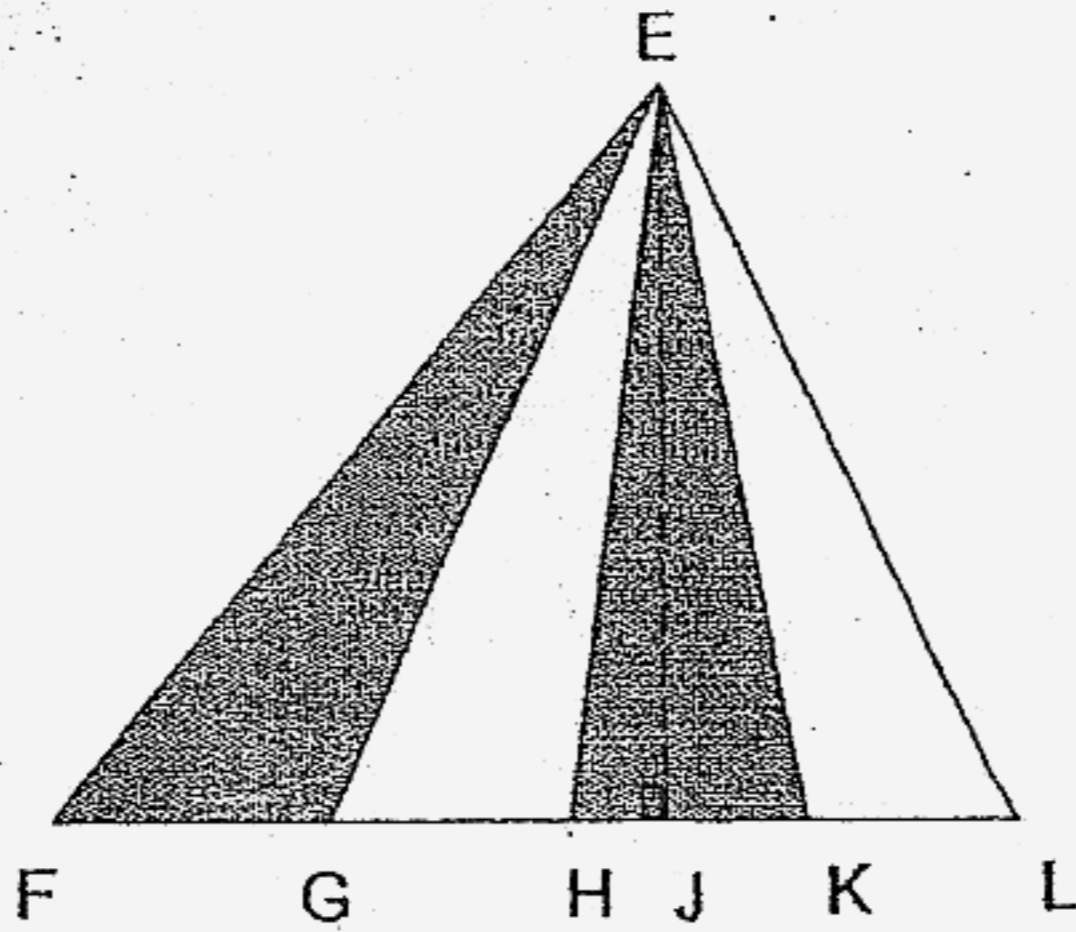

Answer: _____ [3]

39. In the figure below not drawn to scale, AB and CD are straight lines. If $\angle x$ is three times as large as $\angle y$, find the difference between $\angle z$ and $\angle x$.

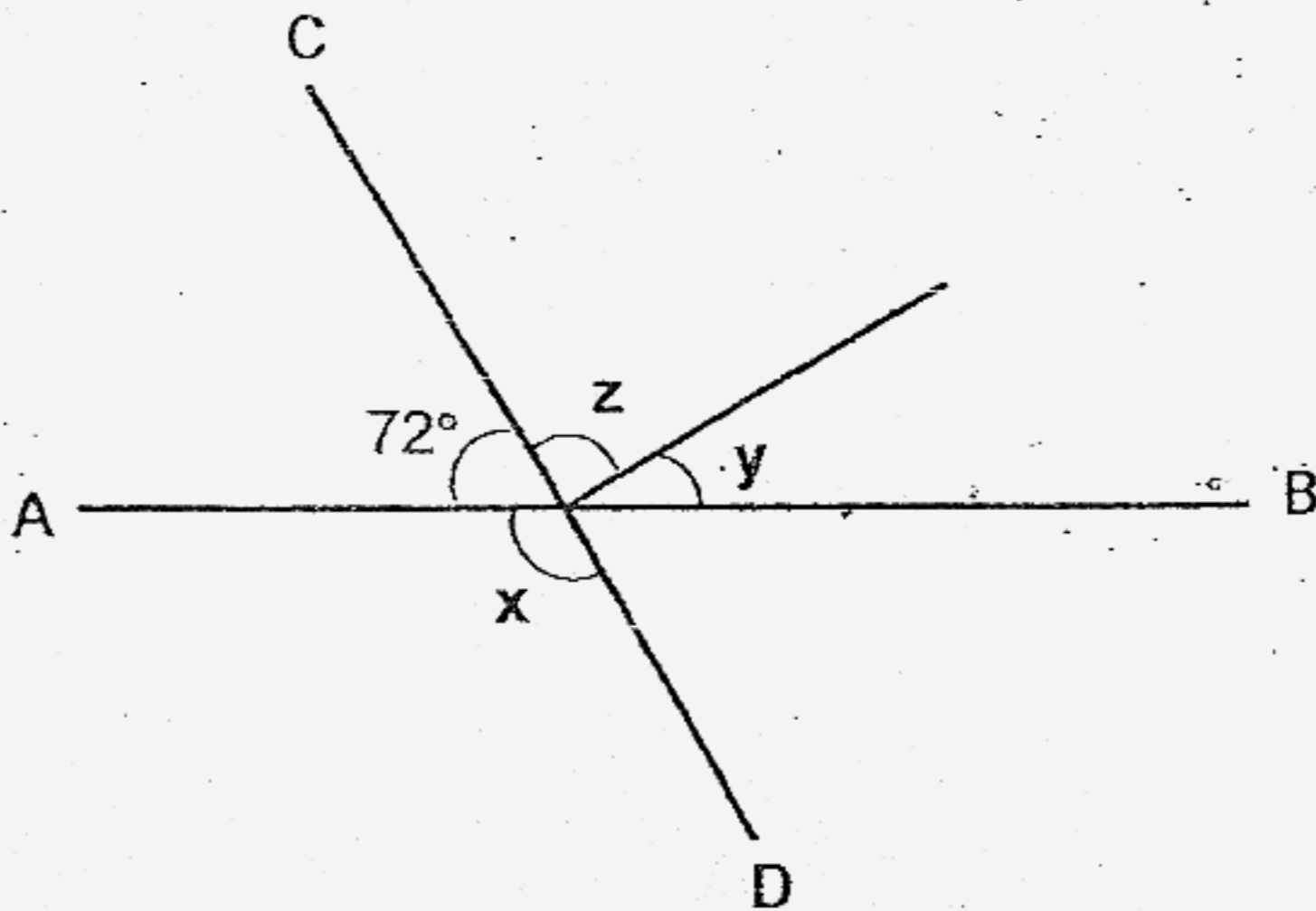

Answer: _____ [3]

40. Draw a triangle ABC in which $AB = AC = 6$ cm and $\angle BAC = 80^\circ$. Measure BC.

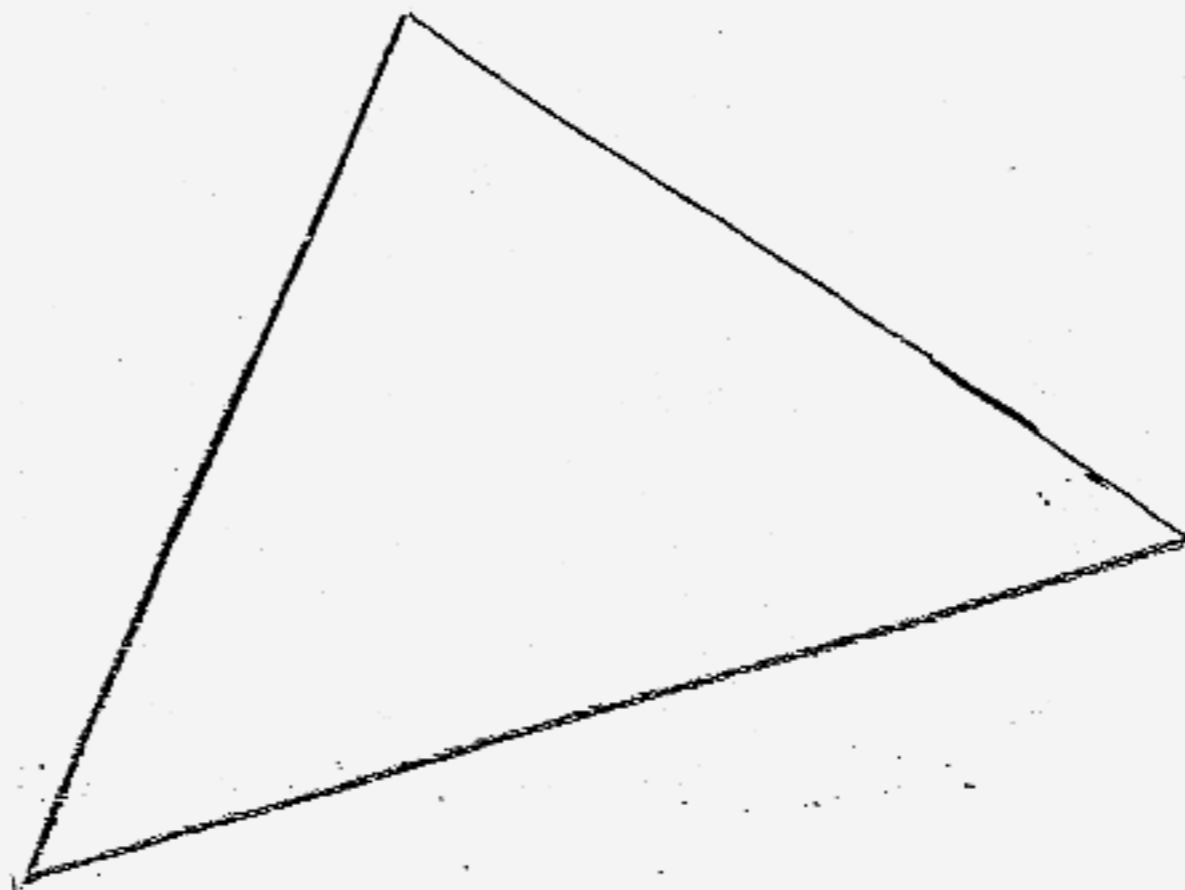

Answer: _____ [3]

41. A container weighs 22 kg when filled with Liquid B. The same container weighs 7 kg when filled with Liquid C. If Liquid B is 5 times as heavy as Liquid C, what is the mass of the container?

Answer: _____ [3]

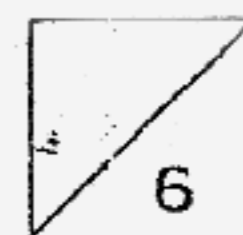

42. Bobby, Edward and Kelvin made a bottle of paper stars. The number of paper stars Bobby made was 21 more than $\frac{1}{4}$ the total number of paper stars in the bottle. The number of paper stars Edward made was 30 more than $\frac{1}{4}$ of the remaining number of paper stars in the bottle. Kelvin made the remaining 114 paper stars. How many paper stars did they make in all?

Answer: _____

-
43. A, B and C are three numbers. The average of A, B and C is 5 greater than the average of A and B. If C is 38, find the total of A, B and C.

Answer: _____ [4]

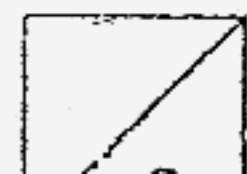

44. A big rectangular tank measures 80 cm by 60 cm by 40 cm, is $\frac{1}{4}$ filled with water. $\frac{4}{5}$ of a smaller rectangular tank is also filled with water. The ratio of the volume of water in the big rectangular tank to that in the smaller rectangular tank is 3 : 2. Find the capacity of the smaller tank in litres.

Answer: _____ [4]

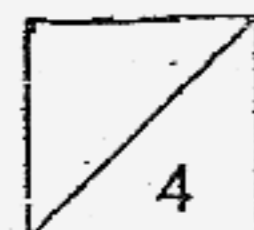

45. A box contained 50¢ coins and 20¢ coins in the ratio 2 : 3. Peter took out four 50¢ coins, exchanged them for 20¢ coins and put the money back into the box. The ratio then became 2 : 7. Find the sum of money in the box at first.

Answer: _____ [5]

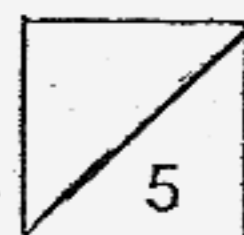

46. The following shows a solid made up of cubes of side 4 cm.

- (a) Find the volume of the solid.
- (b) If Ming Hui decides to colour the surface area green, find the total area that he has to colour.

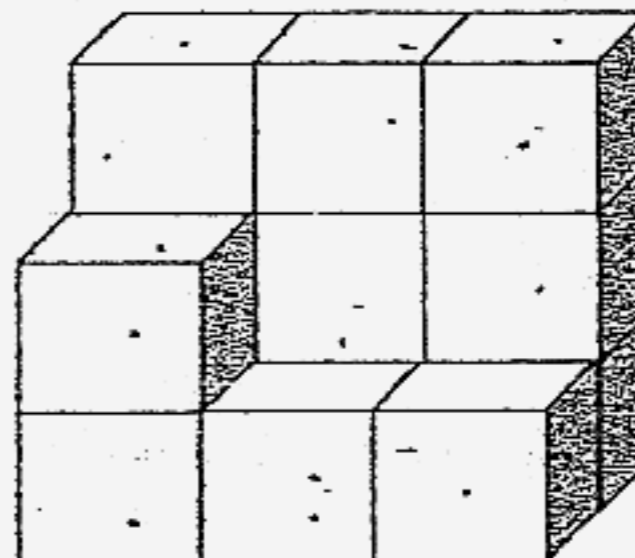

Answer: _____ (2)

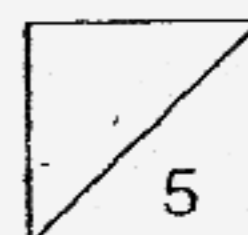

47. ABCD is a rhombus and CDEF is a square. $\angle DAB$ is 124° .

- Find (a) $\angle BDF$
 (b) $\angle BFC$

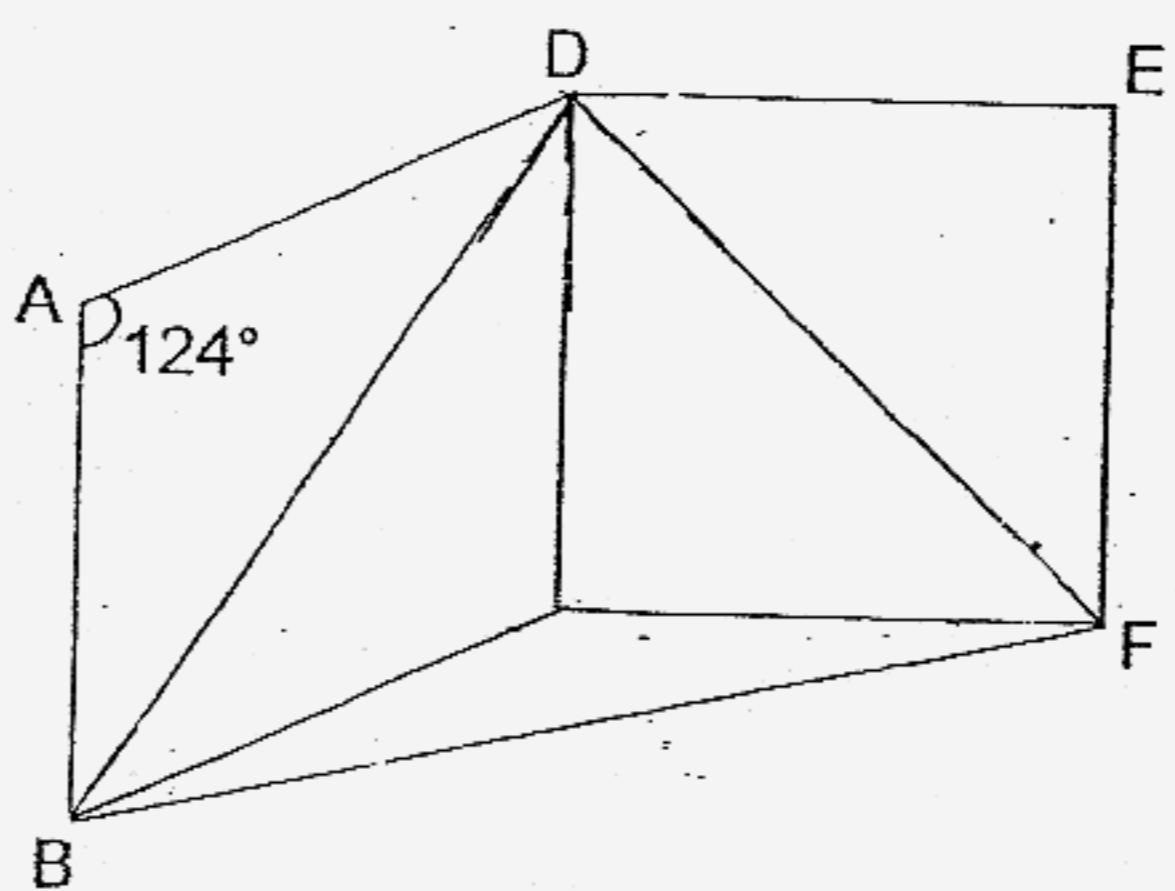

Answer: (a) _____ [3]

(b) _____ [2]

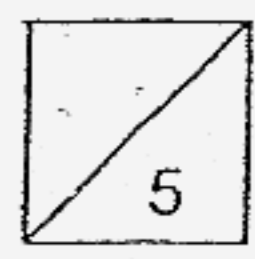

48. Devi's salary and Minah's salary are in the ratio of 4 : 5. If Devi's salary is increased by 30%, by what percentage must Minah's salary be increased so that their salaries will be the same?

Answer: _____ [5]

— CHECK YOUR WORK CAREFULLY —

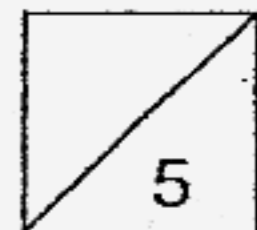

Ai Tong Primary School

Primary 5 Maths SA2 Exam (2007)*Answer Keys*

Q1	Q2	Q3	Q4	Q5
4	3	1	2	2
Q6	Q7	Q8	Q9	Q10
3	2	1	2	4
Q11	Q12	Q13	Q14	Q15
3	3	2	2	4

16. 6

17. 15876

18. $6\frac{7}{8}$

19. 7 : 10

20. 230

21. 138g

22. 60

23. \$34

24. 2430cm³

25. \$28944

26. 50

27. 99 sweets

28. 30cm²

29.

30. 16005 words

31. 1280cm³

32. 99°

33. 1200 erasers

34. 140°

35. 39 litres

36. 20 notebooks
37. \$1260
- 38a. $22\text{cm} \div 2 = 11\text{cm}$
 $\frac{1}{2} \times 9\text{cm} \times 11\text{cm}$
 $= 49.5\text{cm}^2$
 $18\text{cm} \div 2 = 9\text{cm}$
 $\frac{1}{2} \times 9\text{cm} \times 9\text{cm}$
 $= 40.5\text{cm}^2$
 $(40.5 + 49.5)\text{cm}^2 = 90\text{cm}^2$
39. $\angle x = 180^\circ - 72^\circ - 108^\circ$
 $= 108^\circ \div 3 = 36^\circ$
 $\angle z = 180^\circ - 36^\circ = 72^\circ$
 $= 108^\circ - 72^\circ = 36^\circ$
40. 7.7cm
41. 3.25kg
42. 284 paper stars
43. 84
44. $80\text{cm} \times 60\text{cm} \times 40\text{cm} = 192000\text{cm}^3$
 $\frac{1}{4} \times 192000\text{cm}^3 = 48000\text{cm}^3$
 $48000\text{cm}^3 \div 3 = 16000\text{cm}^3$
 $16000\text{cm}^3 \times 2 = 32000\text{cm}^3$
 $32000\text{cm}^3 \div 4 = 8000\text{cm}^3$
 $8000\text{cm}^3 \times 5 = 40000\text{cm}^3$
 $= 40\text{l}$
45. \$9.60

46a. $4\text{cm} \times 4\text{cm} \times 4\text{cm} = 64\text{cm}^3$
Solid has 13 cubes
 $64\text{cm}^3 \times 13 = 832\text{cm}^3$

46b. 640cm^2

47a. $180^\circ - 124^\circ = 56^\circ$
 $56 \div 2 = 28$
 $90^\circ \div 2 = 45^\circ$
 $\angle\text{BDF} = 45^\circ + 28^\circ$
 $= 73^\circ$

47b. $124^\circ + 90^\circ = 214^\circ$
 $360^\circ - 214^\circ = 146^\circ$
 $180^\circ - 146^\circ = 34^\circ$
 $\angle\text{BFC} = 34^\circ \div 2 = 17^\circ$

48. 4%