



Anglo-Chinese School (Primary)

MID-YEAR EXAMINATION 2007  
MATHEMATICS

Booklet A

Name: \_\_\_\_\_ (     )

Class: Primary 5\_\_

Date: 8 May 2007

Duration of Booklet A & B: 2 h 15 min

THIS BOOKLET CONTAINS PAGES 1 to 5.  
DO NOT OPEN THIS BOOKLET UNTIL YOU ARE TOLD TO DO SO.  
FOLLOW ALL INSTRUCTIONS CAREFULLY.

## SECTION A (20 MARKS)

Questions 1 to 10 carry 1 mark each.

Questions 11 to 15 carry 2 marks each.

For each question, four options are given. One of them is the correct answer.

Make your choice (1, 2, 3 or 4). Shade the correct oval (1, 2, 3 or 4) on the Optical Answer Sheet (OAS).

1. The digit '8' in 5 687 143 is in the \_\_\_\_\_ place.
- 1) hundreds
  - 2) thousands
  - 3) ten thousands
  - 4) hundred thousands
2. Which of the following numbers when rounded off to the nearest ten thousand is 650 000?
- 1) 644 123
  - 2) 651 132
  - 3) 6 051 123
  - 4) 6 550 123
3.  $82 \times 80 =$  \_\_\_\_\_
- 1)  $828 \times 10$
  - 2)  $8 \times 2 \times 60$
  - 3)  $82 \times 8 + 10$
  - 4)  $(80 \times 80) + (2 \times 80)$

4. Express  $2\frac{1}{3}$  years in months.

- 1) 16 months
- 2) 17 months
- 3) 27 months
- 4) 28 months

5. Zhi Wei spent  $\frac{3}{4}$  of his money on a soccer ball and  $\frac{1}{3}$  of the remaining money on lunch. What fraction of his money had he left?

- 1)  $\frac{1}{3}$
- 2)  $\frac{1}{6}$
- 3)  $\frac{2}{7}$
- 4)  $\frac{1}{12}$

6.  $24 \times 65 = \underline{\hspace{2cm}} \times 30$ .

- 1) 52
- 2) 156
- 3) 520
- 4) 1 560

7. Triangle ABC has a height 6 cm and an area of  $54 \text{ cm}^2$ . Find the base of triangle ABC.

- 1) 8
- 2) 9
- 3) 16
- 4) 18

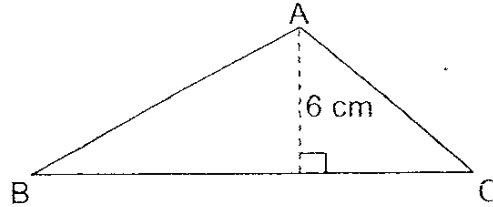

8. Mr Ang bought 4 chairs and 1 table for \$245. The table cost 3 times as much as a chair. How much did he pay for the table?

- 1) \$35
- 2) \$49
- 3) \$105
- 4) \$140

9. CJ is facing north. If he turns  $135^\circ$  anti-clockwise, which direction will he be facing then ?

- 1) North-East
- 2) North-West
- 3) South-East
- 4) South-West

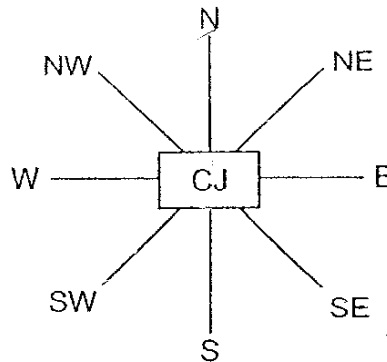

10. Find the area of the figure. (Figure not drawn to scale)

- 1)  $60 \text{ cm}^2$
- 2)  $68 \text{ cm}^2$
- 3)  $120 \text{ cm}^2$
- 4)  $136 \text{ cm}^2$

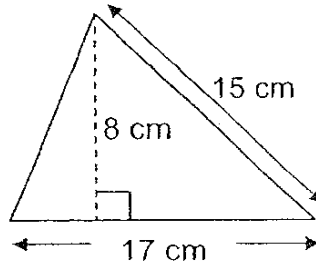

11. Line PQ and line RS are straight lines. Find  $\angle QOT$ .

- 1)  $45^\circ$
- 2)  $58^\circ$
- 3)  $62^\circ$
- 4)  $74^\circ$

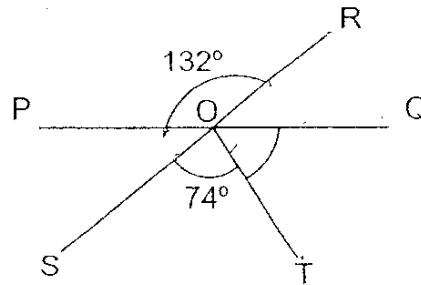

12. Harry took  $\frac{1}{2}$  h to complete his homework. His sister took  $\frac{1}{4}$  h longer to complete her homework. Express the ratio of the time taken by Harry to complete his homework to the time taken for his sister to complete her homework.

- 1) 1 : 2
- 2) 2 : 1
- 3) 2 : 3
- 4) 3 : 4

13. A piece of wire 112 cm is cut into 3 parts. If the longest piece is twice the length of the second piece and the shortest piece is 16 cm, find the length of the longest piece of wire.
- 1) 28 cm
  - 2) 32 cm
  - 3) 56 cm
  - 4) 64 cm
14. Madam Loh had  $\frac{5}{6}$  kg of rice. She packed them equally into 10 small containers. What was the mass of rice in each container?
- 1)  $\frac{1}{3}$  kg
  - 2)  $\frac{5}{6}$  kg
  - 3)  $\frac{1}{12}$  kg
  - 4)  $\frac{5}{12}$  kg
15. Gopal has some red, blue and white marbles.  $\frac{1}{7}$  of the marbles are red,  $\frac{2}{3}$  are blue and the rest are white. If he has 28 white marbles, how many marbles does he have altogether?
- 1) 49
  - 2) 84
  - 3) 119
  - 4) 147



Anglo-Chinese School (Primary)

MID-YEAR EXAMINATION 2007  
MATHEMATICS

Booklet B

Name: \_\_\_\_\_ (     )

Class: Primary 5

Date: 8 May 2007

Duration of Booklet A & B: 2 h 15 min

Section	Contents	Marks	Marks Obtained
A	Multiple Choice Questions	20	
B	Short Answers: Part I	10	
	Short Answers: Part II	20	
C	Problem Sums	50	
Total Marks		100	
Parent's signature			

THIS BOOKLET CONTAINS PAGES 1 to 18.  
DO NOT OPEN THIS BOOKLET UNTIL YOU ARE TOLD TO DO SO.  
FOLLOW ALL INSTRUCTIONS CAREFULLY.

# STAR ZEST HOME TUITION TEL 63845607

## SECTION B (30 MARKS)

Questions 16 to 25 carry 1 mark each. Write your answer in the spaces provided. For questions which require units, give your answer in the units stated. (10 marks)

16. Bread Bistro sold 24 567 loaves of bread last year. Express this number to the nearest thousand.

Answer : \_\_\_\_\_ loaves

17. Find the remainder when 2 988 is divided by 14.

Answer : \_\_\_\_\_

18. Jared and Francis shared \$90 in the ratio 5 : 1. How much more money did Jared receive than Francis?

Answer : \$ \_\_\_\_\_



19. Part of the table below was accidentally torn off. The table shows the number of pupils from class 4A scoring within various mark range in a Science topical test. 35 pupils scored above 64 marks. How many pupils scored in the mark range of 65 to 74?

Mark Range	Number of pupils
91 to 100	8
75 to 90	6
65 to 74	
50 to 64	

Answer : \_\_\_\_\_

20. Find the difference between  $1\frac{1}{3}$  and  $\frac{3}{4}$ .

Answer : \_\_\_\_\_

21. Rahmin weighs 28kg. Ali weighs 4kg less than Rahmin. Express the ratio of Rahmin's mass to the two boys total mass.

Answer : \_\_\_\_\_

22. Find the area of the shaded figure. (Figure not drawn to scale)

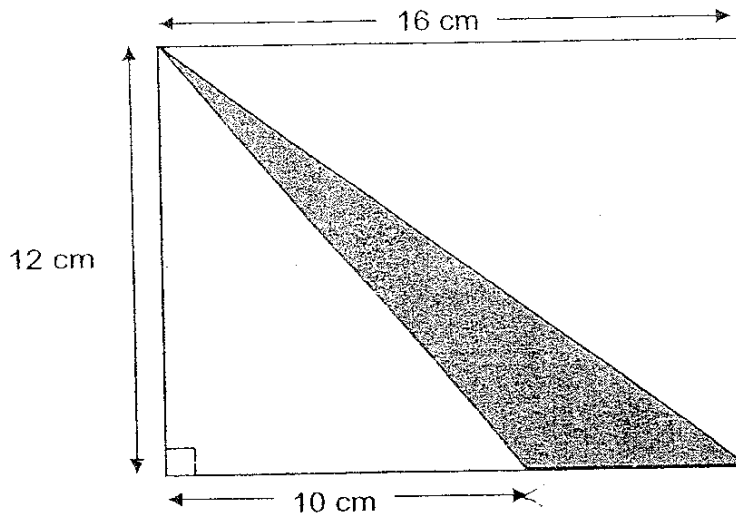

Answer : \_\_\_\_\_ cm<sup>2</sup>

23. In the figure, not drawn to scale, AB and CD are straight lines. Find  $\angle AOE$ .

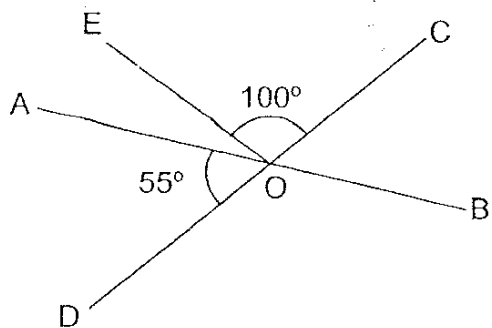

Answer : \_\_\_\_\_<sup>o</sup>

24. Find the value of  $\frac{1}{3} \div 3$ .

Answer : \_\_\_\_\_

25. Find the value of  $(4 + 3) \times 5 + 10 \div 5$ .

Answer : \_\_\_\_\_

# STAR ZEST HOME TUITION TEL 63845607

Questions 26 to 35 carry 2 marks each. Show all workings clearly in the space below each question and write your answers in the spaces provided. For questions which require units, give your answer in the units stated (20 marks)

26. Mary was awake for  $\frac{2}{3}$  of the day. She spent  $\frac{1}{4}$  of her time awake studying. What fraction of the day did Mary spend studying?

Answer : \_\_\_\_\_

27.  $99 \times 89 = \square \times 89 - 89$ . What is the missing number in the box?

Answer : \_\_\_\_\_

28. Benny wants to purchase a new car at \$82 000. He has to pay \$10 000 as downpayment. The remaining amount will be paid in monthly instalment for 3 years. How much did Benny need to pay for his monthly instalment?

Answer : \$ \_\_\_\_\_

29. In the figure, not drawn to scale, the shaded area is  $\frac{2}{5}$  of the unshaded area. Find the area of the shaded area.

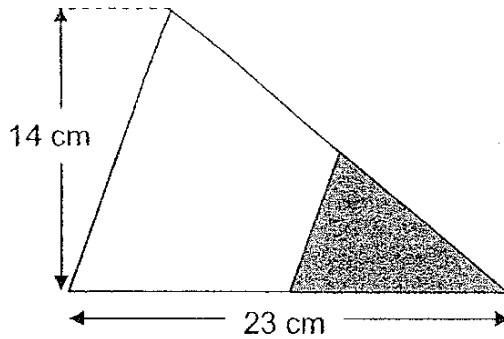

Answer : \_\_\_\_\_ cm<sup>2</sup>

30. Find the area of a square with side  $\frac{2}{3}$  m.

Answer : \_\_\_\_\_ m<sup>2</sup>

31. In the figure, not drawn to scale, AOB is a straight line, Find  $\angle AOD$ .

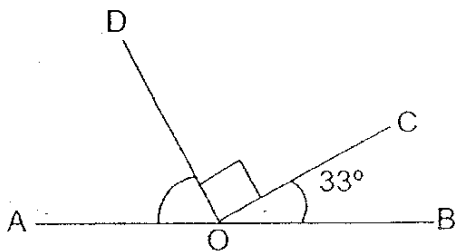

Answer : \_\_\_\_\_ °

32. Find the area of the shaded area.

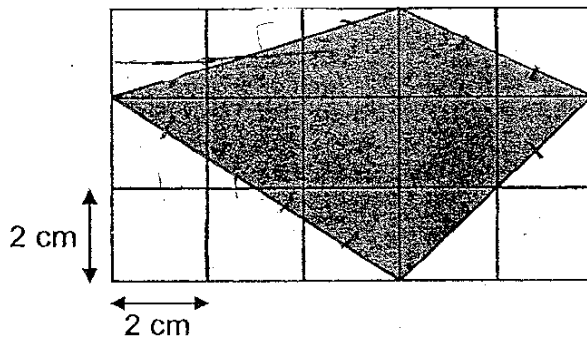

Answer : \_\_\_\_\_ cm<sup>2</sup>

33. In the figure, not drawn to scale,  $\angle a$  is three times the size of  $\angle b$ . Find  $\angle b$ .

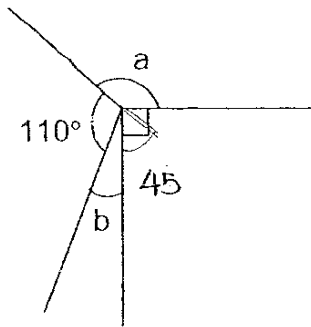

Answer : \_\_\_\_\_°

34. Beckham and his son have a total mass of 145 kg. If the ratio of Beckham's mass to his son's mass is 23 : 6, find the difference in their mass.

Answer : \_\_\_\_\_ kg

35. The sum of two numbers, A and B is 1 525. If the value of A is four times the value of B, find the value of A.

Answer : \_\_\_\_\_

## SECTION C- Problem Sums (50 MARKS)

For each question from 36 to 48, show your working and mathematical statements clearly in the space provided for each question. Write your answers in the spaces provided. The number of marks available is shown in the brackets [ ] at the end of each question or part-question. (50 marks)

36. Auntie Sue bought 23 boxes of pineapple tarts. Each box contains 12 pineapple tarts. She put 15 pineapple tarts in one jar. How many jars will she need to pack all the pineapple tarts?

Answer : \_\_\_\_\_ [3M]

37. Bryan read  $\frac{1}{3}$  of a story book on Monday and  $\frac{5}{6}$  of the remainder on Tuesday. He completed reading the rest of the 48 pages on Wednesday. How many pages were there in the book?

Answer : \_\_\_\_\_ [3M]



38. In the figure shown below, ABC, DBE and AEF are straight lines.  
Find  $\angle BAE$ .

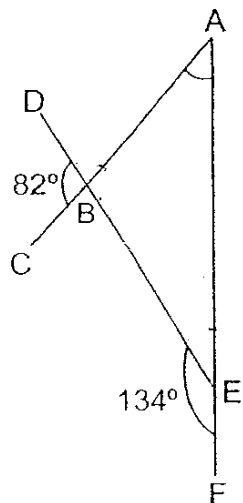

Answer : \_\_\_\_\_ [3M]

39. Find the sum of  $1 + 2 + 3 + \dots + 98 + 99 + 100$ .

Answer : \_\_\_\_\_ [3M]

40. In 2007, Mr Tan is 38 years old and his son is 16 years old. In how many years' time will Mr Tan's age be twice the age of his son?

Answer : \_\_\_\_\_ [3M]

41. Thomas had \$126. He gave  $\frac{4}{9}$  of his money to his mother and gave the rest of the remainder to his two sisters, Jessie and Mabel, in the ratio 2 : 3. Mabel used  $\frac{3}{7}$  of her money to buy a bag. How much money had Mabel left?

Answer : \_\_\_\_\_ [4M]

42. Michael, Jeremy and Andrew shared 320 marbles in the ratio 1 : 2 : 5.  
Jeremy lost  $\frac{1}{2}$  of his marbles to Michael in the first round of game and  
Andrew lost  $\frac{1}{2}$  of his marbles to Jeremy in the second round of game.
- a) Find the ratio of the number of Michael's marbles to Jeremy marbles to Andrew's marbles after two round of games.
  - b) How many more marbles will Jeremy have than Michael if Andrew gave Michael 10 marbles after the second game?

Answer : (a) \_\_\_\_\_ [2M]

(b) \_\_\_\_\_ [2M]

43. Ken and Patrick had \$625 at first. After buying some books, the amount of money Ken has left is 4 times the amount of money he spent and the amount of money Patrick has left is 5 times the amount of money he spent. Find the amount of money Patrick have at first if they have a total of \$510 left.

Answer : \_\_\_\_\_ [4M]

44. Shawn spent  $\frac{1}{6}$  of his money on a story book,  $\frac{1}{12}$  of his money on a pen and  $\frac{1}{2}$  of the remaining money on a box of poster paint.
- a) What fraction of his money was left?
  - b) If he spent \$6.00 on the box of poster paint, how much money did he have at first?

Answer : (a) \_\_\_\_\_ [2M]

(b) \_\_\_\_\_ [2M]

45. There are 85 plates of chicken rice for 80 people. Each adult eats 2 plates of chicken rice and every 3 children share 1 plate of chicken rice. Find the number of adults and children respectively.

Answer: Adults : \_\_\_\_\_ [2M]

Children : \_\_\_\_\_ [2M]

46. Study the pattern in the diagram shown below.

Pattern 1

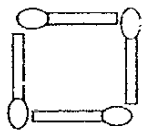

Pattern 2

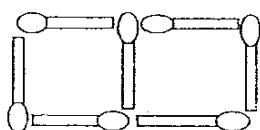

Pattern 3

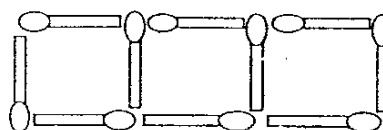

a) Complete the table below.

Pattern Number	Number of matchsticks
1	4
2	7
3	10
5	

[1]

b) How many matchsticks are there in Pattern 10?

c) Which pattern will have 61 matchsticks?

Answer : (b) \_\_\_\_\_ [2M]

(c) \_\_\_\_\_ [2M]

47. There was a car exhibition at the Singapore Expo.  $\frac{2}{9}$  of the visitors were children. There were 4 000 more adults than children. The ratio of the number of boys to the number of girls was 3 : 5. The ratio of the number of men to the number of women was 3 : 1. Find the number of all male visitors in the car exhibition.

Answer : \_\_\_\_\_ [5M]



48. Four boys, Alex, Bryan, Calvin and Derrick, each have some stamps. The number of stamps Alex has is  $\frac{1}{2}$  of the total number of stamps Bryan, Calvin and Derrick have. The number of stamps Bryan has is  $\frac{1}{3}$  of the total number of stamps Alex, Calvin and Derrick have. The number of stamps Calvin has is  $\frac{1}{4}$  of the total number of stamps Alex, Bryan and Derrick have. If Derrick has 78 stamps, find the total number of stamps Alex and Bryan have altogether.

Answer : \_\_\_\_\_ [5M]

**END OF PAPER**

Setter: Ms Yvonne Teo  
Vetted by: P5 Math Teachers

24

## ACS Primary School

### Primary 5 Maths SA1 Exam (2007)

#### Answer Keys

Q1	Q2	Q3	Q4	Q5
3	2	4	4	2
Q6	Q7	Q8	Q9	Q10
1	4	3	4	2
Q11	Q12	Q13	Q14	Q15
2	3	4	3	4

16. 25000

17. 6

18. \$60

19. 21

20.  $\frac{7}{12}$

21. 7 : 13

22. 36cm<sup>2</sup>

23. 25°

24.  $\frac{1}{9}$

25. 37

26.  $\frac{1}{6}$

27. 100

28. \$2000

29. 46cm<sup>2</sup>

30.  $\frac{4}{9}$  m<sup>2</sup>

31. 57°

32. 30cm<sup>2</sup>

33. 40°

34. 85kg

35. 1220

36.  $23 \times 12 = 7$   
 $276 \div 15 = 18 \text{ r}6$   
 $18 + 1 = 19$   
She will need 19 jars

37.  $1\text{u} \longrightarrow 48$   
 $48 \times 9 = 432$   
There were 432 pages in the book.

38.  $82^\circ + 46^\circ = 128^\circ$   
 $180^\circ - 128^\circ = 52^\circ$   
 $\angle \text{BAE}$  is  $52^\circ$

39.  $100 \div 2 = 50$   
 $100 + 1 = 101$   
 $101 \times 50 = 5050$   
The sum is 5050

40.  $38 - 16 = 22$   
 $22 - 16 = 6$   
In 6 years time, Mr Tam's age will be twice the age of his son.

41.  $1 - \frac{4}{9} = \frac{5}{9}$   
 $\frac{5}{9} \times \frac{126}{14} = 70$   
 $70 \div 5 = 14$   
 $14 \times 3 = 42$   
 $1 - \frac{3}{7} = \frac{4}{7}$   
 $\frac{4}{7} \times 42 = 24$

She had \$24 left.

42.  $320 \div 8 = 40$   
 $40 - \text{m}$   
 $40 \times 2 = 80 - \text{J}$   
 $40 \times 5 = 200 - \text{A}$   
 $80 \div 2 = 40$   
 $40 + 40 = 80 - \text{m}$   
 $200 \div 2 = 100 - \text{A}$   
 $100 + 40 = 140\text{J}$

42a.  $M : J : A$   
 $80 : 140 : 100$   
 $40 : 70 : 50$   
 $8 : 14 : 10$   
 $4 : 7 : 5$

The ratio is 4 : 7 : 5

42b.  $100 - 10 = 90$   
 $80 + 10 = 90$   
 $140 - 90 = 50$

Jeremy will have 50 more marbles than Michael.

43.  $625 - 510 = 115$   
 $115 \times 4 = 460$   
 $510 - 460 = 50$   
 $50 \times 3 = 300$   
Patrick has \$300 at first.

44a.  $\frac{3}{8}$  of the money was left.

44b. He had \$16 at first.

45. Adults = 35  
Children = 45

46a. 16

46b. There will be 31 matchsticks in pattern 10.

46c. 61 matchsticks

47. 4800

48. 210