

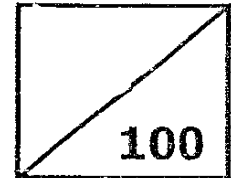

Rosyth School
Second Continual Assessment 2007
Mathematics
Primary 5



Name: _____

Class: Pr 5- _____ Register No. _____ Duration: 2 hours 15 min

Date: 21 August 2007

Parent's Signature: _____

BOOKLET A

Instructions to Pupils:

1. Do not open any booklet until you are told to do so.
2. Follow all instructions carefully.
3. This paper consists of 3 parts, Sections A, B and C.
4. For questions 1 to 15 in Booklet A, shade the correct ovals on the Optical Answer Sheet (OAS).

	Maximum	Marks Obtained
Section A	20	
Section B	30	
Section C	50	
Total	100	

* Booklet A consists of 6 pages altogether.

This paper is not to be reproduced in part or whole without the permission of the Principal.

Section A

Questions 1 to 10 carry 1 mark each. Questions 11 to 15 carry 2 marks each. For each question, four options are given. One of them is the correct answer. Make your choice (1, 2, 3 and 4). Shade the correct answer on the OAS (Optical Answer Sheet). (20 marks)

1) Round off 150 837 to the nearest thousand.

(1) 150 000

(2) 150 800

(3) 151 000

(4) 200 000

2) What is the value of $36 - (10 + 14) \div 2$?

(1) 12

(2) 20

(3) 24

(4) 33

3) $5\frac{7}{12} - 3\frac{1}{12} = \boxed{}$

(1) $8\frac{2}{3}$

(2) $2\frac{2}{3}$

(3) $2\frac{7}{12}$

(4) $2\frac{1}{2}$

110

110

- 4) Mr Toh bought 56 l of paint. His workers used $\frac{7}{8}$ of the paint to paint some offices.
How many litres of paint did the workers use?

- (1) 7 l
- (2) 14 l
- (3) 42 l
- (4) 49 l

- 5) Jen Yee is facing the letter 'G'. If she makes a 135° turn clockwise, which letter will she be facing?

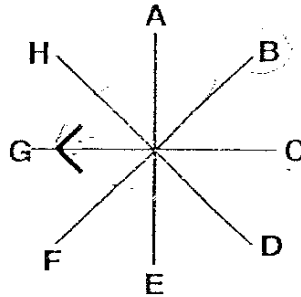

- (1) H
 - (2) F
 - (3) D
 - (4) B
- 6) Which of the following is the biggest number that can be divided by 5 with no remainder?
- (1) 9305
 - (2) 9350
 - (3) 9503
 - (4) 9530

7) Carissa has 20.8 m of ribbon. If she cuts it into 400 equal pieces, what would be the length of each short piece of ribbon?

- (1) 0.052 m
- (2) 0.52 m
- (3) 83.2 m
- (4) 8320 m

8) Express $\frac{21}{30}$ as a percentage.

- (1) 7%
- (2) 21%
- (3) 30%
- (4) 70%

9) Elvin earned a total of 73 points after playing 5 games. Find the average number of points Elvin scored for the 5 games.

- (1) 14
- (2) 14.6
- (3) 15
- (4) 15.6

10) In the figure below, not drawn to scale, find $\angle a$.

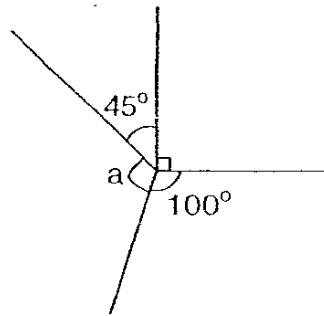

- (1) 125°
- (2) 145°
- (3) 215°
- (4) 235°

11) Calculate 0.84×76 .

- (1) 6.384
- (2) 63.84
- (3) 638.4
- (4) 6384

12) Kenneth bought some pens and files for \$40. He bought more pens than files. The extra number of pens cost \$5. If a pen and a file together cost \$5, how many files did he buy?

- (1) 7
- (2) 8
- (3) 10
- (4) 30

- 13) At a class party, Kevin has $\frac{7}{8}$ ℓ of orange juice and $\frac{3}{4}$ ℓ of apple juice left. He gave Jerrick $\frac{5}{7}$ of the orange juice and $\frac{2}{3}$ of the apple juice. What is the total volume of juice that Jerrick received?

(1) $1\frac{1}{8}$ ℓ

(2) $1\frac{8}{21}$ ℓ

(3) $1\frac{3}{8}$ ℓ

(4) $1\frac{5}{8}$ ℓ

- 14) $\frac{3}{5}$ of the pens in a box are red pens. 10% of the remainder are green pens and the rest are blue pens. There are 12 more red pens than blue pens in the box. How many pens are there altogether in the box?

(1) 20

(2) 40

(3) 50

(4) 200

114

114

15)

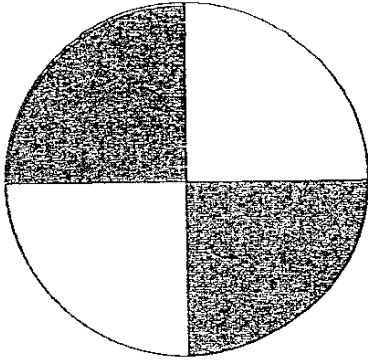

Circle

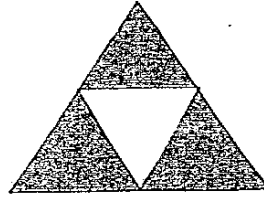

Equilateral
Triangle

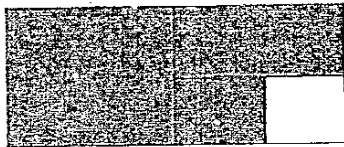

Rectangle

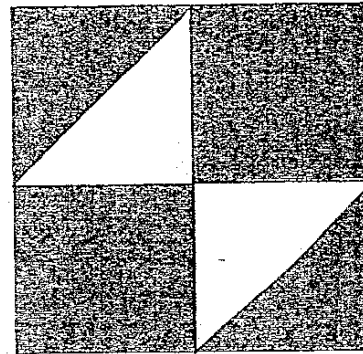

Square

Which 2 shapes have the same percentage of shaded areas?

- (1) Circle and Square
- (2) Equilateral Triangle and Rectangle
- (3) Equilateral Triangle and Square
- (4) Rectangle and Square

~END OF BOOKLET A~

115



Rosyth School
Second Continual Assessment 2007
Mathematics
Primary 5

Name: _____

Class: Pr. 5 _____ Register No. _____

Date: 21 August 2007 Parent's Signature: _____

BOOKLET B

Instructions to Pupils:

1. Do not open this booklet until you are told to do so.
2. Follow all instructions carefully.
3. This paper consists of 2 sections, sections B and C.
4. For questions 26 to 48, show all relevant working in the spaces provided.
5. ANSWER ALL THE QUESTIONS

* This paper consists of 15 pages altogether.

117
5

This paper is not to be reproduced in part or whole without the permission of the Principal.

Section B

Questions 16 to 25 carry 1 mark each. Write your answers in the spaces provided. For questions which require units, give your answers in the units stated. (10 marks)

16) Add the values of the digit 2 in 2 100 and 1, 200?

Ans: _____

17) Find the product of 76 and 45.

Ans: _____

18) May and her 3 children shared $\frac{2}{3}$ of a pie.
What fraction of the pie did each of them get?

Ans: _____

19) $\frac{5}{6} \square - \frac{1}{4} = \frac{7}{12}$

What is the missing sign in the equation?

Ans: _____

20) The ~~figure~~ ^{square} rectangle below is not drawn to scale. Find $\angle f$.

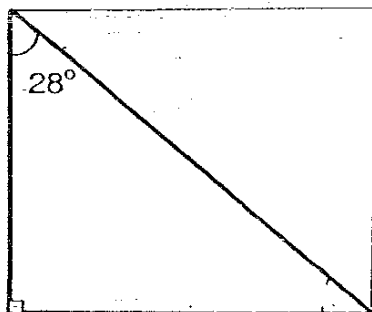

Ans: _____^o

21) If XY is a straight line, what is the sum of $\angle a$, $\angle b$ and $\angle c$?

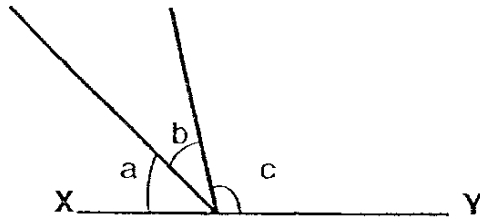

Ans: _____^o

22) 2 tenths + 8 hundredths + 6 thousandths = _____

Ans: _____

23) Express $2\frac{7}{10}$ as a decimal correct to 2 decimal places.

Ans: _____

24) There were 20 apples in a basket. 12 apples were rotten.
What percentage of the apples were rotten?

Ans: _____

25) The average weight of 2 boys is 45kg.
If one of the boys weighs 35kg, what is the weight of the other boy?

Ans: _____ kg

Questions 26 to 35 carry 2 marks each. Show your working clearly in the space below each question and write your answers in the spaces provided. For questions which require units, give your answers in the units stated. (20 marks)

- 26) Toby used $\frac{1}{5}$ of his money to buy a toy car.
 He gave $\frac{1}{2}$ of the remainder to his mother. He had \$200 left.
 How much did he have at first?

Ans: \$ _____

- 27) The figure below is not drawn to scale.
 If MN, QR and ST are straight lines, find $\angle a$.

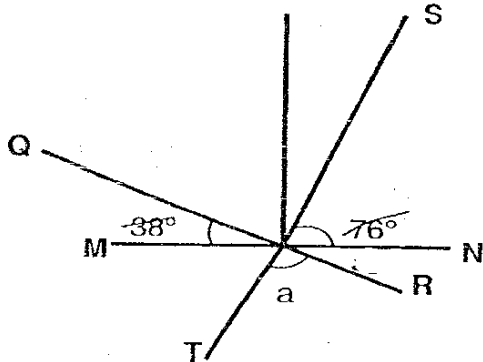

Ans: _____ °

- 28) Joe was facing the library. He turned clockwise to face south-west.
 What angle did he turn through?

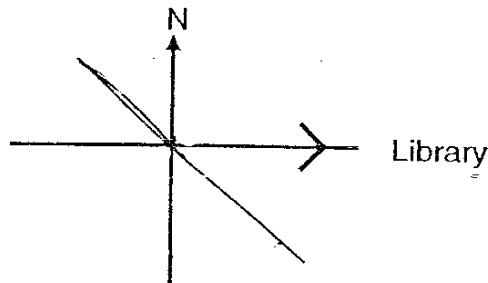

120

Ans: _____ °

29) Kevin has 135 straws. If his sister ^{gives} gave him 70 straws, they will have an equal number of straws. How many straws does his sister have?

Ans: _____

30) The cost of tiling a floor is \$46 ^{for every} per metre square. ^{metre}
How much does it cost to tile a square floor of sides 7m?

Ans: \$ _____

31) 25% of the animals at the SPCA are cats. 15% are rabbits and the rest are dogs.
If there are 180 dogs, how many animals are there altogether at the shelter?

Ans: _____

32) Andy spent \$21 on 12 notebooks and 6 pens. If the cost of 2 pens is the same as the cost of 3 notebooks, find the cost of each pen.

Ans: \$ _____

- 33 Penny deposited \$2 000 into a savings account. The interest rate is 4% per year. After a year, she decided to withdraw all her money and close her account. What is the total amount of money she withdrew?

Ans: \$ _____

- 34) Jack scored 70 marks in his CA1 Mathematics paper and 84 in the recent CA2 paper. Express the increase in marks as a percentage of Jack's first CA mark.

Ans: _____

- 35) A school library has 100 more Chinese books than Malay books. It has twice as many English books as Chinese books. The average number of books for each language is 380. How many Malay books are there?

122

Ans: _____

Section C

For questions 36 to 48, show your working clearly in the space provided for each question and write your answers in the spaces provided.

The number of marks available is shown in brackets [] at the end of each question or part question. (50 marks)

- 36) At the Rosyth jumble sale, old story books are sold for \$0.40 each or 3 for \$1.00. What is the maximum number of books you can buy with \$18.90?

Ans: _____ [3]

- 37) Peter paid \$4.80 for an ice-cream and 2 fish burgers. If each fish burger cost 60 cents more than an ice-cream, what was the price of an ice-cream?

Ans: _____ [3]

123

- 38) Haikal's height is $\frac{7}{8}$ of Dillon's height. Edward is $\frac{3}{4}$ as tall as Haikal. If Dillon's height is 176cm, find Edward's height in centimetres.

Ans: _____ [3]

-
- 39) The total height of eight children is 9m 20cm. If the average height of three of them is 1m 40cm, find the average height of the other five children.

124

Ans: _____ [3]

- 40) 1 kg of sugar cost \$0.85 and 1 kg of rice cost \$6.50. A housewife bought 5kg of sugar and 8kg of rice. How much would she have to pay for 5 kg of sugar and 8kg of rice?

Ans: _____ [3]

-
- 41) Mark had a box of pencils. He gave 40 pencils to Alex and 15 pencils to Haresh. Mark bought another 84 pencils. After that, he gave half of the number of pencils he had to Su Lynn. He was finally left with 48 pencils. How many pencils had Mark at first?

Ans _____ [3]

- 42) John and Mary had \$57.50 altogether. When Mary gave \$3.85 to John, they found that both of them had equal amounts of money.
- a) How much more money did Mary have than John at first?
 - b) How much did John have at first?

126

Ans: (a) _____ [1]

(b) _____ [3]

- 43) A metal container weighed 2.8 kg when it was $\frac{1}{4}$ filled with water. The same metal container weighed 4.2 kg when it was $\frac{5}{6}$ full of water. What is the weight of the empty metal container in kilograms?

Ans: _____ [4]

- 44) Rebecca and Kenneth had a total of \$80. After Kenneth spent $\frac{1}{3}$ of his money and Rebecca spent \$25, they had the same amount of money left. How much money had Rebecca at first?

128
Ans: _____ [4]

- 45) A shoe cabinet and a chair cost \$92 altogether. A shoe cabinet and a table cost \$212 altogether. A table costs 4 times as much money as a chair. If Miss Lee bought 2 tables, 3 chairs and 1 shoe cabinet, how much did she spend altogether?

Ans; _____ [5]

129

40) A baker baked 800 cookies. He sold 60% of them at 40 cents each. Then he packed the rest into packets, each containing 4 cookies and sold all the packets at \$2 each.

- (a) How many packets of cookies did he have?
- (b) How much money did he collect altogether?

Ans: (a) _____ [2]

(b) _____ [3]

47. 20% of the people at a book fair are boys. The number of girls is $\frac{1}{2}$ the number of boys. There are thrice as many women as girls. The number of men in the book fair is 177 more than the number of girls. How many people are there in the book fair altogether?

Ans: _____ [5]

13/

48. Klara, Rachel, Megan and Jane were given \$1800. Klara received 3 times as much money as Rachel. Megan received $\frac{1}{3}$ of the amount received by both Klara and Rachel. Jane received $\frac{1}{8}$ of the total amount of money received by Klara, Rachel and Megan.

- (a) How much money did Rachel receive?
- (b) What fraction of the total amount of money did Klara receive?

Ans: (a) _____ [3]

(b) _____ [2]

-END OF PAPER-

Have you checked your work thoroughly?

Rosyth Primary School
Primary 5 Maths CA2 Exam (2007)

Answer Keys

Q1	Q2	Q3	Q4	Q5
3	3	4	4	4
Q6	Q7	Q8	Q9	Q10
4	1	4	2	1
Q11	Q12	Q13	Q14	Q15
2	1	1	3	3

16. 2200
17. 3420
18. $\frac{1}{6}$
19. -
20. 62
21. 180°
22. 0.286
23. 2.88
24. 60%
25. 5kg
26. \$500
27. 66°
28. 135
29. 275 straws
30. \$2254
31. 300 animals
32. \$1.50
33. \$2080
34. 20%
35. 210 Malay books
36. $18.90 \div 1.00 = 18$
 $0.90 \div 0.40 = 2$
 $18 \times 3 = 54$
 $54 + 2 = 56$
The maximum number of books you can buy with \$18.90 is 56

37. $60 \times 2 = 1.20$
 $4.80 - 1.20 = 3.60$
 $3.60 \div 3 = 1.20$
 The price of an ice-cream is \$1.20

38. $\frac{7}{8} \times 176 = 154$
 $\frac{3}{4} \times 154 = 115.5\text{cm}$

39. $140 \times 3 = 420$
 $920 - 420 = 500$
 $500 \div 5 = 100$
 The average height of the other five children is 1m

40. $5\text{kg} = 0.85 \times 5 = \4.25 (Sugar)
 $8\text{kg} = 6.50 \times 8 = \52.00 (Rice)
 $\$(52 + 4.25) = \56.25
 She would have to pay \$56.25 for 5kg of sugar and 8kg of rice.

41. $48 \times 2 = 96$
 $96 - 84 = 12$
 $12 + 15 = 27$
 $27 + 40 = 67$
 Mark had 67 pencils at first.

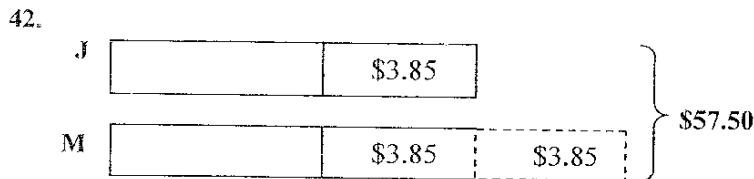

$3.85 \times 2 = \$7.70$

- a) Mary had \$7.70 more than John at first.
 b) $\$(57.50 - 7.70) = \49.80
 $\$49.80 \div 2 = \24.90
 John had \$24.90 at first.

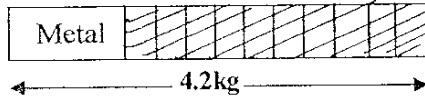
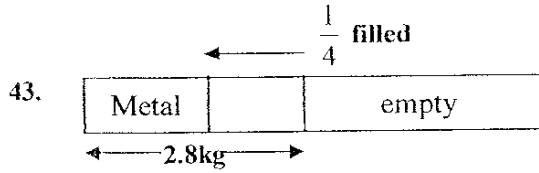

$$(4.2 - 2.8)\text{kg} = 1.4\text{kg}$$

$$1.4\text{kg} \div 7 = 0.2$$

$$0.2 \times 3 = 0.6$$

$$2.8 - 0.6 = 2.2\text{kg}$$

The weight of the metal container is 2.2kg

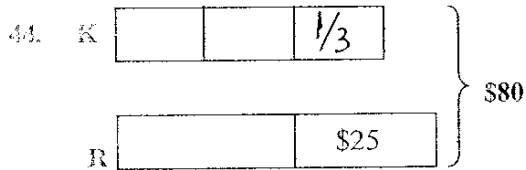

$$80 - 25 = 55$$

$$55 \div 5 = 11$$

$$11 \times 2 = 22$$

$$22 + 25 = 47$$

Rebecca had \$47 at first.

45. $212 - 92 = 120$

$$120 \div 3 = 40$$

$$3c = 40 \times 3 = 120$$

$$2+ = 40 \times 8 = 320$$

$$1c = 52 + 440 = 492$$

She spent \$492 altogether.

46a. $800 \div 10 = 80$

$$80 \times 6 = 480$$

$$480 \times 0.40 = 192.00$$

$$800 - 480 = 320$$

$$320 \div 4 = 80$$

He had 80 packets of cookies

46b. $80 \times 2 = 160$

$$192 + 160 = 352$$

He collected \$352 altogether.

47. $4u - 1u = 3u$

$$177 \div 3 = 59$$

$$59 \times 10 = 590$$

There were 590 people in the book fair.

48a. $1800 \div 18 = 100$

$$100 \times 3 = 300$$

Rachel received \$300

48b. $100 \times 9 = 900$

$$\frac{900}{1800} = \frac{1}{2}$$

She received $\frac{1}{2}$ of the total amount.