

**NAN HUA PRIMARY SCHOOL
END OF YEAR EXAMINATIONS 2007
PRIMARY FOUR
SCIENCE**

Name : _____ ()

Class : Primary 4 / _____

Date : 29 October 2007

Duration : 1 hr 45 min

MARKS	
Sect A:	/ 60
Sect B:	/ 40
Total :	/ 100

Parent's Signature : _____

Section A: (30 x 2marks = 60marks)

For each question from 1 to 30, four options are given. One of them is the correct answer. Make your choice (1, 2, 3 or 4). Shade the correct oval (1, 2, 3 or 4) on the Optical Answer Sheet.

1. Which one of the following is not matter?

- (1) Ink
- (2) Clay
- (3) Sound
- (4) Water vapour

2. Which one of the following correctly describes the water cycle?

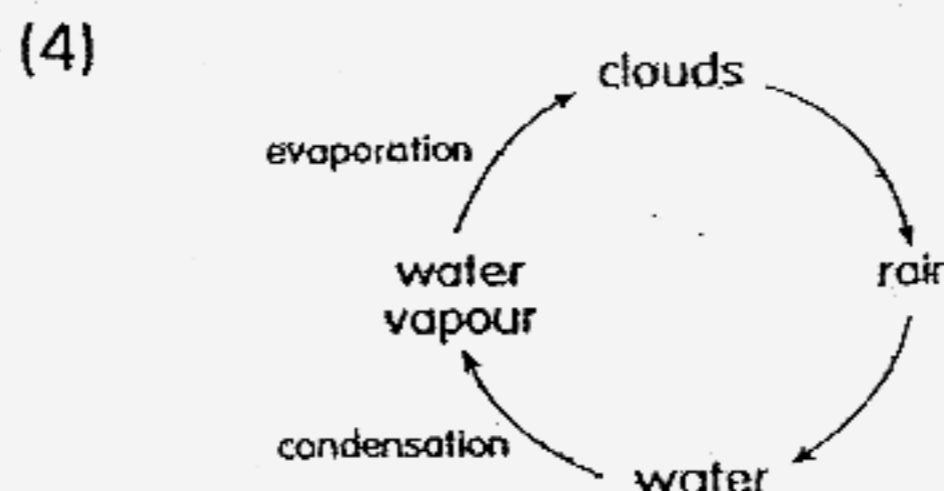
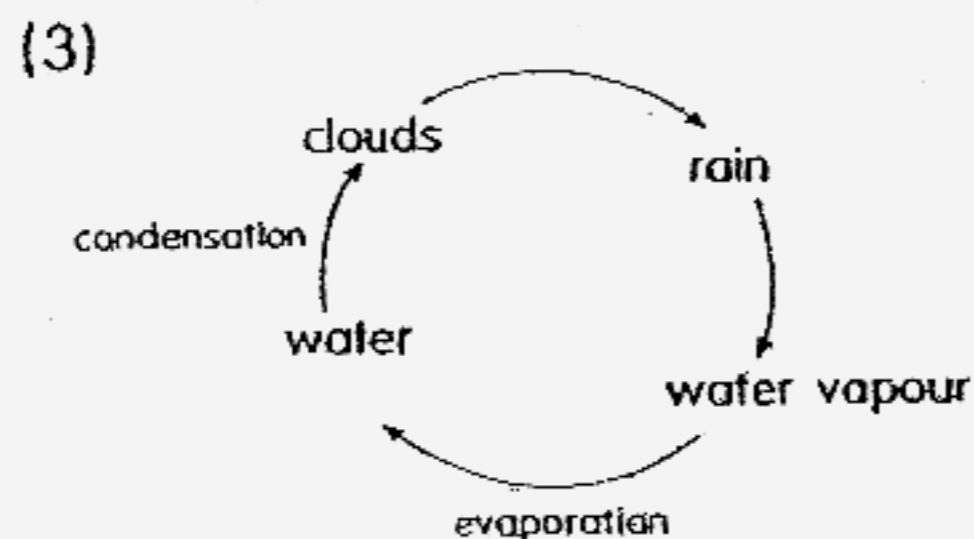
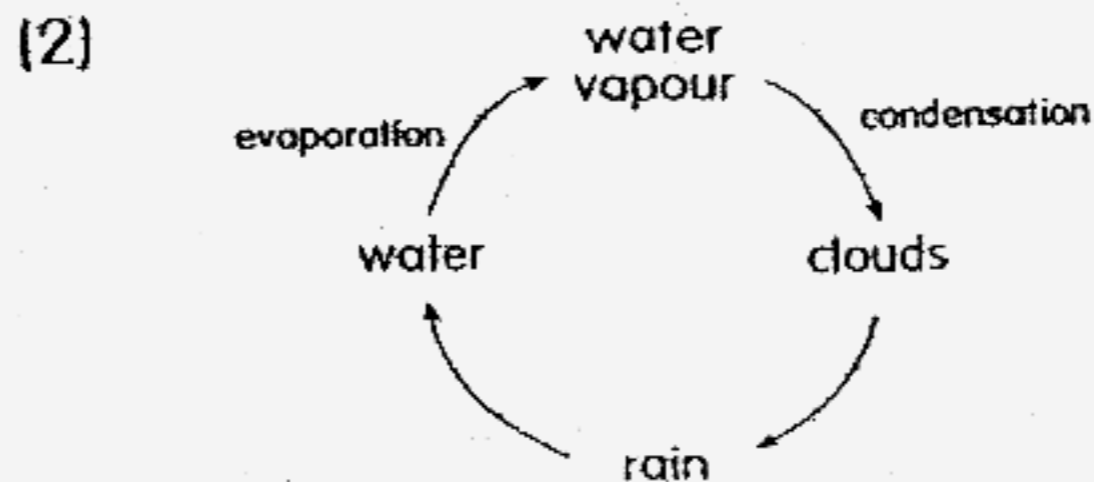
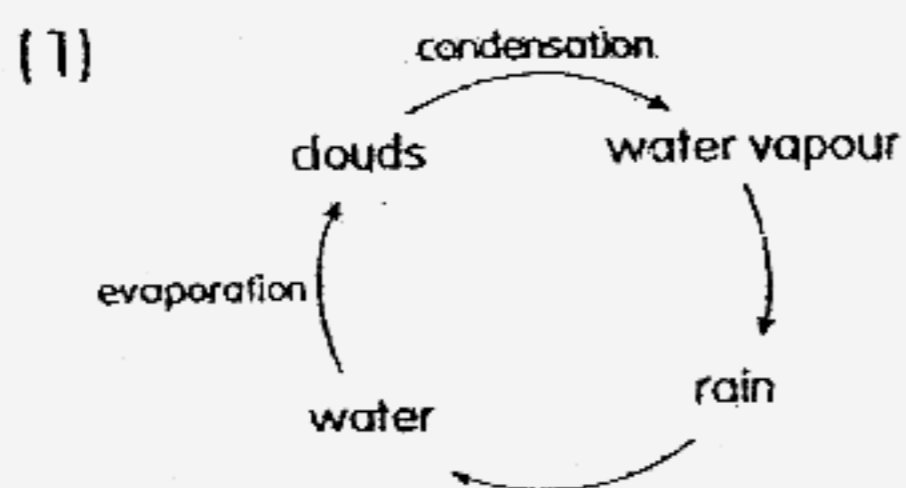

3. We can help to conserve water by _____.

- (1) taking a long bath instead of a quick shower
- (2) leaving the tap on when washing the dishes
- (3) using a hose instead of a bucket to wash the car
- (4) repairing leaks in taps immediately when they occur

4. Which one of the following shows the correct composition of gases in the air?

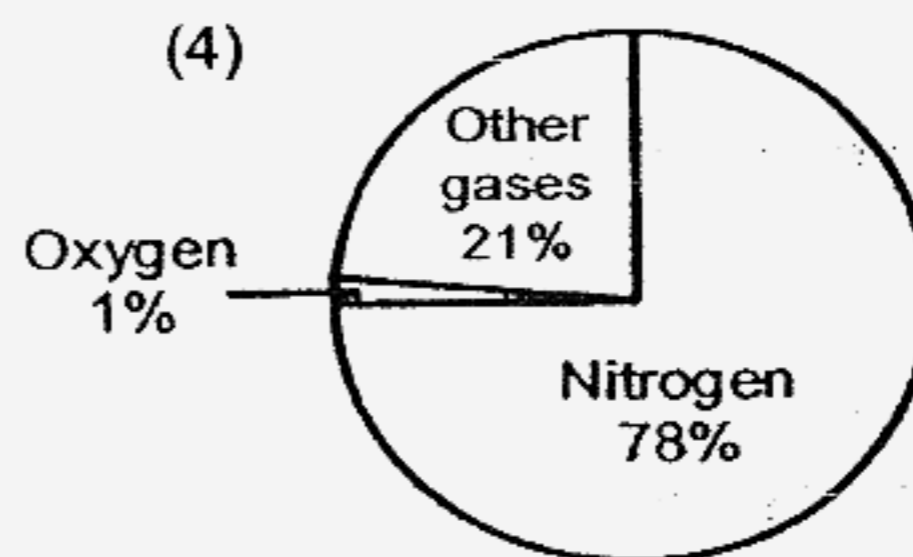
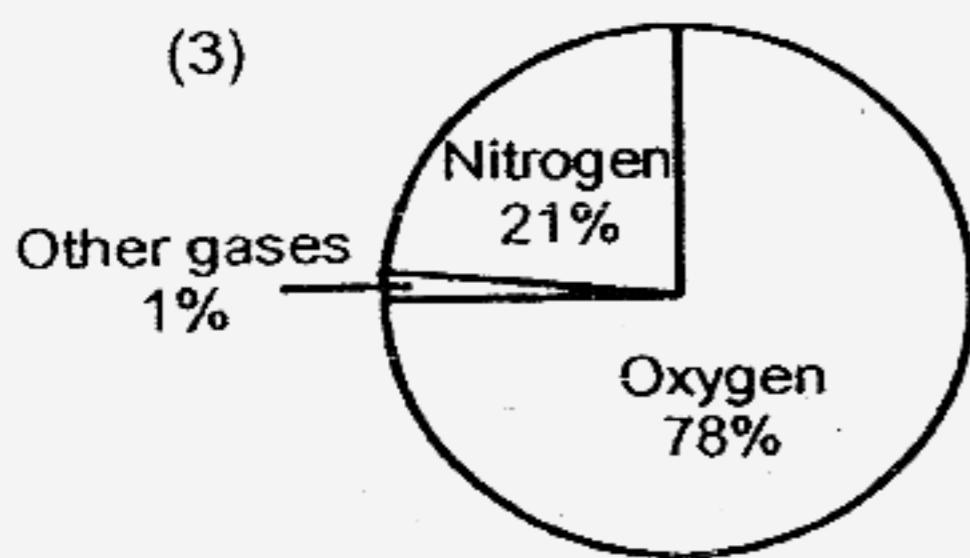
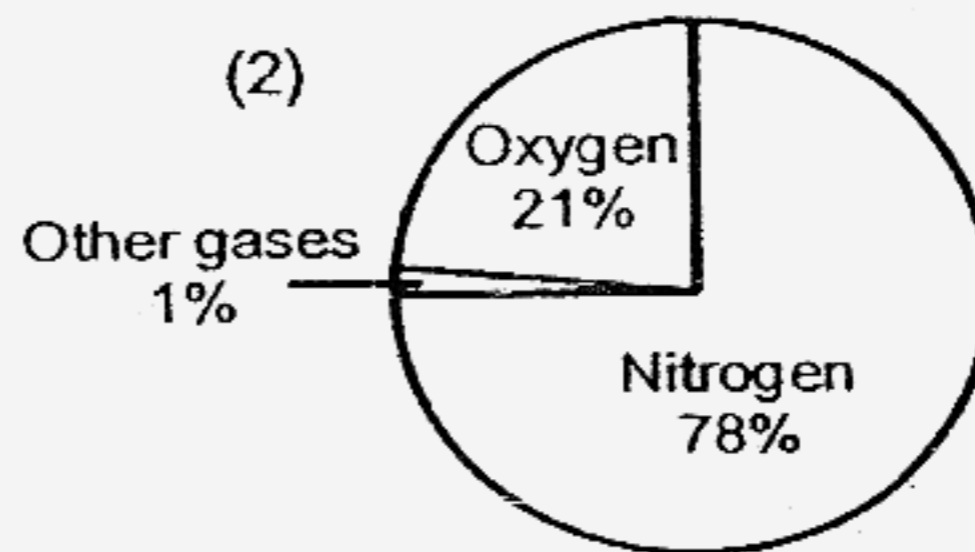
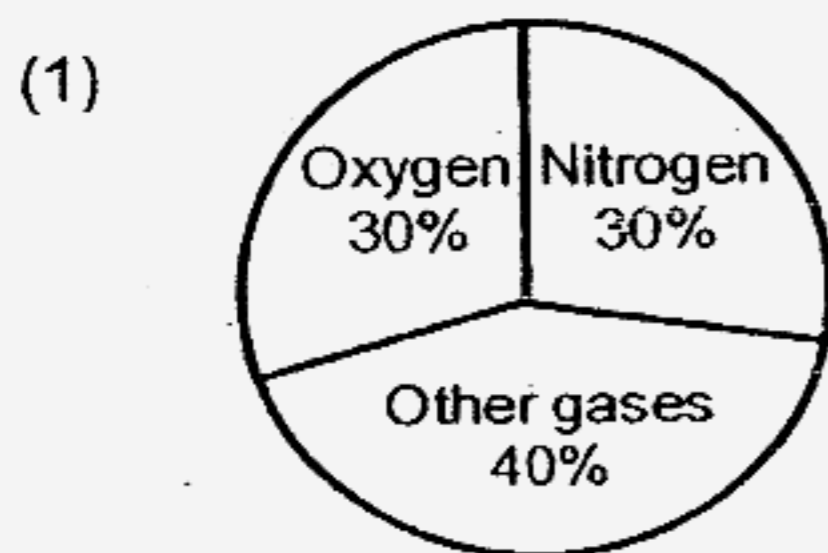

5. Which one of the following shows the correct path in which oxygen is transported around our body?

- (1) Windpipe → Lungs → Heart → Rest of the body
- (2) Lungs → Heart → Windpipe → Rest of the body
- (3) Heart → Lungs → Windpipe → Rest of the body
- (4) Windpipe → Heart → Lungs → Rest of the body

6. Which one of the following does **not** contain stored energy?

- (1) Food
- (2) Wood
- (3) Glass
- (4) Petrol

7. Which one of the following objects does not allow any light to pass through?

- (1) Mirror
- (2) Glass bottle
- (3) Tracing paper
- (4) Clear plastic sheet

8. Sarah set up the experiment shown below. She used some wax to attach 4 thumbtacks A, B, C and D to the iron rod. She lit the candle and held it near the iron rod at the part marked X. Which one of the following shows the correct order in which the thumbtacks will drop from the iron rod?

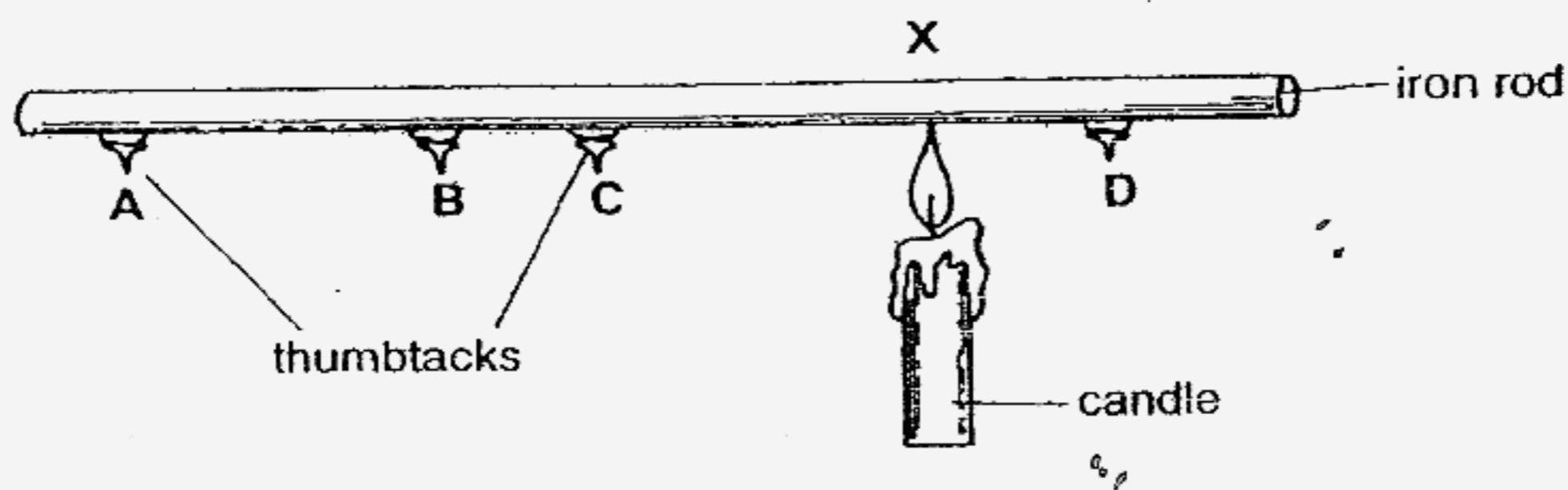

- (1) A, B, C, D
- (2) B, C, A, D
- (3) C, B, D, A
- (4) D, C, B, A

9. Which one of the following spoons heats up the fastest when placed in a cup of hot porridge?

- (1) A metal spoon
- (2) A plastic spoon
- (3) A wooden spoon
- (4) A porcelain spoon

10. Which one of the following statements is **false**?

- (1) Our skeletal system supports the body and keeps it in shape.
- (2) Our digestive system breaks down food into simpler substances for the body to absorb
- (3) Our blood circulatory system carries food, oxygen, water and waste materials to and from various parts of the body.
- (4) Our respiratory system takes in carbon dioxide needed by the body from the air and gives out unwanted oxygen from the body into the air.

11. The diagram below shows a human arm. When we bend our arms in the direction shown by the arrow, which of the following takes place?

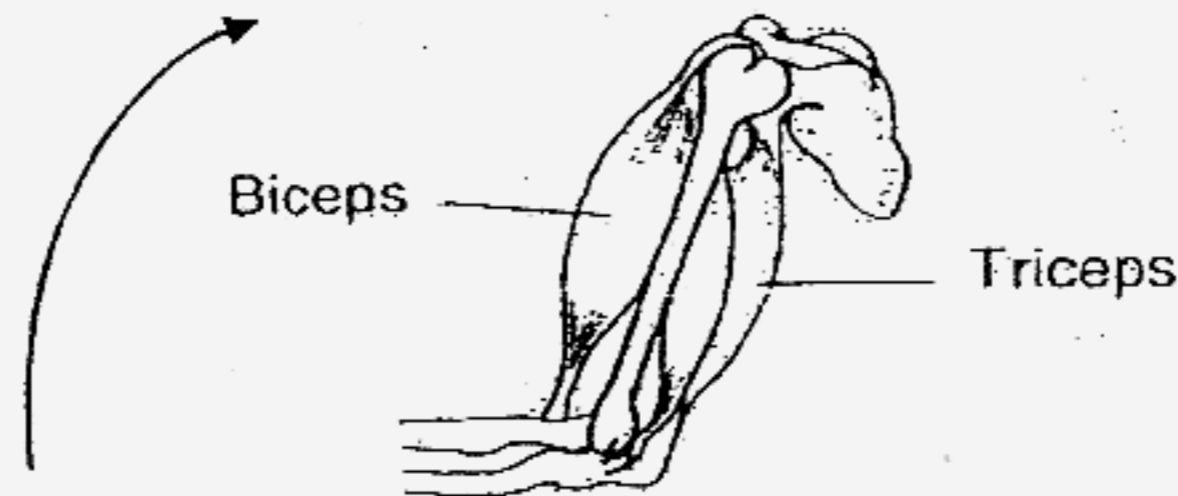

- A. Our biceps contract
- B. Our triceps contract
- C. Our biceps relax
- D. Our triceps relax

- (1) A only
- (2) A and B only
- (3) B and C only
- (4) A and D only

12. You can make a magnet by _____.

- (1) heating an iron nail
- (2) touching a steel pin with a compass
- (3) stroking a steel rod with a bar magnet
- (4) coiling an iron bar with steel wire

13. Reuben took an empty glass, inverted it and pushed it into a basin of water as shown in the picture below. He noticed that a small amount of water entered the glass. What does this show?

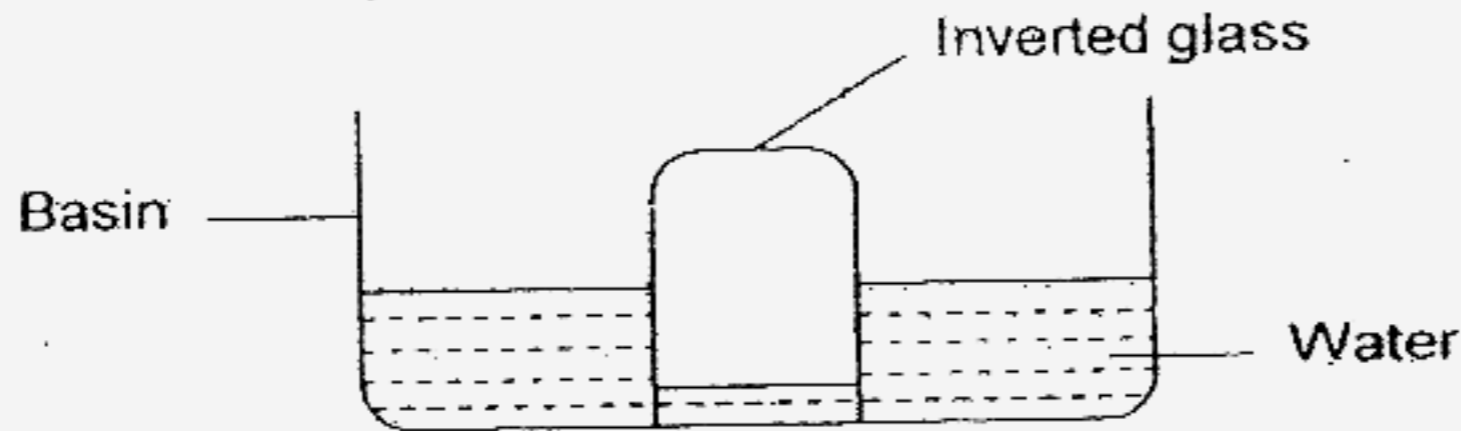

- (1) Air can flow
 (2) Air has mass
 (3) Air has a definite volume
 (4) Air can be compressed
14. Ivy placed some ice cubes in a beaker. She heated the beaker of ice cubes for 30 minutes. She plotted the graph below to show the temperature changes of the contents in the beaker over a period of time.

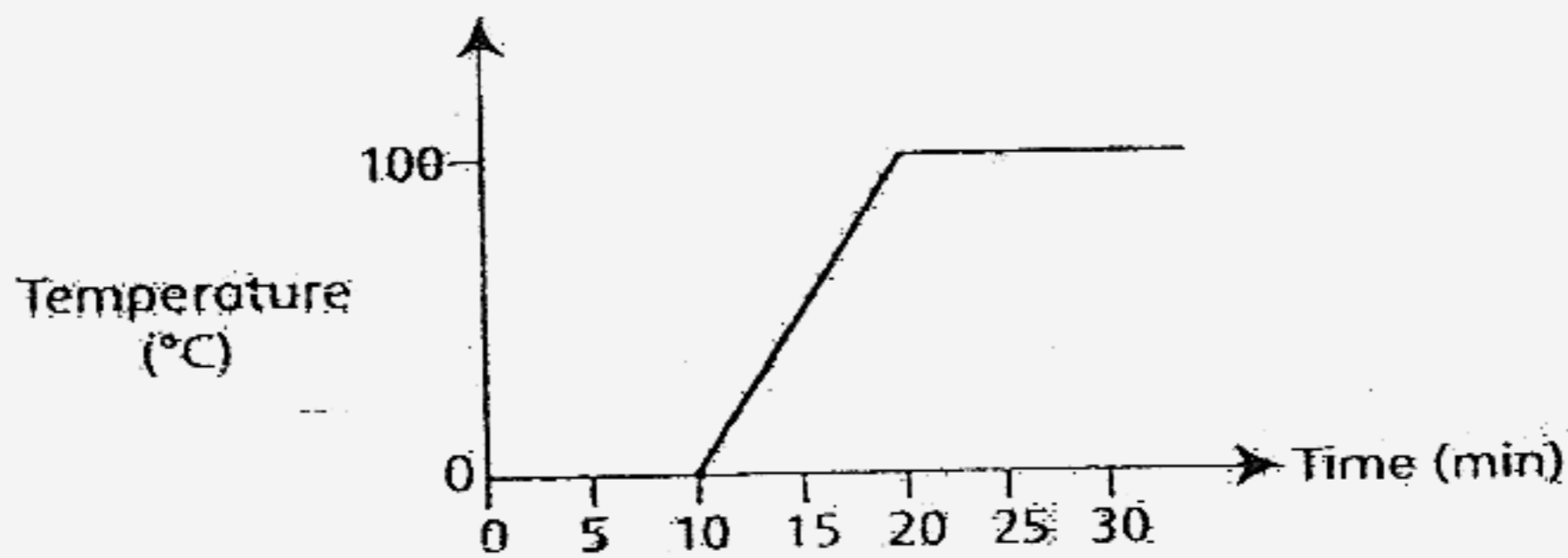

What processes are taking place in her setup at the 5th and 25th minute?

	At the 5 th minute	At the 25 th minute
(1)	Freezing	Condensation
(2)	Freezing	Boiling
(3)	Evaporation	Condensation
(4)	Melting	Boiling

15. Joshua noticed a puddle of water on the assembly ground. Which one of the following **does not** affect the rate of evaporation of the puddle of water?
- (1) Humidity
 - (2) Presence of wind
 - (3) Colour of the water
 - (4) Exposed surface area of the puddle

16. Two identical fish tank set-ups, P and Q, were placed beside each other in the same room as shown in the picture below.

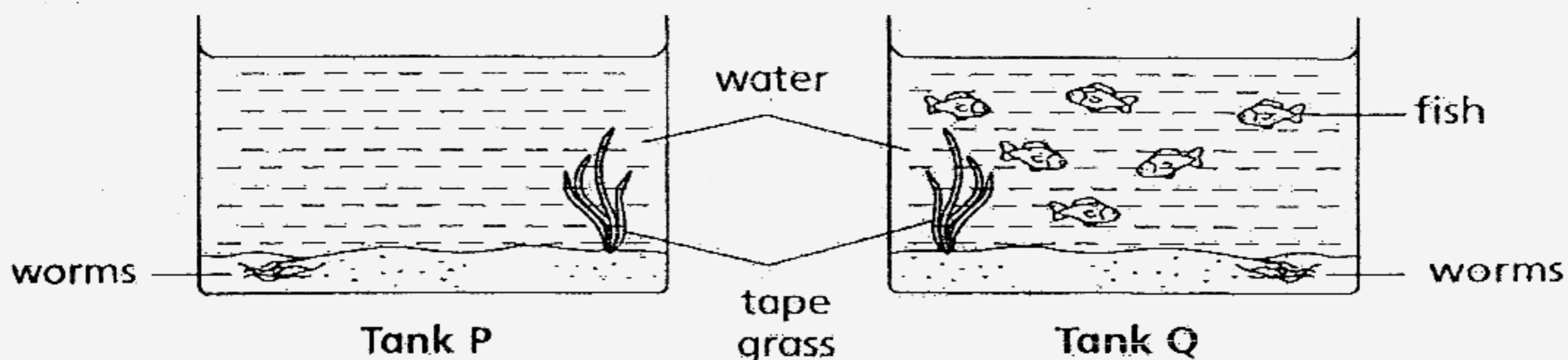

After two weeks, it was observed that the tape grass in tank Q had grown taller than the one in tank P. Which of the following are possible reasons for this observation?

- A. The fish in tank Q provided carbon dioxide for the tape grass to make food.
- B. The tape grass in tank P did not receive any sunlight.
- C. The droppings from the fish provided nutrients for the tape grass in tank Q.
- D. The water in tank Q had a higher temperature than the water in tank P.

- (1) A and C
- (2) B and D
- (3) A, B and D
- (4) A, B, C and D

17. A school bus is packed full of students and the air conditioner is not working. After some time, the students in the bus complain that they are feeling humid and faint. Which of the following best describes the changes in the composition of air in the bus?

	Carbon dioxide	Oxygen	Water Vapour
(1)	Increase	Decrease	No change
(2)	Decrease	Increase	Decrease
(3)	Increase	Decrease	Increase
(4)	Decrease	No change	Decrease

18. Grace placed a young balsam plant in a beaker of water containing red dye. She placed the set-up in the sun for a day and observed that the leaves and the stem were stained red. What could she conclude from the observation?

- A. The roots of the plant take in water.
- B. The phloem tubes carry food from the roots to the leaves.
- C. During photosynthesis, the leaves make food that is coloured red.
- D. The stem of the plant carries water from the roots to the leaves.

- (1) A and B
- (2) A and D
- (3) A, B and D
- (4) A, B, C and D

19. The table below shows Ming Long's pulse rate and number of breaths while at rest.

Pulse rate	Number of breaths (per minute)
70	40

Which one of the following best shows Ming Long's pulse rate and number of breaths after running for 20 minutes?

	Pulse rate	Number of breaths (per minute)
(1)	50	30
(2)	50	60
(3)	110	30
(4)	110	60

20. Which of the following are similarities between the plant and the human circulatory system?

- A. Both systems have tubes to transport materials.
- B. Both systems transport food, oxygen and carbon dioxide.
- C. Both systems perform the function of transporting materials.
- D. Both systems use an organ to pump the materials through the tubes.

- (1) A and B
- (2) A and C
- (3) A, B and C
- (4) A, B and D

21. Study the table showing the activities of four boys.

Name of boy	Activity
Alden	Walking in the park
Bernard	Watching television
Christopher	Running a race
Darren	Sleeping

Which boy used the most energy?

- (1) Alden
- (2) Bernard
- (3) Christopher
- (4) Darren

22. A ball was placed in the middle of a cardboard box as shown in the figure below. Four tubes, A, B, C and D were placed in the box. Which of the tubes can be used to view the ball?

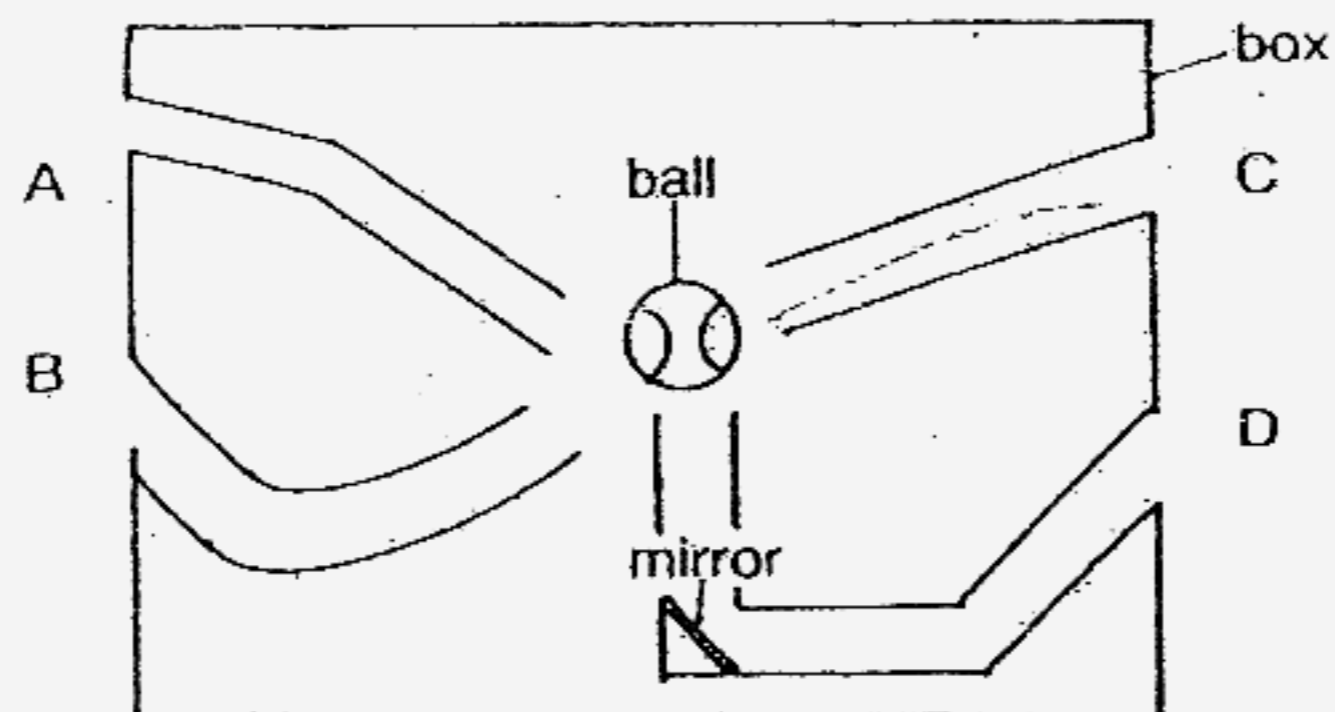

- (1) A
 (2) B
 (3) C
 (4) D
23. Aleena has four sheets made of different materials as shown in the diagram below. She arranged the sheets, S, T, U and V in a straight line. When the torch is switched on, a small, bright circular patch of light is seen on Sheet T only. Which one of the following best describes the properties of the materials of sheets S, T, U and V?

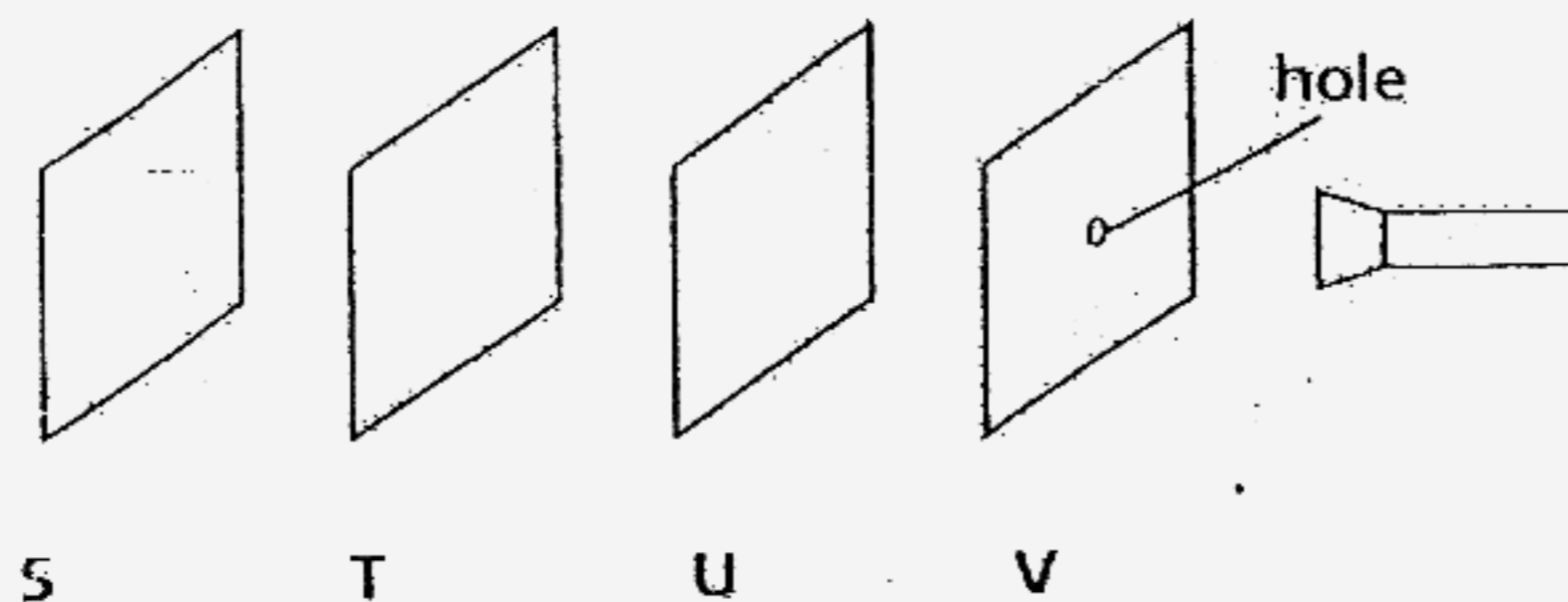

	Allows light to pass through	Does not allow light to pass through	Not possible to tell
(1)	T and V	U	S
(2)	S and U	V	T
(3)	U	T and V	S
(4)	V	T	S and U

24. When the metal ball is heated, its _____

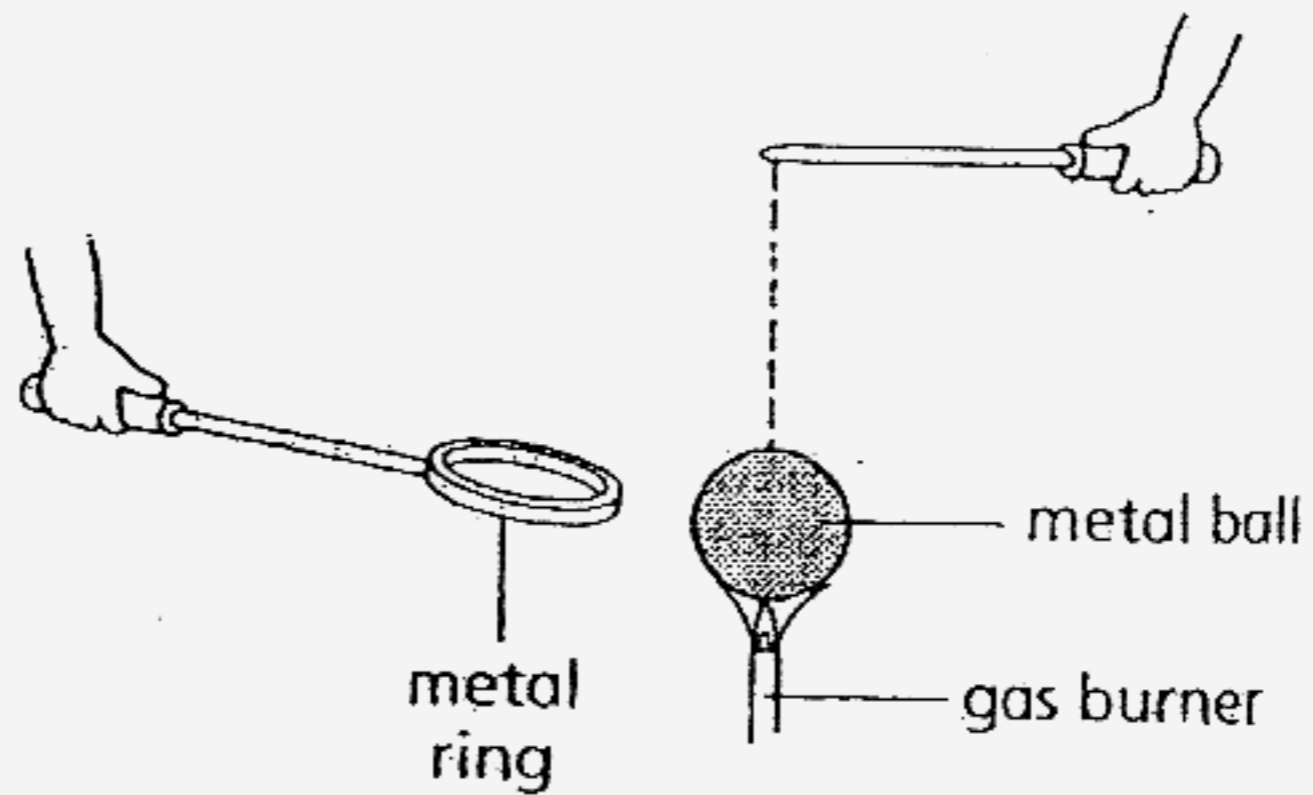

- A. temperature rises ✓
- B. volume increases ✓
- C. volume decreases ✗
- D. temperature falls ✗

- (1) A and B
- (2) B and C
- (3) B and D
- (4) C and D

25. A bottle of cold milk was placed in a mug containing hot water. Which of the following statements are correct?

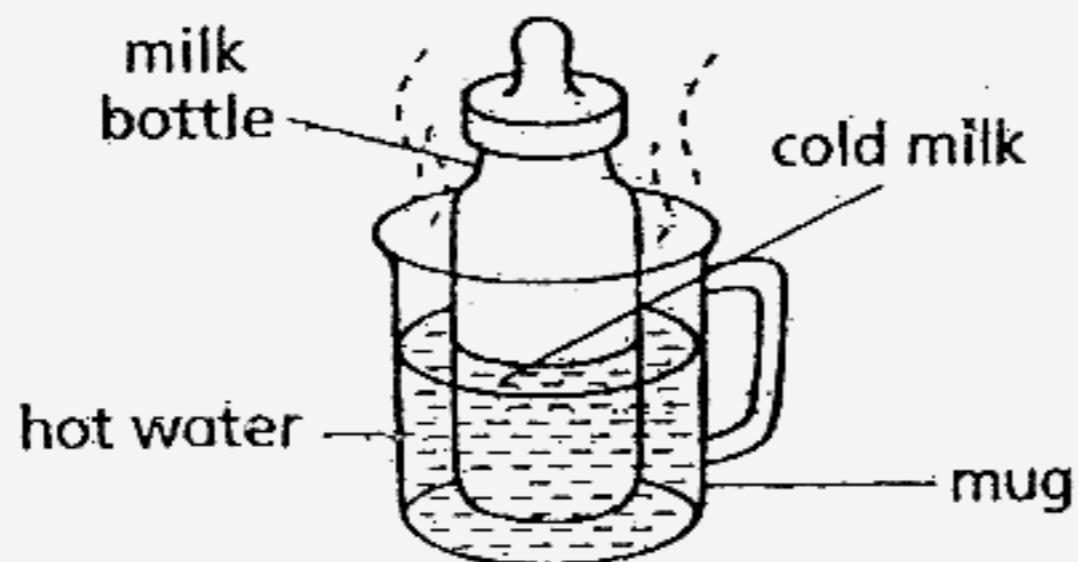

- A. The cold milk loses heat
- B. The temperature of the hot water falls
- C. The mug gains heat from the hot water.
- D. The hot water gains heat from the cold milk

- (1) A and B
- (2) A and D
- (3) B and C
- (4) C and D

26. Two of Andria's metal cups are stuck together as shown below.



Which one of the following would be the most suitable method of separating them?

(1)

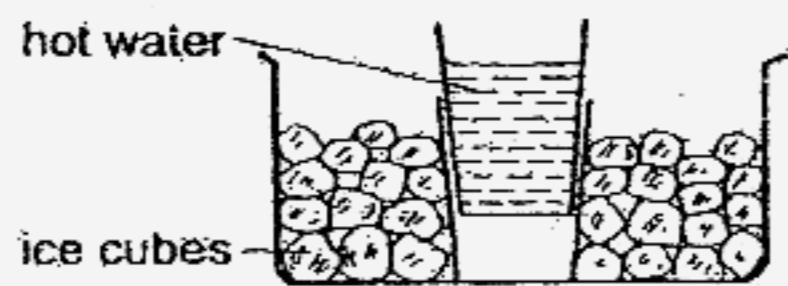

(2)

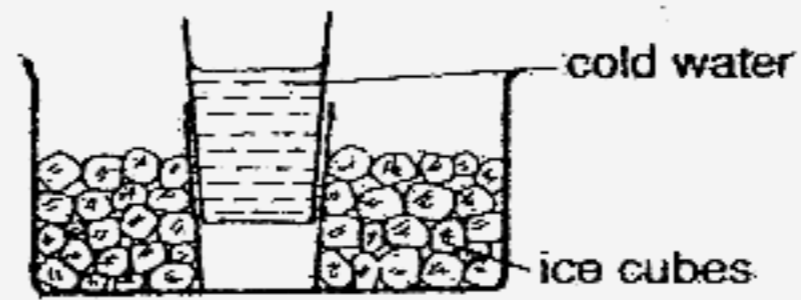

(3)

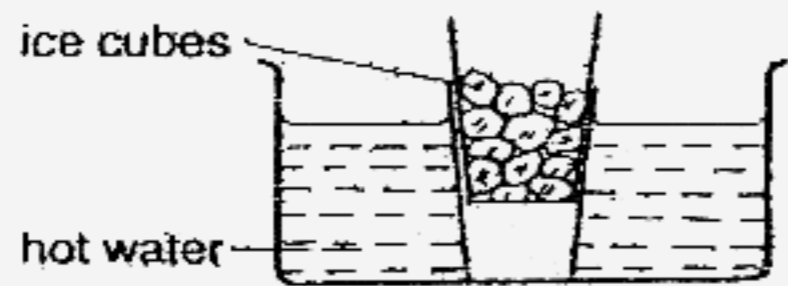

(4)

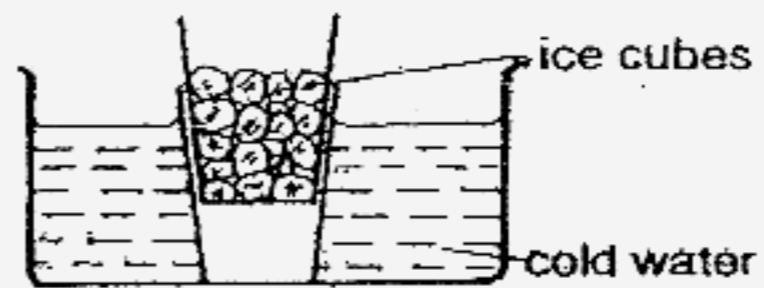

27. Four cans made of different materials were filled with tap water and placed on a hot plate at 80°C for 5 minutes as shown below. A thermometer was placed in each can. At the end of the 5 minutes, which thermometer would show the highest reading?

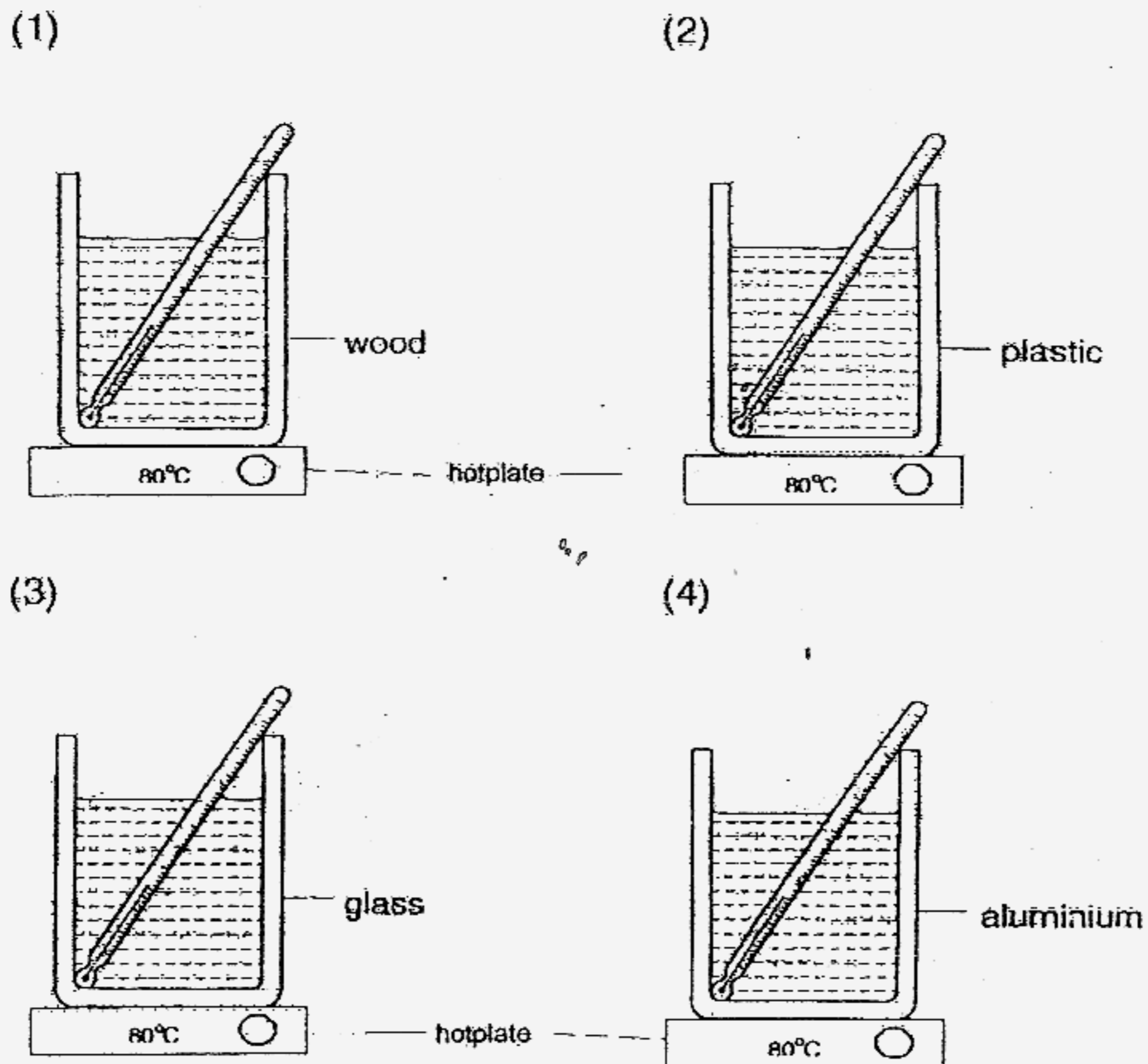

28. Aminah was told to take care of a balsam plant. She watered the balsam plant every day and protected the plant by placing it in a dark cupboard. Which one of the following statements below **best** describes what will happen to the balsam plant after **one month**?

- (1) The balsam plant will start to bear fruits.
- (2) The balsam plant will look weak due to a lack of oxygen.
- (3) The balsam plant will die due to a lack of carbon dioxide.
- (4) The balsam plant will die because it could not make food.

29. The diagram below shows the human body. In which parts of the body does digestion take place?

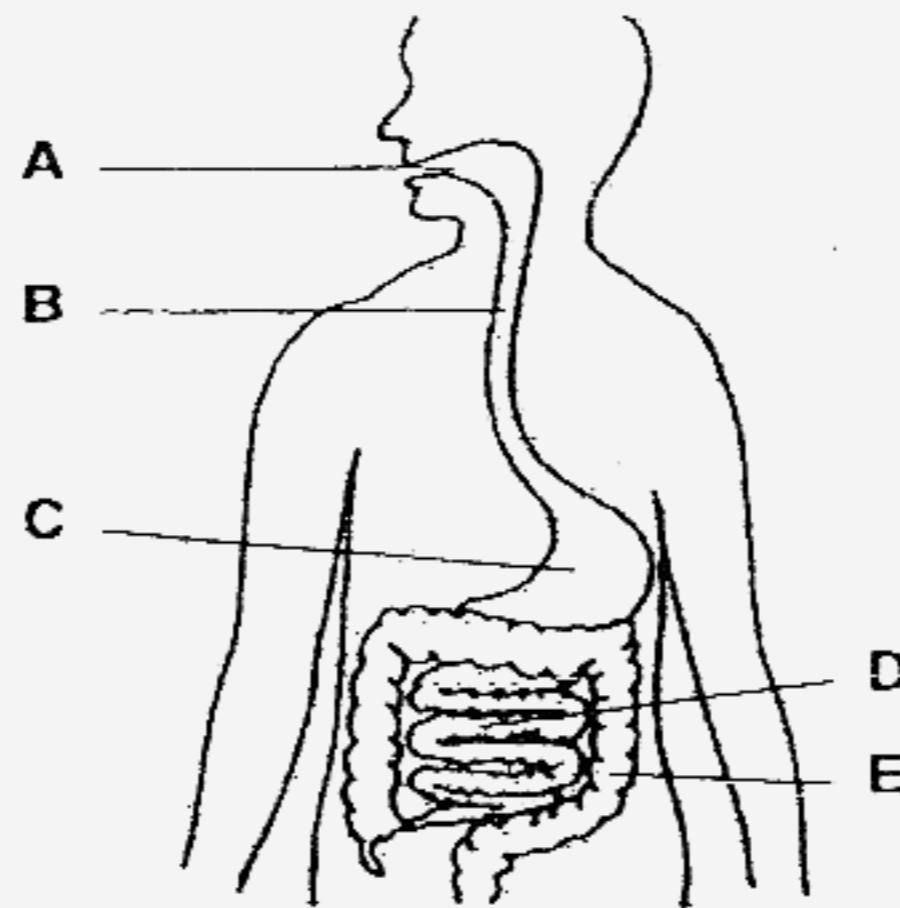

- (1) A and C only
 (2) A, B and C only
 (3) A, C and D only
 (4) A, C, D and E only
30. Raphael found 3 objects and wanted to test if they were magnets. He bought a magnet from the school bookshop and placed it next to each of the objects. This is what he observed.

Object	Observation
Object A	No reaction
Object B	Repels
Object C	Attracts

Which of the following object(s) is **definitely** a magnet?

- (1) Object A
 (2) Object B
 (3) Object C
 (4) Objects B and C

**NAN HUA PRIMARY SCHOOL
END OF YEAR EXAMINATION 2007
PRIMARY FOUR
SCIENCE**

Name : _____ ()

Class : Primary 4 / _____

MARKS	
	40

Section B: (40marks)

Write your answers to question 31 to 46.

The number of marks available is shown in brackets [] at the end of each question or part question.

31(a) Jeri wanted to find out what will happen to the water inside her bottle when she tilts it. Diagram A shows her water bottle partially filled with water. She then tilts her bottle slightly as shown in diagram B. Then, the bottle is made to lie sideways on the table as shown in diagram C.

Using a ruler, draw the changes in the water level which Jeri will observe in diagrams B and C.

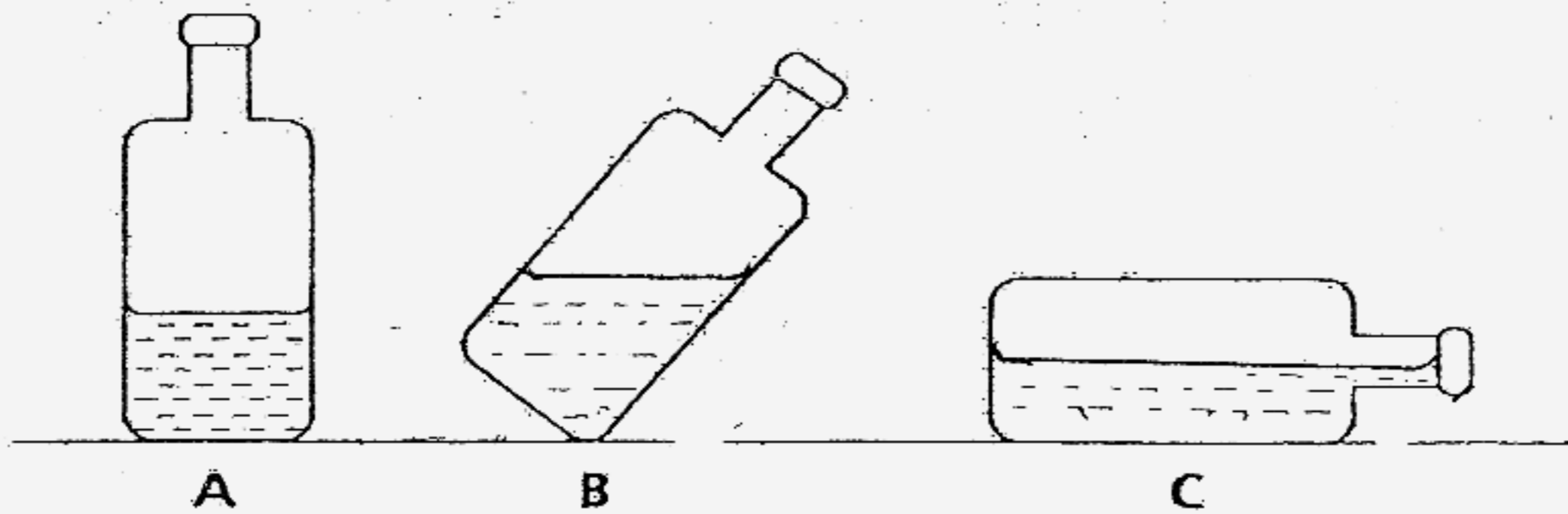

[1]

(b) Based on the above experiment, what can you infer about the property of the liquids? [1]

Score	2
--------------	----------

32. Study the diagram below.

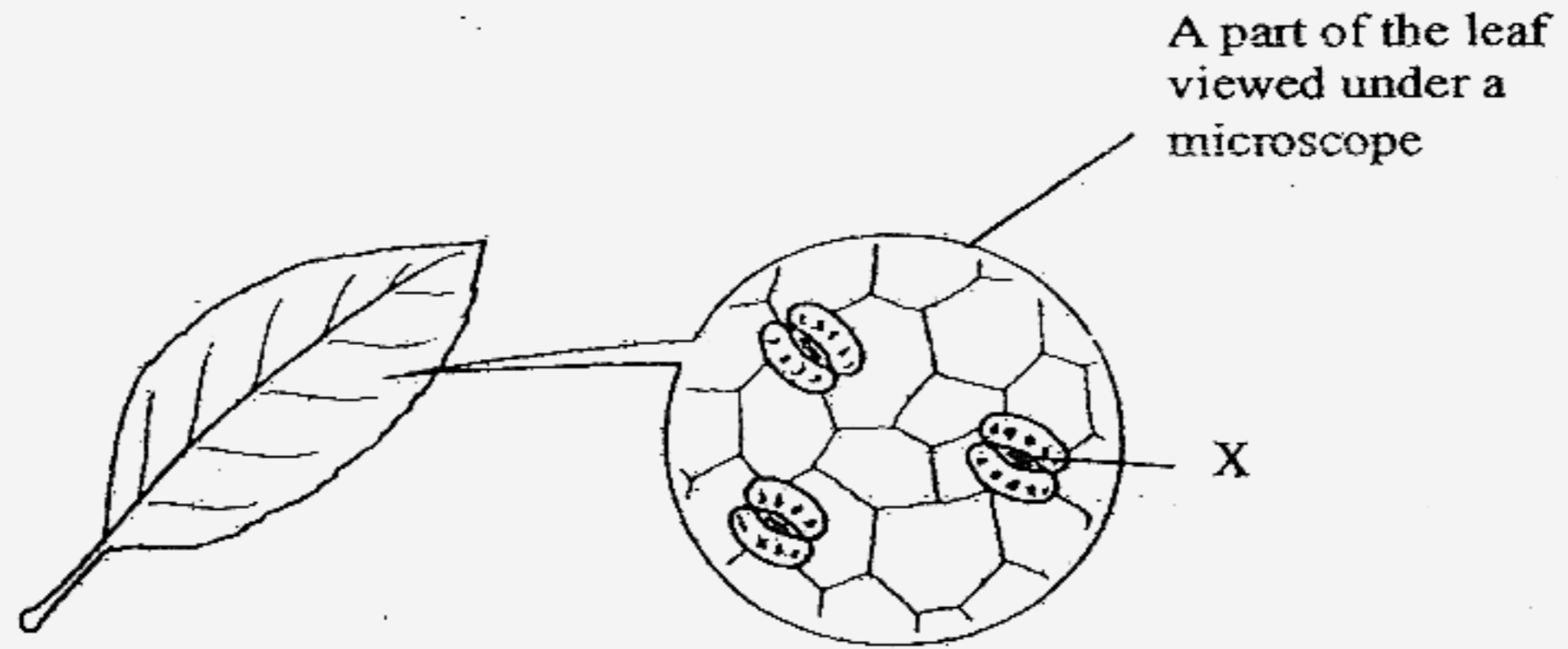

(a) Name the part of the leaf labelled X

[1]

(b) What function does the part labelled X perform **during photosynthesis**?

[2]

Score	3
-------	---

33. The diagram below shows how blood flows in the human body.

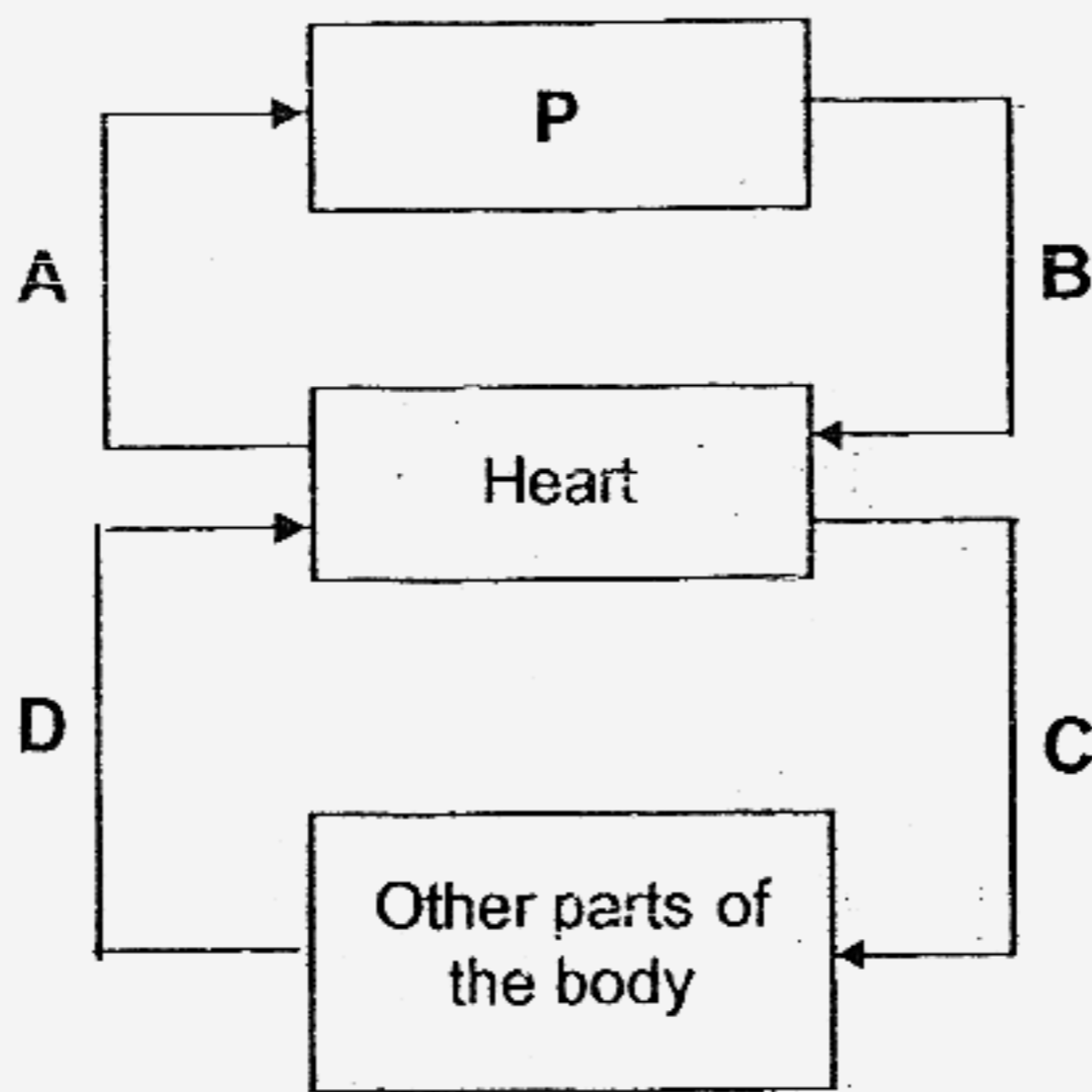

The blood at B contains more oxygen than the blood at A

(a) Name the organ P. [1]

(b) Why is the amount of carbon dioxide in the blood higher at D than at C? [1]

34 (a) Study the diagrams of thermometers, A, B, C and D, below and record their readings in the space provided.

[2]

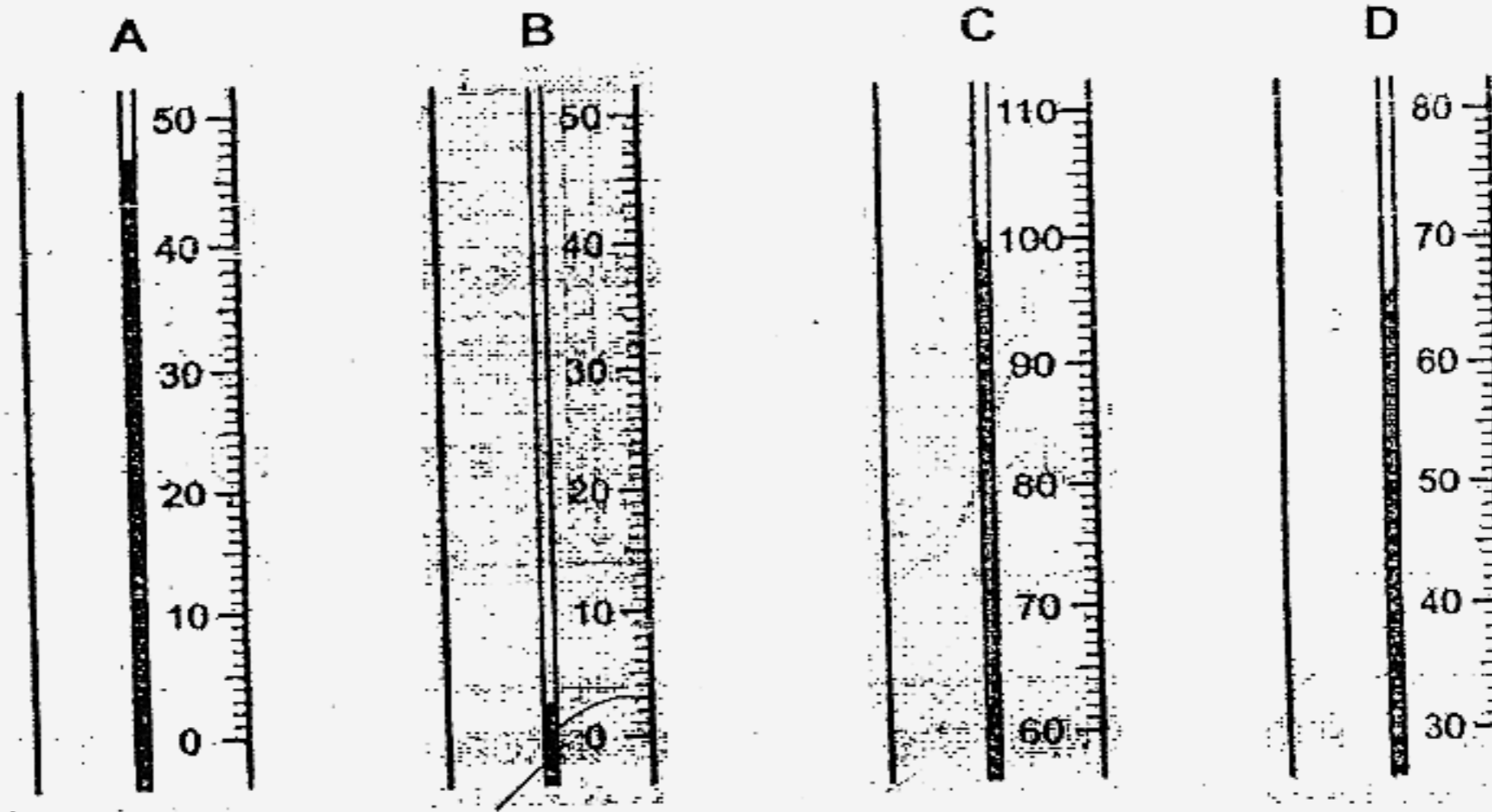

Readings: _____ °C

_____ °C

_____ °C

_____ °C

(b) Which of the thermometers shows the temperature of boiling water?

[1]

Score	3
-------	---

35. Clarice placed a wooden box containing a plant in the open where there was sufficient sunlight. The plant is healthy and is watered daily.

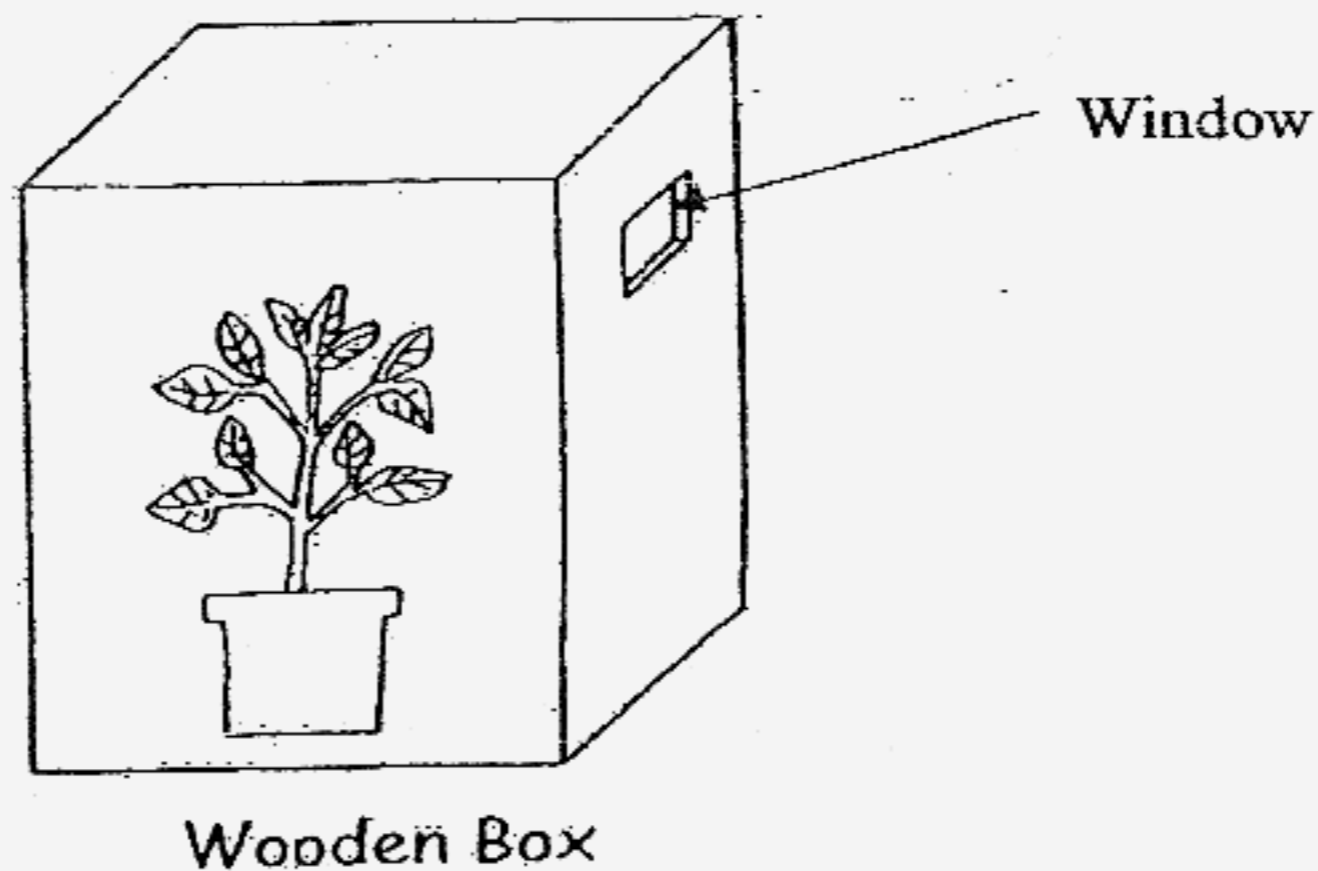

- (a) What will happen to the plant after one week?

[1]

- (b) Give a reason for your answer in (a).

[1]

Score	
-------	---

36. Study the body parts below.
Circle the body parts that belong to the **digestive system**.

Gullet	Stomach	Mouth	Arteries
Skin	Lungs	Small intestine	Heart

[2]

37. A mixture of sand, salt and water was heated as shown below. The mixture was brought to a boil. After a few minutes, liquid M was formed on the underside of the glass sheet.

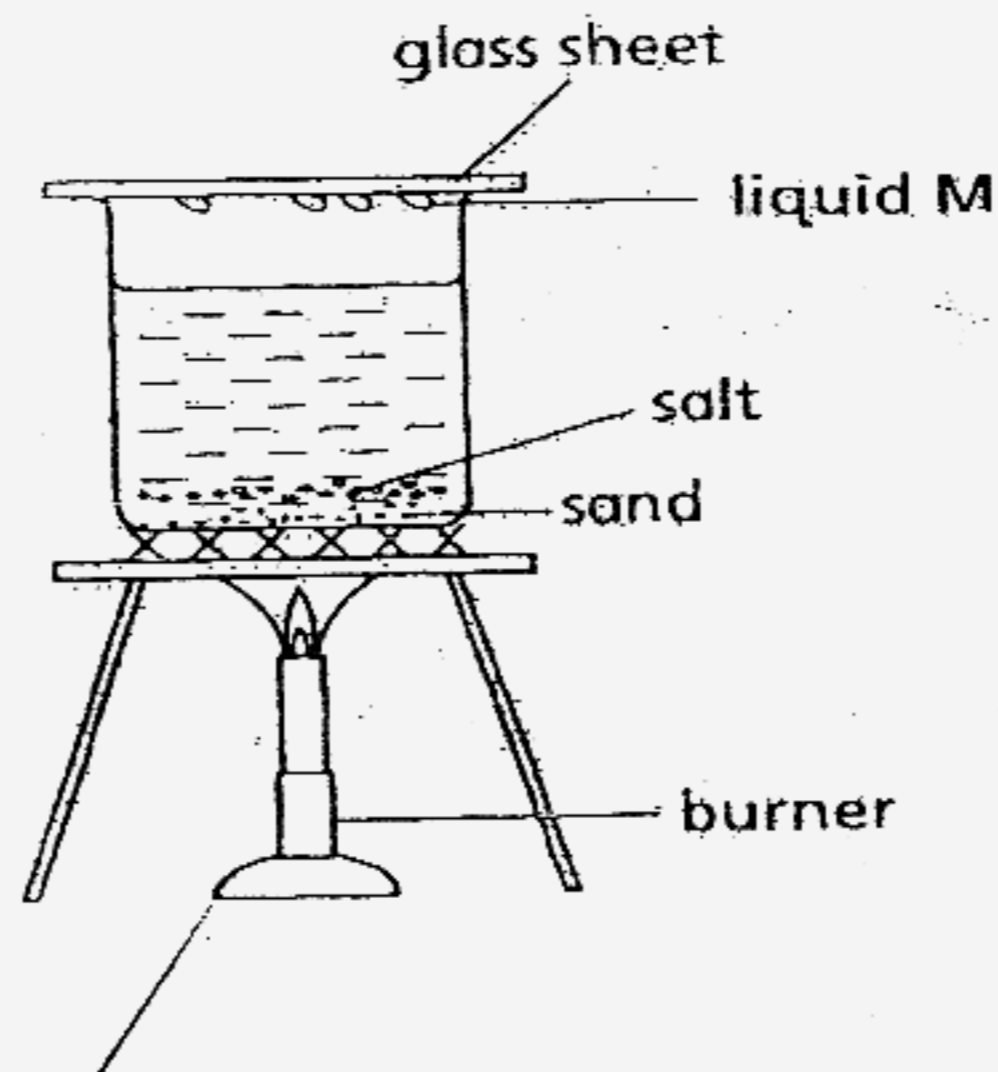

- (a) What is liquid M?

[1]

- (b) Explain how liquid M was formed.

[2]

Score	5
-------	---

38(a) There are tiny and fine hairs in the nostrils of humans as shown in the figure below.



What is the function of these tiny hairs?

[1]

(b) Claire built a model of the human respiratory system as shown in the figure below. State what each of the components of the model represents.

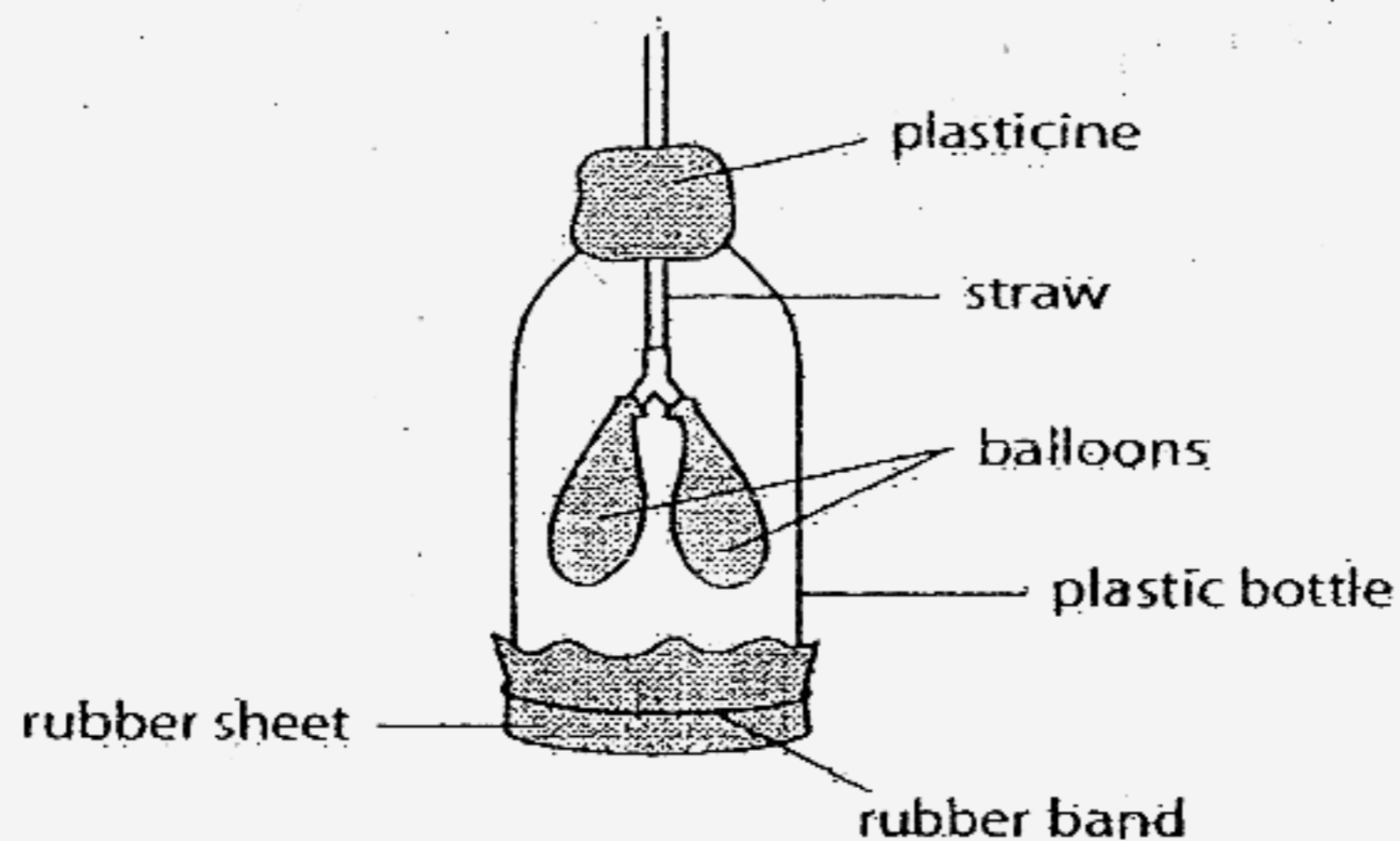

(i) balloons: _____

(ii) straw: _____

(iii) rubber sheet: _____

(iv) plastic bottle: _____

[2]

Score	3
-------	---

39(a) The figure below shows the cross section of a sunflower stem.

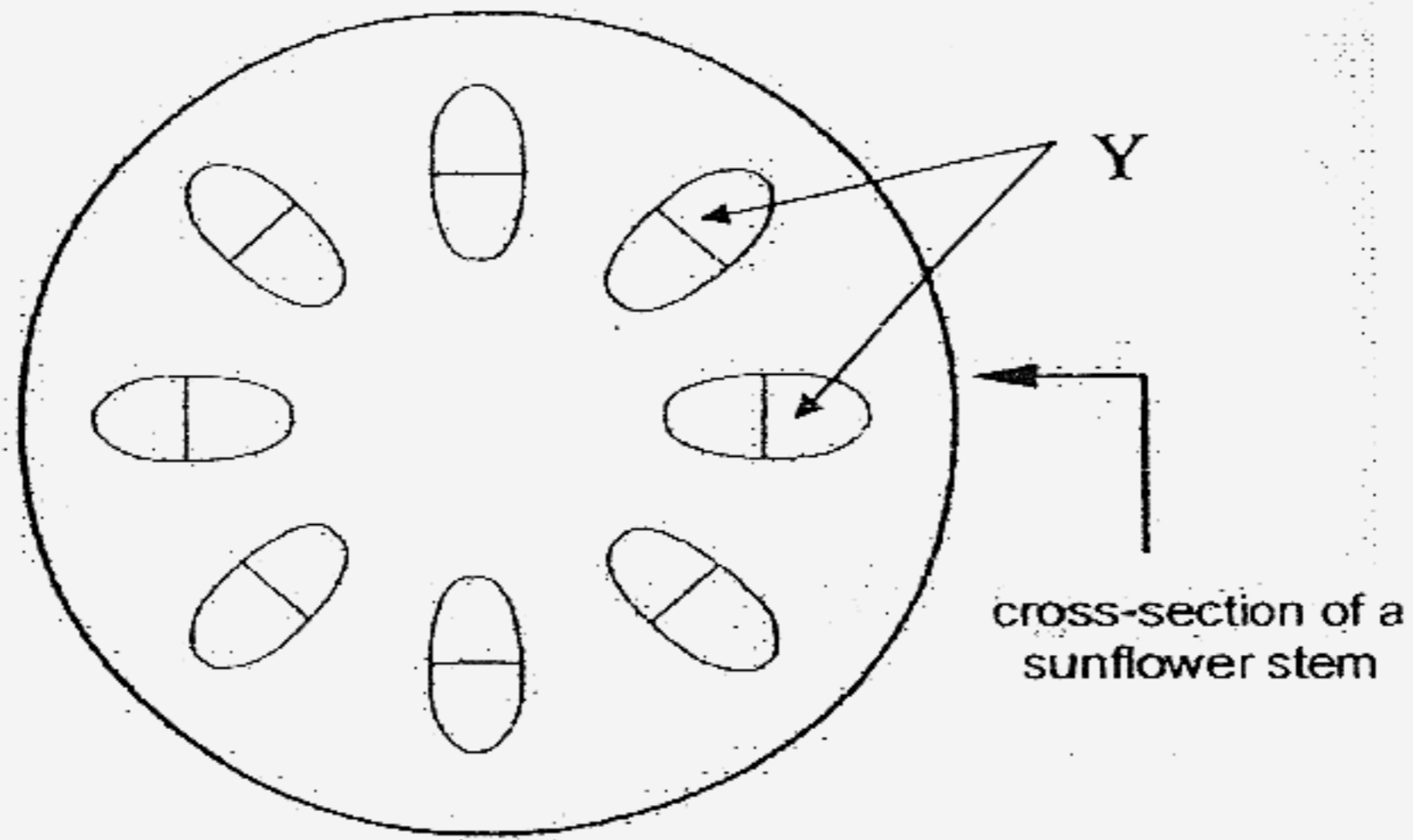

What is the function of the parts labelled Y?

[1]

Score	1
-------	---

39(b) Hui Ling poured 300 ml of water into four beakers and placed four balsam plants, A, B, C and D into them as shown in the figure below. A thin layer of oil was poured on the surface of the water.

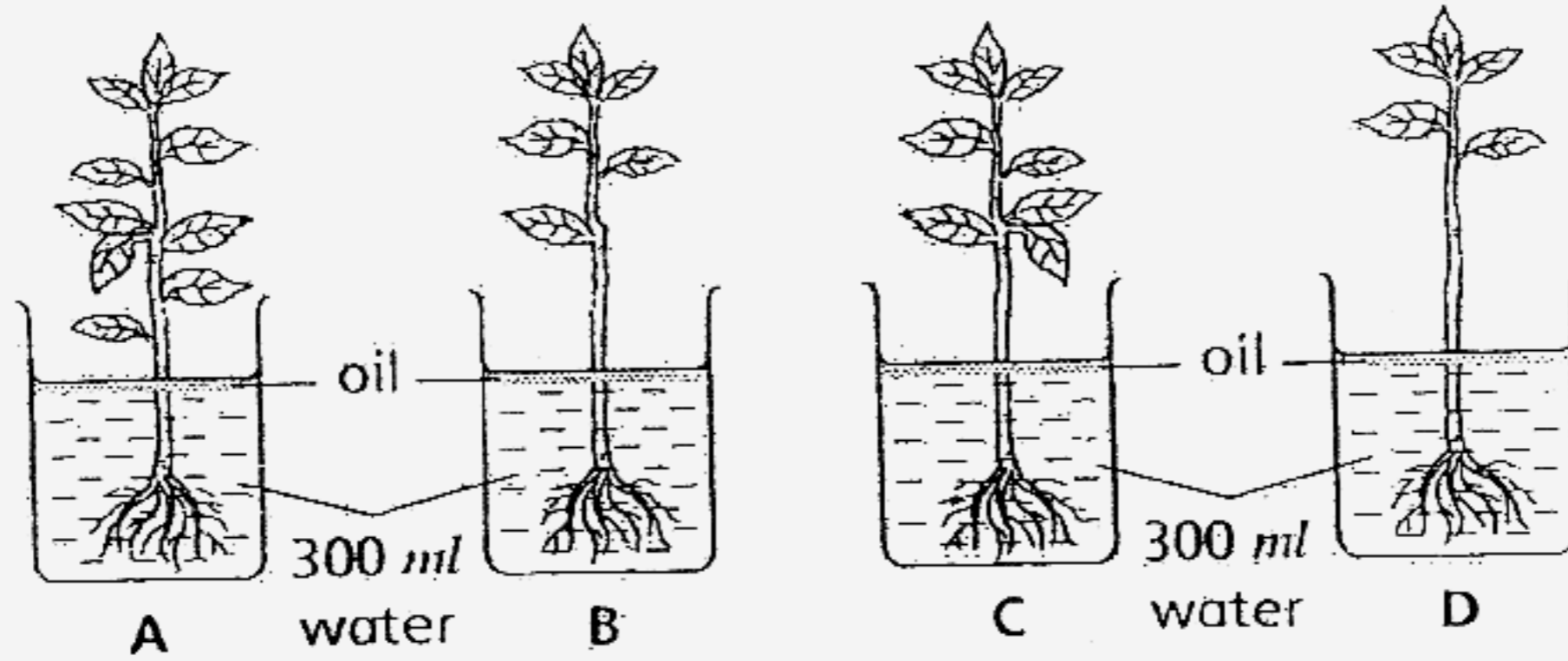

After two days, she observed the following results:

Plant	A	B	C	D
Number of leaves	10	6	9	5
Volume of water left (ml)	150	180	165	190

(i) What can you conclude from the results shown above?

[1]

(ii) What is the purpose of pouring a layer of oil on the surface of the water?

[1]

Score	2
-------	---

40. Read the following statements about energy. Write 'T' for the statements that are true or 'F' for the statements that are false in the brackets provided.

- (a) Energy is matter. ()
- (b) Energy exists in different forms. ()
- (c) Energy is needed by living things to grow. ()
- (d) The Sun is our main source of heat and light energy. ()

[2]

41. Classify the following objects according to the amount of light they allow to pass through them.

Clear plastic sheet	Cardboard	Mirror	Wooden ruler
Frosted glass	Aluminium foil	Tracing paper	Spectacle lens

Transparent	Translucent	Opaque

[4]

Score	6
-------	---

42. Study the diagram below.

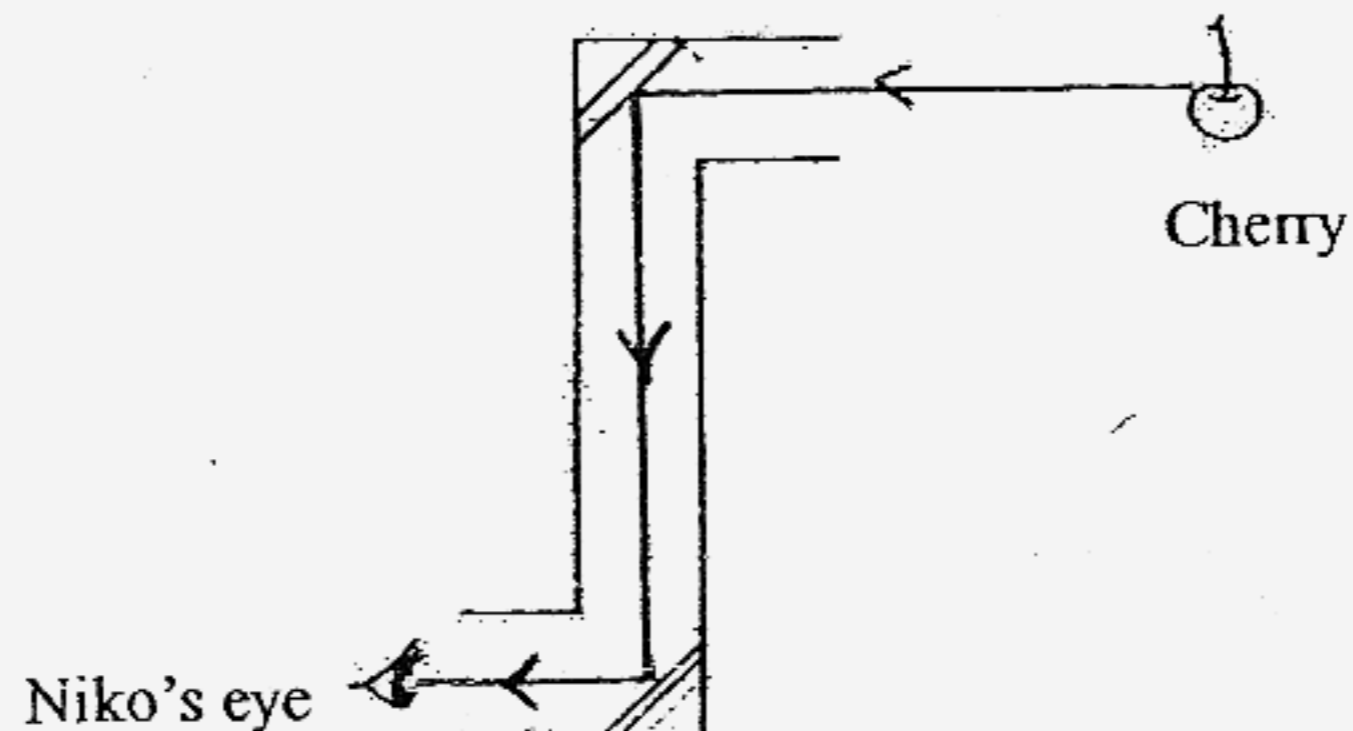

(a) In the above set-up, why was Niko not able to see the cherry?

[1]

(b) Niko was given **two** mirrors and was told that if she were to place the mirrors inside the set-up correctly, she would be able to see the cherry. Draw **lines** in the diagram given to represent where and how she should place these mirrors in order to see the cherry.

[1]

Score	2
-------	---

43. Galton left two identical containers with equal amounts of water at different temperatures in the room as shown below. The room temperature was 30°C.

Room temperature : 30°C

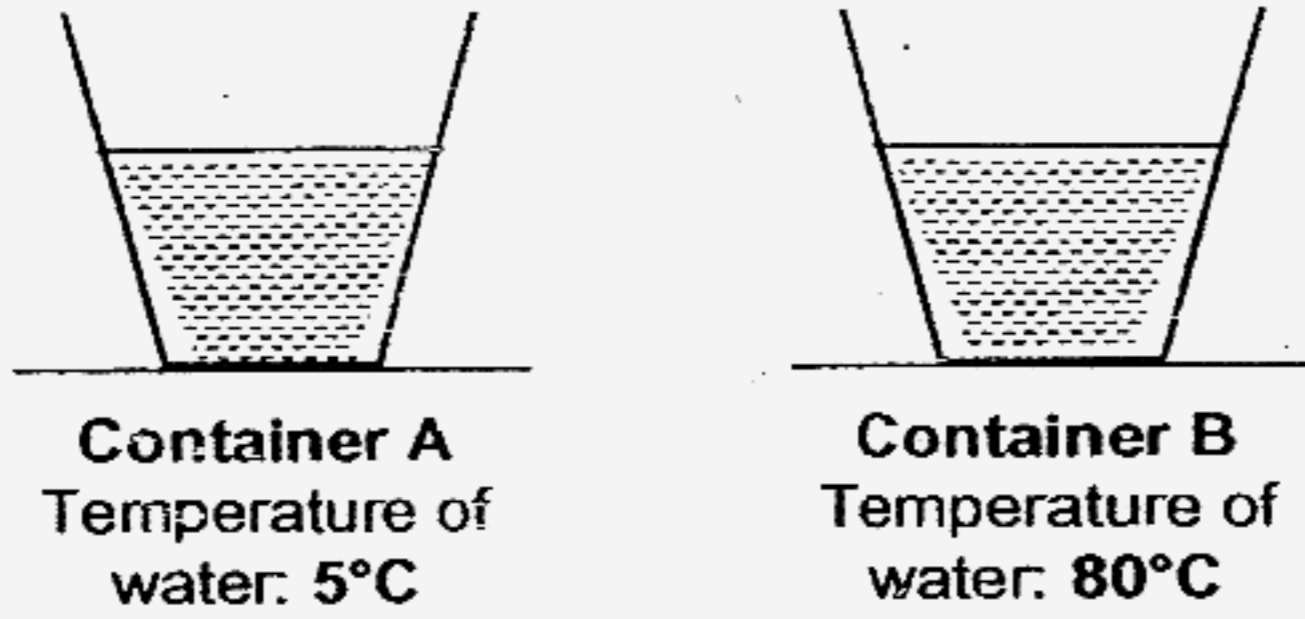

- (a) Put a tick (✓) in the correct box in the table below to indicate the changes in the water after 30 minutes.

[1]

	Gained Heat	Lost Heat	Increased in temperature	Decreased in temperature
Water in Container A				
Water in Container B				

- (b) What would the temperature of the water in container A be after 5 hours?

[1]

Score	2
-------	---

44. Chin Hao heated an empty flask over a burner as shown in the diagram below.

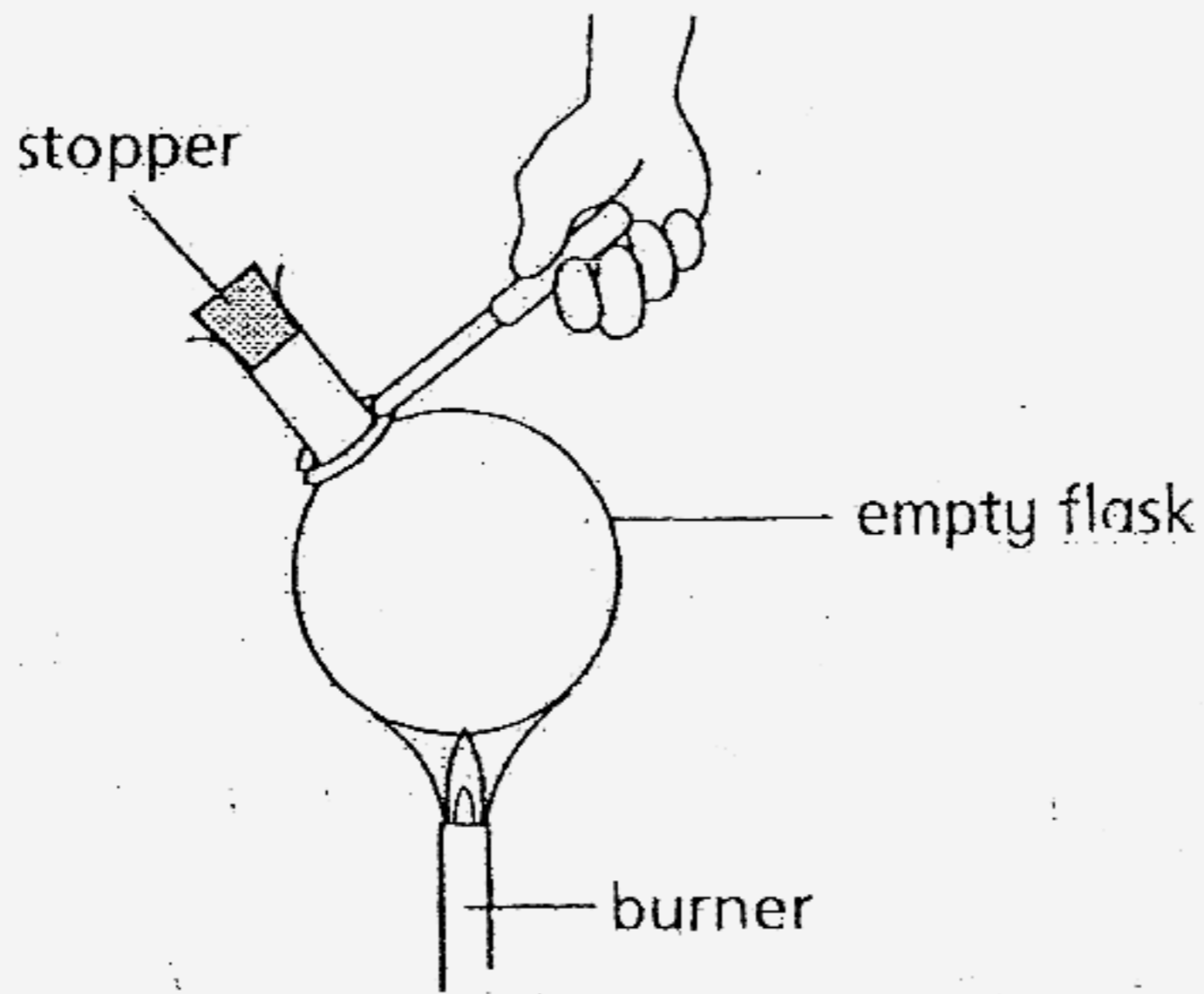

After some time, Chin Hao noticed that the stopper popped out.

Explain why the stopper popped out.

[2]

Score	2
-------	---

45. Classify the following objects according to their ability to conduct heat.

Rubber eraser	Styrofoam cup	Paper clip
Plastic chopstick	Aluminium tray	Gold chain

Bad Conductors of Heat	Good Conductors of Heat

[3]

Score	3
-------	---

46. Bala observed that a black ball was attracted to two magnets in the manner shown below.



- (a) What material was the black ball made of?

[1]

- (b) When the black ball is taken away, what will happen to the two magnets?

[1]

End of Examination
Setter: Mr P. Nair

Score	2
-------	---

NAN HUA PRIMARY SCHOOL - PRIMARY 4 SCIENCE 2007
 SEMESTRAL ASSESSMENT (2)

- 1. 3
- 2. 2
- 3. 4
- 4. 2
- 5. 1
- 6. 3
- 7. 1
- 8. 4
- 9. 1
- 10. 4
- 11. 4
- 12. 3
- 13. 4
- 14. 4
- 15. 3
- 16. 1
- 17. 3
- 18. 2
- 19. 4
- 20. 2
- 21. 3
- 22. 3
- 23. 3
- 24. 1
- 25. 3
- 26. 3
- 27. 4
- 28. 4
- 29. 3
- 30. 2

31) a)

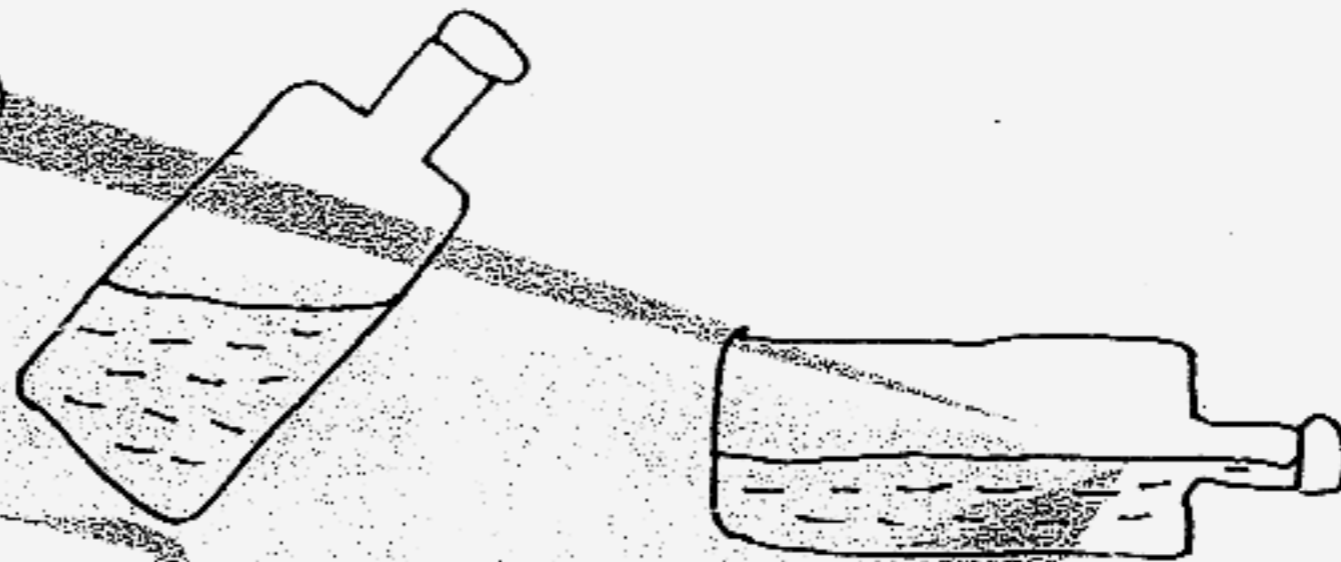

b) Liquid does not have a definite shape but has a definite volume.

32) a) Stoma

b) It takes in carbon dioxide and gives out oxygen for the plant.

33) a) Lungs.

b) The tissues in the body give carbon dioxide during respiration. As the blood passes through the tissues in the body, the blood exchanges oxygen for carbon dioxide.

34) a) 47°C, 3°C, 100°C, 66°C

b) Thermometer.

35) a) The plant will grow towards the window.

b) The plant can get more sunlight near the window.

36) Gullet, Stomach, Mouth, Small intestine

37) a) Liquid M is water.

b) The burner made the water evaporate into water vapour. The water vapour then condenses on the cool glass sheet to become water droplets.

38) a) To keep dirt from entering the body.

- b) i) Lungs ii) Windpipe
 iii) diaphragm iv) chest

39) a) It is to transport food made by the leaves to the rest of the plant.

b) i) The more leaves the plant has, the more water it needs.

ii) To prevent evaporation of water.

40) a) T b) T c) T d) T

41) Transparent: Clear plastic sheet, Spectacle lens

Translucent: Frosted glass, Tracing Paper

Opaque: Cardboard, Aluminium foil, Mirror

Wooden ruler

42) a) Light travels in a straight line.

b)

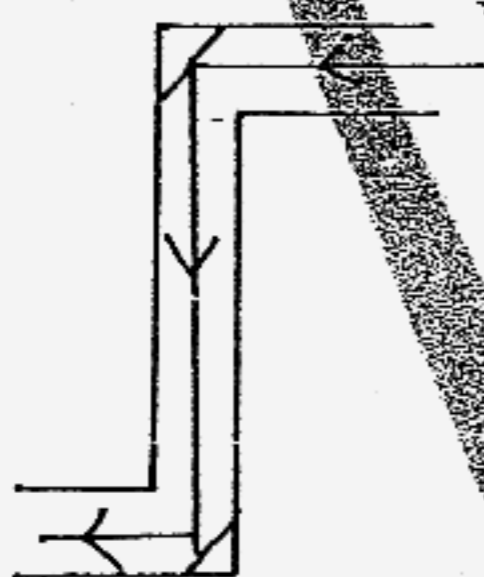

43) a) Water in A: Gained Heat. Increased in temperature

Water in B: Lost Heat. Decreased in temperature

b) It would be 30°C

44) The air in the flask gained heat from the burner and expanded, so the air forced the stopper out.

45) Bad conductors of Heat

Rubber eraser
Plastic chopstick
Styrofoam cup

Good conductors of Heat

Aluminium tray
Paper clip
Gold chain

46) a) It is made of iron.

b) They will attract each other.