

Pei Chun Public School
Semestral Assessment 1 – 2007
Mathematics
Primary 4

Booklet A

Name: _____ ()

Date: 7 May 2007

Class: Primary 4 _____

Time: 2 h

Maths Teacher: _____

Questions 1 to 12 carry 2 marks each. For each question, four options are given. One of them is the correct answer. Make your choice (1, 2, 3 or 4) and write its number in the brackets provided. (24 marks)

1. In 85 290, the digit 5 is in the _____ place.
(1) ones
(2) hundreds
(3) thousands
(4) ten thousands ()

2. Round off 32 649 to the nearest hundred.
(1) 32 600
(2) 32 650
(3) 33 000
(4) 33 700 ()

3. The best estimate for the height of a table is _____.
(1) 8 m
(2) 8 cm
(3) 80 cm
(4) 80 m () 175

4. The sum of the first three multiples of 7 is _____.

(1) 63

(2) 42

(3) 22

(4) 21

()

5. Which one of the following set of numbers are common factors of 16 and 36?

(1) 1 and 8

(2) 4 and 9

(3) 1, 2 and 4

(4) 8 and 12

()

6. Which one of the following angles is about 150° ?

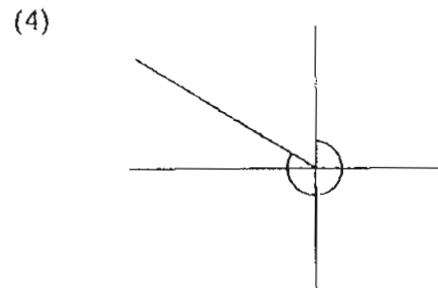
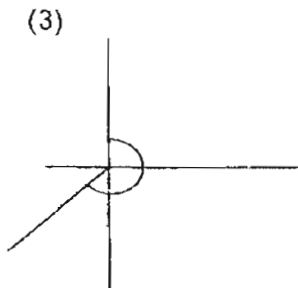
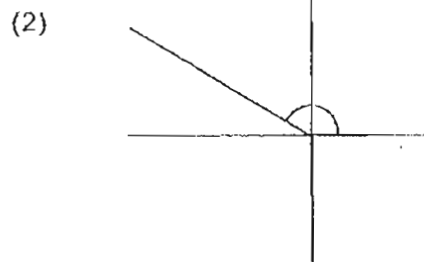
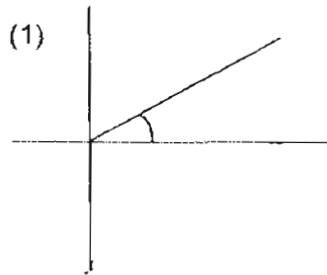

()

7. How many quarters are there in $5\frac{2}{8}$?
- (1) 21
 - (2) 22
 - (3) 40
 - (4) 42
- ()
8. Jazal bought nine packets of stickers. There were 116 stickers in each packet. How many stickers did she buy altogether?
- (1) 12
 - (2) 944
 - (3) 994
 - (4) 1044
- ()
9. Mr Choo saved \$370 a month. How much did he save at the end of 4 years?
- (1) \$1480
 - (2) \$4440
 - (3) \$14 800
 - (4) \$17 760
- ()
10. The total mass of Tim and Roger is 60 kg. The mass of Tim is 3 times that of Roger. What is the mass of Tim?
- (1) 15 kg
 - (2) 20 kg
 - (3) 40 kg
 - (4) 45 kg
- ()

11. $\frac{1}{3}$ of a number is 150. What is $\frac{1}{2}$ of the number?

- (1) 50
- (2) 75
- (3) 225
- (4) 450

()

12. Square A and Rectangle B ^{have} the same area.

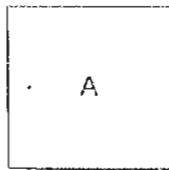

20 m

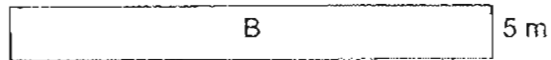

Find the perimeter of Rectangle B.

- (1) 16 m
- (2) 42 m
- (3) 80 m
- (4) 170 m

()

- 13. Refer to Booklet K.
- 14. Refer to Booklet K.
- 15. Refer to Booklet K.

End of Booklet A

Pei Chun Public School
Semestral Assessment 1 – 2007
Mathematics
Primary 4

Booklet B

Name : _____ ()

Marks :

Class : Primary 4 _____

Date : 7 May 2007

Time : 2 h

Maths Teacher : _____

Parent's Signature : _____

Booklet A	24
Booklet B	56
Booklet K	20
TOTAL	100

Questions 16 to 25 carry 1 mark each. Write your answers in the spaces provided.
For questions which require units, give your answers in the units stated.

(10 marks)

Do not write
in this space

16. Complete the following pattern:

31 290 , 30 290 , _____ , 28 290 , 27 290

Ans : _____

17. Write 14 212 in words.

SCORE

18. What is the value of the digit 6 in the number 64 397?

Do not write
in this space

Ans : _____

19. How many of the marked angles in this figure are greater than a right angle?

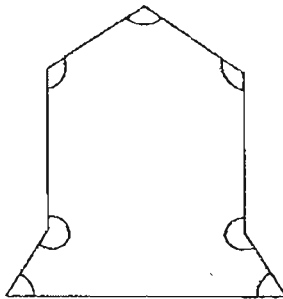

Ans : _____

20. Find the sum of 4528 and 9210.

Ans : _____

21. In this figure, AB is a straight line. Find $\angle x$.

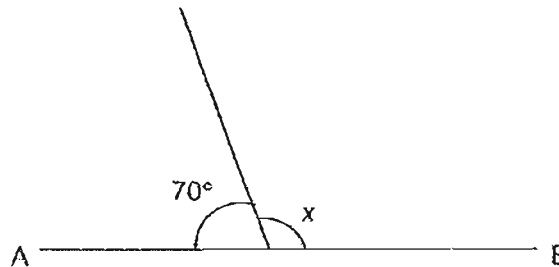

Ans : _____

SCORE

180

22. A square cardboard has an area of 144 cm^2 . Find its perimeter.

Do not write
in this space

Ans : _____ cm

23. Ai Li started her tennis practice at 11.40 am. She finished her practice 2 h 25 min later. What time did she finish her practice?

Ans : _____ pm

24.

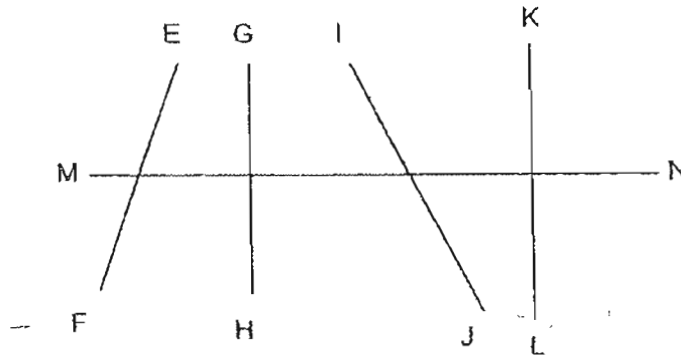

Name the line that is parallel to KL.

Ans : _____

25. $3 - \frac{1}{4} - \frac{1}{8} =$ _____

Ans : _____

181
SCORE

Questions 26 to 32 carry 2 marks each. Show your working clearly in the space below each question and write your answers in the spaces provided. For questions which require units, give your answers in the units stated (14 marks)

Do not write in this space

26. Write down the first three common multiples of 3 and 4.

Ans : _____

27. Karen bought more than 50 but less than 90 pieces of chocolate. She could either pack them equally into groups of 5 or 8. How many pieces of chocolate did she buy?

Ans : _____

28. Arrange the following fractions in order, beginning with the greatest.

$$\frac{1}{6}, \frac{1}{5}, \frac{3}{8}, \frac{2}{9}$$

Ans : _____

SCORE

29. The capacity of a can is half the capacity of a bottle. The total capacity of the bottle and can is 2 l 25 ml. What is the capacity of the can?

Do not write in this space

Ans : _____ ml

30. The figure below is made up of a big square and 3 identical small squares. What is the area of the figure?

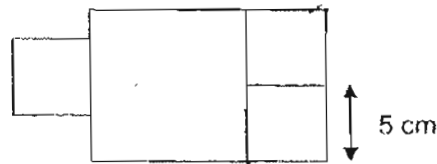

Ans : _____ cm²

31. The mass of an empty tin is 450 g. When it is full of biscuits, its mass is 1 kg 600 g. Find the mass of the tin when it is half full of biscuits.

Ans : _____ kg _____ g

183
SCORE

32. The area of a rectangle is 2 times that of a square. The area of the square is 64 cm^2 and the breadth of the rectangle is 8 cm. What is the length of the rectangle?

Do not write
in this space

Ans : _____ cm

-
33. Refer to Booklet K.
34. Refer to Booklet K.
35. Refer to Booklet K.

SCORE ¹⁸⁴

STAR ZEST HOME TUITION TEL 63845607

Questions 36 to 43 carry 4 marks each. Show your working clearly in the space below each question and write your answers in the spaces provided. (32 marks)

Do not write
in this space

-
36. Mrs Suma had \$45. She bought a fish weighing 2 kg and a whole chicken. The fish cost \$4.30 per kg and the chicken cost \$5.30. How much money had she left?

Ans : _____

SCORE 8

37. The figure below is made up of a square and 2 rectangles. The perimeter of the square is 16 cm. Find the area of the figure

Do not write
in this space

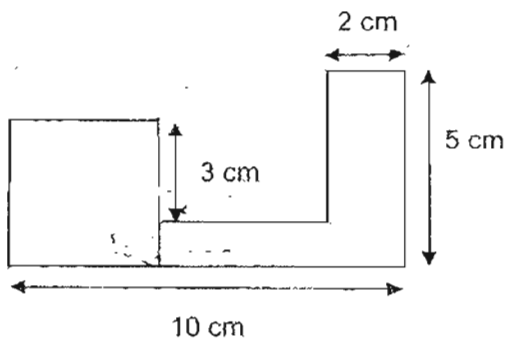

Ans : _____

SCORE

38. Yi Juan bought 50 boxes of pens. There were 125 pens in each box. She sold 1780 of the pens and repacked the rest equally into 6 bags. How many pens were there in each bag?

Do not write
in this space.

Ans : _____

SCORE

187

39. Mr Sng sold 450 ducks at \$19 each in 2 days. He sold 38 more ducks on the first day than on the second day. How much did he collect on the second day?

Do not write
in this space

Ans : _____

SCORE

40. Fiona had 180 tarts. She gave $\frac{1}{5}$ of the tarts to her brother and some tarts to her cousin. She had 104 tarts left. What fraction of the tarts did she give to her cousin? Give your answer in its simplest form.

Do not write
in this space

Ans : _____

SCORE ¹⁸⁹

43. 2 mangoes cost as much as 5 apples. Chee Meng bought 3 mangoes and 5 apples for \$15
- (a) How much did a mango cost?
 - (b) How much did an apple cost?

Do not write
in this space

Ans : (a) _____

(b) _____

44. Refer to Booklet K.

45. Refer to Booklet K.

End of Booklet B

Set by : Ms Florence Tan SL
Vetted by: P4 Maths Committee Teachers

SCORE

190

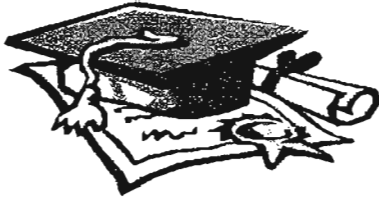

ANSWER SHEET

PEI CHUN PRIMARY SCHOOL - PRIMARY 4 MATHEMATICS 2007
SEMESTRAL ASSESSMENT (1)

1. 3
2. 1
3. 3
4. 2
5. 3
6. 2
7. 1
8. 4
9. 4
10. 2
11. 5
12. 1
13. 2
14. 0
15. 0
16. 29260
17. Fourteen thousand, two hundred and twelve
18. 0000
19. 5
20. 13738
21. 1402
22. 48cm
23. 2.05pm
24. GH
25. $2\frac{5}{8}$
26. 12, 24, 36
27. 80 pieces
28. $\frac{3}{8}, \frac{2}{9}, \frac{1}{5}, \frac{1}{6}$
29. 675ml
30. 175cm³

37) $16 \div 4 = 4$

$10 - 4 = 6$

$4 - 3 = 1$

$3 + 1 = 4$

$5 - 4 = 1$

$10 - 4 - 2 = 4$

$10 \times 5 = 50$

$4 \times 4 = 16$

$50 - 16 = 34$

$4 \times 4 = 16$

$34 - 16 = 18$

The area of the figure is 30cm^2

38) $125 \times 50 = 6250$

$6250 - 1780 = 4470$

$4470 \div 6 = 745$

There were 745 pens in each bag.

39) $450 - 38 = 412$

$412 \div 2 = 206$

$206 \times 19 = 3914$

He collected \$3914 on the second day.

40) $180 \div 5 = 36$

$180 - 39 = 141$

$144 - 104 = 40$

(Fiona gave $\frac{2}{9}$ of 180)

$= \frac{2}{9}$

She gave $\frac{2}{9}$ of the tarts to her cousin.

41) $260 \times 3 = 780$

$780 + 860 = 1640$

$= 16\text{L}40\text{ml}$

42) $10 \div 2 = 5$

$5 \times 11 = 55$

$5 \times 4 = 20$

$55 + 55 = 110$

$20 + 20 = 40$

$110 + 40 = 150$

The perimeter of the window is 4m 50cm

43) 3 mangoes \times 5 apple = 15

3 mangoes + 2 mangoes \rightarrow 15

1 mango \rightarrow 15 \div 3 = \$3

(2 mangoes \times 5 apple) \rightarrow 6

1 apple \rightarrow 6 \div 5 = \$1.20