



AI TONG SCHOOL

2007

CONTINUAL ASSESSMENT 2

PRIMARY 4

MATHEMATICS

DURATION : 1 h 45 min

DATE : 28 August 2007

INSTRUCTIONS

Do not open the booklet until you are told to do so.

Follow all instructions.

Answer all questions.

Name : _____ ()

Class : Primary 4 _____

Marks:

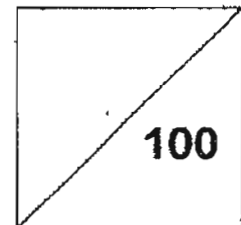

Parent's Signature : _____

Date : _____

Section A

Questions 1 to 10 carry 1 mark each. Questions 11 to 15 carry 2 marks each.

For each question, four options are given. One of them is the correct answer.

Make your choice (1, 2, 3 or 4). Shade the oval (1, 2, 3 or 4) on the Optical Answer Sheet with a 2B pencil. (20 marks)

1. $36\ 909 = 30\ 000 + \boxed{} + 900 + 9$

What is the missing number in the box?

- (1) 60
- (2) 600
- (3) 6000
- (4) 60 000

2. Mr Lim bought a car for \$89 605.
Round off this amount to the nearest \$1000.

- (1) \$89 000
- (2) \$89 600
- (3) \$89 700
- (4) \$90 000

3. Which one of the following is the best estimate of 389×48 ?

- (1) 12 000
- (2) 15 000
- (3) 16 000
- (4) 20 000

4. The product of two numbers is 3684. If one of the numbers is 6, the other number is _____.

- (1) 614
- (2) 3678
- (3) 3690
- (4) 22 104

5. Which one of the following fractions is smaller than $\frac{1}{2}$?
- (1) $\frac{3}{5}$
 - (2) $\frac{7}{8}$
 - (3) $\frac{5}{9}$
 - (4) $\frac{5}{11}$
6. The cost of a dress, when rounded off to the nearest dollar, is \$53. Which one of the following could be the actual cost of the dress?
- (1) \$52.10
 - (2) \$52.50
 - (3) \$53.50
 - (4) \$53.95
7. 6 ones, 9 tenths and 4 thousandths is _____.
- (1) 0.694
 - (2) 6.094
 - (3) 6.904
 - (4) 6.94
8. Which one of the following numbers is the smallest?
- (1) 4.10
 - (2) 4.80
 - (3) 4.01
 - (4) 4.81

9. 0.05 expressed as a fraction in its simplest form is _____.

(1) $\frac{1}{2000}$

(2) $\frac{1}{200}$

(3) $\frac{1}{20}$

(4) $\frac{1}{2}$

10. Find the first common multiple of 4 and 6.

(1) 2

(2) 10

(3) 12

(4) 24

11. The sum of two numbers is 824. The difference between the two numbers is 28. Find the larger number.

(1) 398

(2) 426

(3) 796

(4) 852

12. There are 12 pears and 20 oranges in a basket. What fraction of the fruits are oranges?

(1) $\frac{1}{5}$

(2) $\frac{3}{5}$

(3) $\frac{3}{8}$

(4) $\frac{5}{8}$

13. $7 + \frac{9}{50}$ is the same as _____.

- (1) 7.09
- (2) 7.18
- (3) 7.5
- (4) 7.9

14. Lynn and Michael sat for a Mathematics Test. Lynn scored $\frac{4}{5}$ of what Michael scored. Lynn scored 60 marks. What was Michael's score?

- (1) 12
- (2) 48
- (3) 60
- (4) 75

15. The figure is made up of 5 identical squares each of side 3 cm. What is the perimeter of the figure?

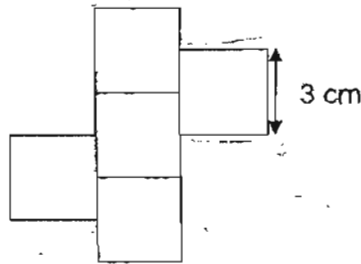

- (1) 12 cm
- (2) 16 cm
- (3) 36 cm
- (4) 48 cm

STAR ZEST HOME TUITION TEL 63845607

Section B

Questions 16 to 35 carry 2 marks each. Write your answers in the spaces provided. For questions which require units, give your answers in the units stated.

(40 marks)

16. Write forty-eight thousand, five hundred and three in figures.

Ans: _____

17. Round off the product of 243 and 56 to the nearest ten.

Ans: _____

18. Find the value of $6032 \div 8$.

Ans : _____

19. The number of stickers in Amy's collection doubled every month.
There were 288 stickers in her collection in July.
How many stickers were there in **April**?

Month	April	May	June	July	August
Stickers	?	72	144	288	576

Ans : _____

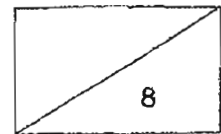

20. Look at the number pattern. What is the missing number?

24 000, 24 500, 24 900, _____, 25 800, 26 300

Ans : _____

21. Find the missing factor.

$$2 \times 250 = 10 \times \square$$

Ans : _____

22. Write down the common factor of 9 and 21 that is greater than 1.

Ans: _____

23. Trees are planted 5 m apart along a straight road.

If the road is 50 m long, find the total number of trees along this stretch of road.

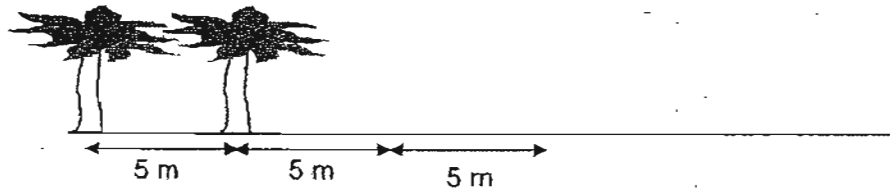

Ans: _____

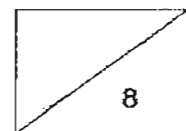

24. Mandy bought a pair of shoes and a shirt. She paid \$108 for them. If the shoes cost three times as much as the shirt, find the cost of the shoes.

Ans :\$ _____

25. Find the value of $4 - \frac{5}{12}$.

Ans: _____

26. Arrange these fractions from the smallest to the largest:

$$2, \quad \frac{7}{5}, \quad 1\frac{7}{10}$$

Ans : _____

27. A rectangular tank contains 18 litres of water when it is $\frac{3}{8}$ full.
How much water is in the tank if it is half full?

Ans : _____ l

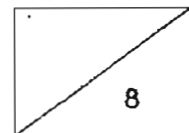

28. Which letter in the word below has both parallel and perpendicular lines?

L A M E

Ans : _____

29.

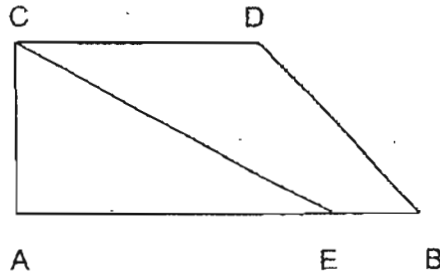

Name the pair of parallel lines in the figure above.

Ans : _____

30. Jack is standing at X and he is facing east. He makes a $\frac{3}{4}$ turn in an anti-clockwise direction. He will be facing _____.

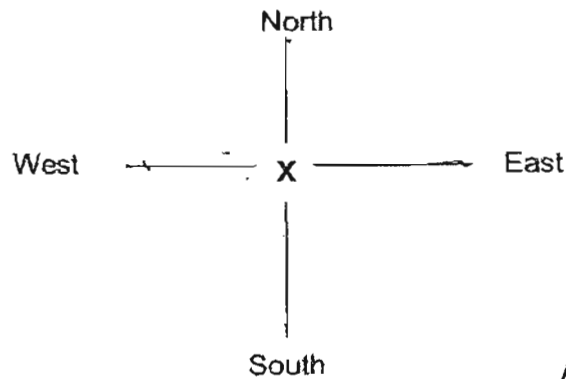

Ans : _____

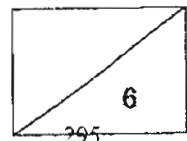

31. In the figure below, ABC is a straight line. Find $\angle x$.

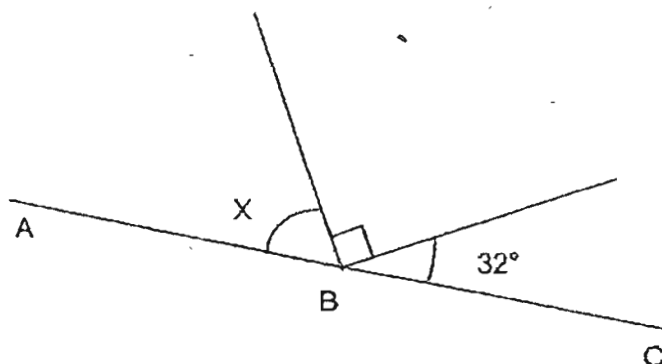

Ans: _____

32. The figure below is not drawn to scale.
Find the **area** of the figure.

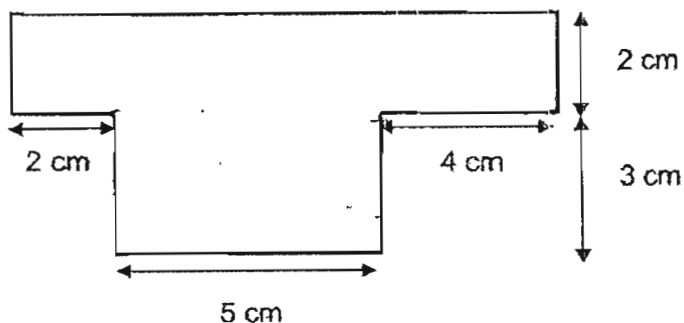

Ans: _____ cm^2

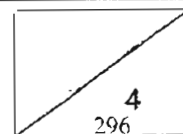

33. The area of a square is 81 cm^2 . Find its perimeter.

Ans : _____ cm

34. Find the value of $2.8 + 9.67$.

Ans : _____

35. Peter saved \$38.90. This was \$7.85 more than what his sister saved. How much money did Peter's sister save?

Ans : \$ _____

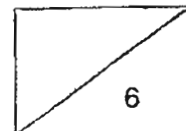

Section C

Questions 36 to 45 carry 4 marks each. Show your working clearly in the space provided below each question and write your answers in the spaces provided.

(40 marks)

36. Derrick and Ted had some marbles. After giving 100 marbles to Ted, Derrick found that they had the same number of marbles. If Ted had 80 marbles at first, how many marbles did Derrick have at first?

Ans: _____ [4]

37. 3 sisters and 2 brothers paid \$3450 to buy a television set. Each of the sisters contributed \$550. The rest of the cost was shared equally between the 2 brothers. How much did each of the brothers pay?

Ans: _____ [4]

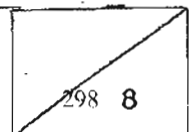

38. 0.5 kg of salmon cost \$15. Joey bought 1.5 kg of salmon. If she gave the cashier \$100, how much change would she get?

Ans: _____ [4]

39. A basket and 8 tins of mushrooms weigh 5.05 kg.
Each tin of mushrooms weighs 0.43 kg.
Find the mass of the basket when it is empty.

Ans: _____ [4]

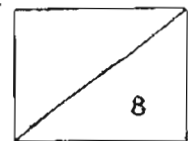

299

40. Annie and Janet had \$280 altogether at first. Janet received another \$40 from her mother. She now had three times as much money as Annie. How much money had Janet now?

Ans: _____ [4]

-
41. A bag contains some green and blue marbles. $\frac{3}{5}$ of the marbles are green. There are 40 more green marbles than blue marbles. How many marbles are there?

Ans: _____ [4]

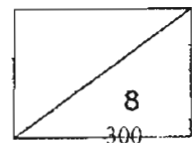

42. Mr Ling bought some stamps to be shared among his 3 children.
 He gave $\frac{1}{3}$ of the stamps to Ron, $\frac{5}{12}$ to Tom and the rest to Dan.
 If Dan received 24 stamps, how many stamps did Mr Ling buy at first?

Ans: _____ [4]

43. The figure below is not drawn to scale. ABCD is a square and EAF is a straight line. $\angle DAE = 35^\circ$, find $\angle x$.

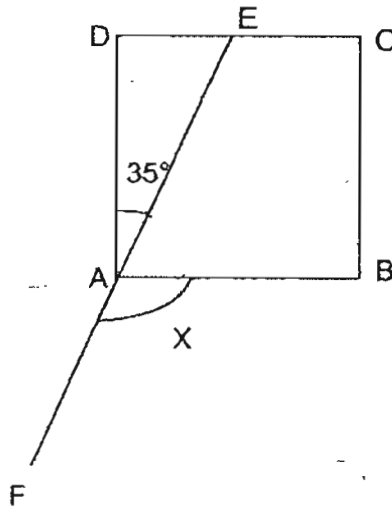

Ans : _____ [4]

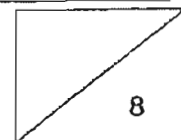

44. Jonathan bought 3 mangoes, 2 pears and 4 oranges for \$10.
Tom bought 1 pear and 2 oranges for \$3.20.
Find the cost of 1 mango.

Ans: _____ [4]

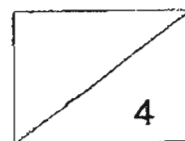

45. The figure shows a rectangular field which measures 35 m by 20 m.
There is a rectangular flower bed at the centre of the field.
Find the area of the flower bed.

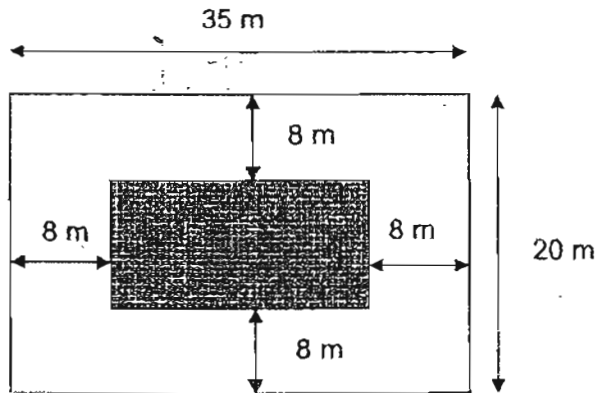

Ans: _____ [4]

End-of-paper
Please check your work carefully

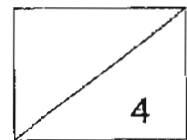

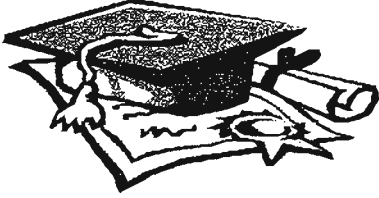

ANSWER SHEET

AI TONG PRIMARY SCHOOL - PRIMARY 4 MATHEMATICS 2007
CONTINUAL ASSESSMENT (2)

1. 3
2. 4
3. 4
4. 1
5. 4
6. 2
7. 3
8. 3
Derrick have 280 marbles at first
9. 3
10. 3
37) $\$550 \times 3 = \1650
11. 2
 $\$3450 - \$1650 = \$1800$
12. 4
 $\$1800 \div 2 = \900
13. 2
Each of the brother paid \$900
14. 4
15. 3
38) $0.5\text{kg} \div 1.5\text{kg} = 3$
16. 48503
 $\$15 \times 3 = \45
17. 12610
 $\$100 - \$45 = \$55$
18. 754
She would get \$55 change
19. 36 stickers
20. 3400
39) $0.43 \times 8 = 3.44\text{kg}$
21. 50
 $5.05 - 3.44 = 1.61\text{kg}$
22. 3
The mass of the basket is
23. 11 trees
1.60kg.
24. \$81
25. $3\frac{7}{12}$
40) Janet \$320
26. $\frac{7}{5}, 1\frac{7}{10}, 2$
Annie
27. 24
 $\$280 + \$40 = \$320$
28. E
 $\$320 \div 4 = \80
29. CD//AB
 $\$80 \times 3 = \240
30. South
Janet have \$240 now.

41) 200

42) $24 \div 3 = 8$

1 unit = 8

$12 \times 8 = 96$ stamps

Mr Ling bought 96 stamps at first.

43) $\angle EAF = 180^\circ$

$90^\circ - 35^\circ = 55^\circ$

$180^\circ - 55^\circ = 125^\circ$

$\angle x$ is 125°

44) $\$1.20 \times 2 = \6.40

$10 - \$6.40 = \3.60

$\$3.60 \div 3 = \1.20

The cost of 1 mango is \$1.20

45) $20 - 8 - 8 = 4$

$3548 - 8 = 19$

$19 \times 4 = 76$

The area of flower bed is $76m^2$

