

**Primary Three  
Mathematics  
Semestral Assessment Two**

**Section A: Each question carries 2 marks and is followed by four possible answers. Mark your choice [1, 2, 3, 4] in the given box. (20 x 2 marks)**

1. The value of 3 thousands, 3 tens and 3 ones is \_\_\_\_\_.

- (1) 333
- (2) 3033
- (3) 3303
- (4) 3330

2. The diagram shows \_\_\_\_\_.

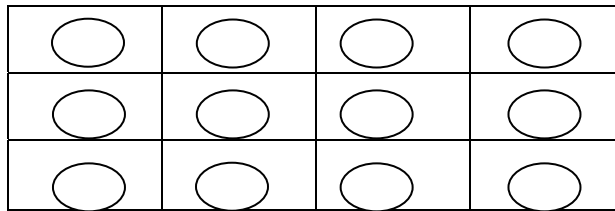

- (1)  $4 + 3$
- (2)  $4 \times 3$
- (3)  $4 \times 4 \times 4$
- (4)  $3 \times 3 \times 3 \times 3$

3. What is the product of 564 and 4?

- (1) 2265
- (2) 2256
- (3) 2184
- (4) 141

4.  $4 \text{ h } 5 \text{ min} - 2 \text{ h } 35 \text{ min} =$  \_\_\_\_\_

- (1) 1 h 30 min
- (2) 2 h 30 min
- (3) 2 h 40 min
- (4) 6 h 40 min

5. 295 min = \_\_\_\_ h \_\_\_\_ min

- (1) 2 h 55 min
- (2) 2 h 95 min
- (3) 4 h 55 min
- (4) 4 h 95 min

6. How many right angles are there in the figure?

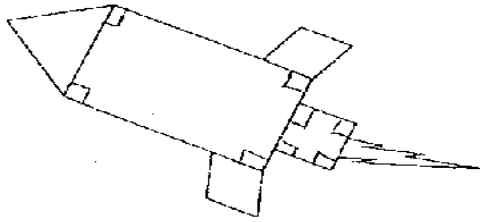

- (1) 22
- (2) 16
- (3) 12
- (4) 8

7. 806 is \_\_\_\_\_ tens more than 606.

- (1) 20
- (2) 2
- (3) 200
- (4) 2000

8. The beaker is filled with 3 cups of water and 1 teapot of water. Find the capacity of the teapot.

teapot.

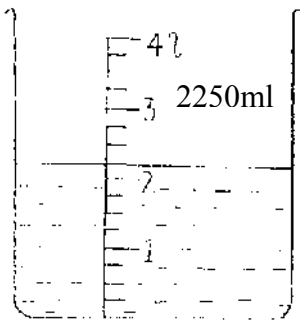

200 ml



200 ml



200 ml

- (1) 600 mL
- (2) 1 L 600 mL
- (3) 1 L 650 mL
- (4) 2 L 850 mL

9. A large pizza was cut into 8 pieces. Mr. Teo ate 4 pieces, Mrs Teo ate 2 pieces and their son ate the rest. What is the fraction of the pizza did their son eat?

- (1)  $\frac{3}{4}$
- (2)  $\frac{1}{2}$
- (3)  $\frac{1}{4}$
- (4)  $\frac{1}{8}$

10. SQ 007 departs from Singapore at 15 minutes to 6a.m. The plane lands in Thailand at 25 minutes past 8 in the morning. How long is the flight?

- (1) 2 h 40 min
- (2) 2 h 10 min
- (3) 1 h 50 min
- (4) 1 h 20 min

11. Find the missing number.

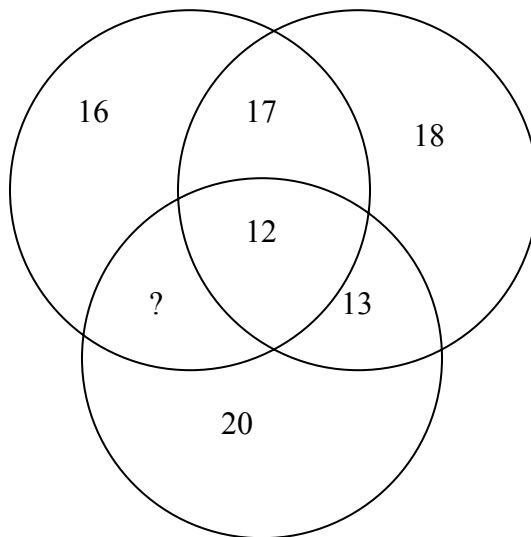

- (1) 9
- (2) 11
- (3) 15
- (4) 19

12. The square is equal to \_\_\_\_\_ .

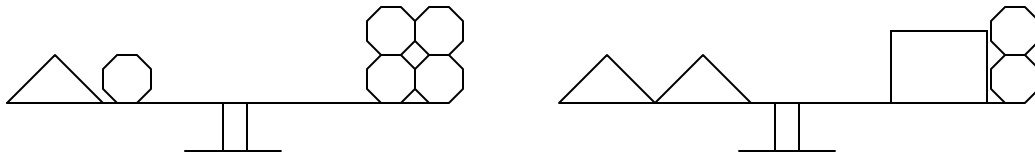

- (1) 1
- (2) 2
- (3) 3
- (4) 4

13. Find the shaded area.

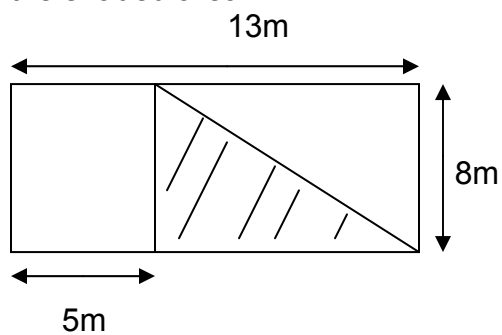

- (1)  $104 \text{ m}^2$
- (2)  $64 \text{ m}^2$
- (3)  $40 \text{ m}^2$
- (4)  $32 \text{ m}^2$

14. Subtract 13 hundreds from 5541. The answer is \_\_\_\_\_.

- (1) 5528
- (2) 5411
- (3) 4241
- (4) 4214

15. \_\_\_\_\_  $\times 7 = 266$

- (1) 1928
- (2) 1862
- (3) 38
- (4) 32

16. The distance round a park is 750m. What distance will Raj cover if he runs round the park 5 times?

- (1) 1km 500m
- (2) 3km 75 m
- (3) 3km 750m
- (4) 5km 750m

17. Suzie uses 184 cm of ribbon to make 4 bows and 36cm of ribbon to tie a present. How much ribbon would she need if she wants to make 2 bows and tie a present?

- (1) 220cm
- (2) 148cm
- (3) 128cm
- (4) 82 cm

18. Which one of the following is the same as 3500 cents?

- (1) \$3.50
- (2) \$35.00
- (3) \$350.00
- (4) \$3500.00

19. What fraction of the whole is not shaded?



- (1) 2/12
- (2) 4/12
- (3) 6/12
- (4) 8/12

20. Which one of the following is not equivalent to 6/12?

- (1) 1/2
- (2) 2/4
- (3) 3/6
- (4) 6/9

**Section B (40 marks): Work out each sum and write the answer in the box provided.**

21. What fraction when added to  $\frac{3}{9}$  will make 1 whole?  
Give your answer in the simplest form.

22. In the figure below, how many angles are greater than a right angle?

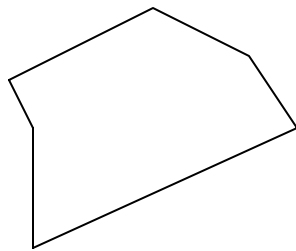

23. This figure is not drawn to scale. It is made up of 1-cm squares. What is the perimeter of the figure?

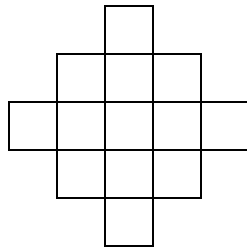

24. \_\_\_\_\_ is 250 more than 350

25.  $6\ 000 \div 5 =$  \_\_\_\_\_ hundreds

The graph shows the number of marbles each child has. Use it to answer questions 26 and 27.

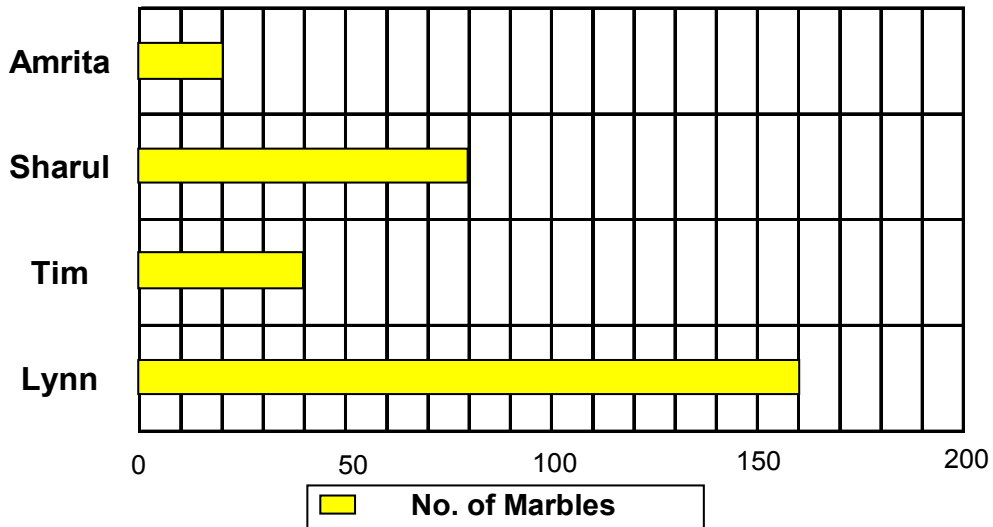

26. \_\_\_\_\_ has twice as many marbles as Tim.

27. How many marbles must Lynn give to Amrita so that they have the same number of marbles?

The diagram below shows the time taken to travel from one MRT station to another. Use it to answer questions 28 and 29.

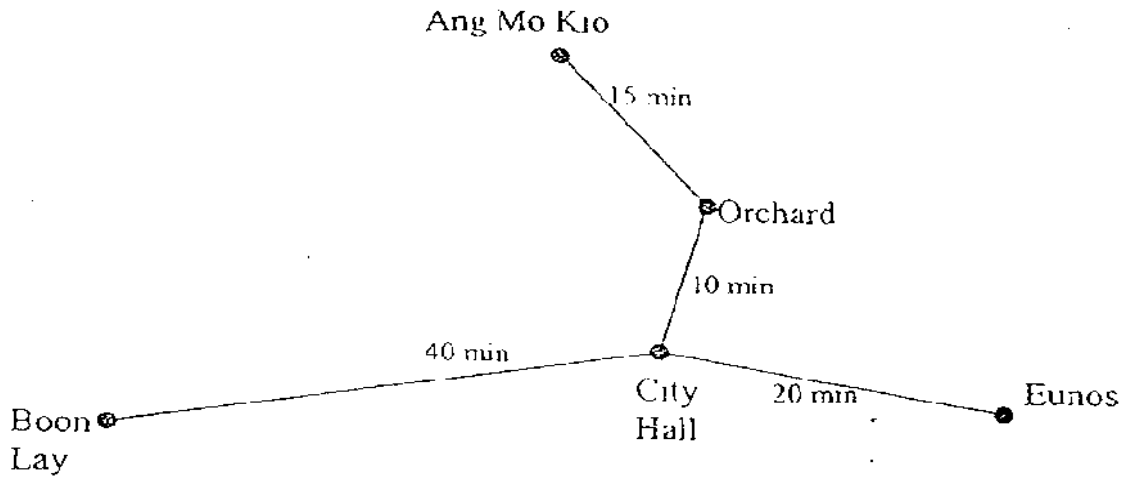

28. How long does the MRT train take to travel from Ang Mo Kio station to City Hall Station?

 min

29. John traveled from Boon Lay to Ang Mo Kio. Mary traveled from Eunos to Ang Mo Kio. How much longer did John take?

 min

30. A bucket is marked into 6 equal levels. It can hold 24 cups or 18 bowls of water. After pouring 8 cups and 3 bowls of water into the empty bucket, that water level should reach \_\_\_\_\_.

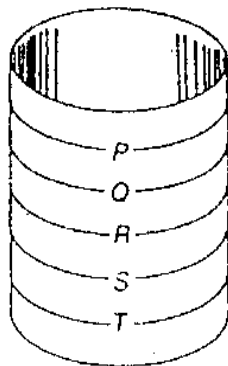



31. Find the missing fraction in the number pattern. Give your answer in the simplest form.

$1/3$ , \_\_\_\_\_,  $8/12$ ,  $5/6$

- 32.

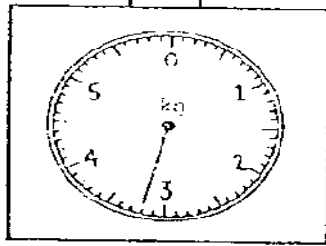
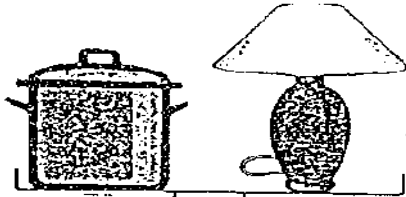

What is the weight of the lamp?

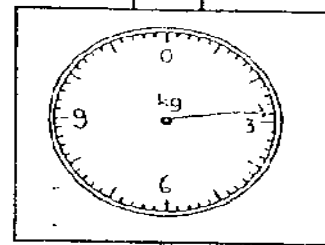

33. Find the total value of 5 one-dollar notes, 6 twenty-cent coins, 3 fifty-cent coins and 7 five-cent coins.

\$

34. The length of a rectangle is 18cm. The length is twice the breadth. Find the area of the rectangle.

35. In the number '8 914', which digit is in the hundreds place?

36. Form the biggest 4-digit even number using 1 , 4 , 0 , 2

37. The difference between 9 675 and 206 is \_\_\_\_\_.

38. What is the remainder when 653 is divided by 7?

39. Write 5 088 ml in litres and milliliters.

40. What is the simplest form of  $\frac{18}{24}$ ?

**Section C (20 marks): Show all the workings for the problem sums in the space provided. Marks will be awarded for the correct workings, statements and answers.**

41. The weight of Getha's bag is 3 kg 790 g. Peter's bag is 1 kg 810 g heavier. What is the total weight of their bags? **Give your answer in kilograms and grams.**
42. Joshua spent a total of \$120 on a pair of soccer boots and a soccer ball. The pair of soccer boot \$48 more than the soccer ball. How much does the pair of soccer boots cost?

43. The perimeter of a square is 12m. The perimeter of a rectangle is twice that of the square. The length of the rectangle is 8m. What is its breadth?

44. Ann bought nine 25-cent stamps. She paid the cashier \$3. How much change did she get?

45. Joy started drawing at 1.25pm. He took 45 minutes to draw and 1 h 10 min to finish painting his drawing. At what time did he finish painting?

End of paper