

SIA 2



RAFFLES GIRLS' PRIMARY SCHOOL

SEMESTRAL ASSESSMENT (2)
2004

Name: _____ Class: P3 _____ Index No: _____

Nov 2004

MATHEMATICS

Att: 1h 45min

Your Score		
Out of 100 marks		
	Class	Level
Highest score		
Average score		
Parent's Signature:		

SECTION A (20 X 2 marks)

Questions 1 to 20 carry 2 marks each. Choose the correct answer and write its option number (1,2,3 or 4) in the brackets provided.

1. Six thousand and thirty-nine is the same as _____.

- (1) 6 309
- (2) 6 039
- (3) 6 093
- (4) 6 390

()

2. What is the sum of 400 and 15 ?

- (1) 295
- (2) 385
- (3) 415
- (4) 550

()

3. What is the next odd number after 7 ?

- (1) 8
- (2) 9
- (3) 10
- (4) 11

()

4. 257 cm is the same as _____.

- (1) 2 m 57 cm
- (2) 2 m 570 cm
- (3) 25 m 7 cm
- (4) 25 m 70 cm

()

5. What is 3 kg 70 g in grams?

- (1) 3 007 g
- (2) 3 070 g
- (3) 3 700 g
- (4) 7 300 g

()

6. How many 20-cent coins are there in five dollars?

- (1) 5
- (2) 10
- (3) 25
- (4) 50

()

7. $\frac{8}{12}$ is also equal to _____.

- (1) $\frac{2}{3}$
- (2) $\frac{5}{6}$
- (3) $\frac{1}{4}$
- (4) $\frac{4}{12}$

()

8. What is the time shown on the clock below?

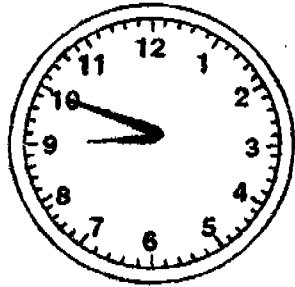

- (1) 10 minutes to 9
- (2) 10 minutes past 9
- (3) 50 minutes to 8
- (4) 50 minutes past 9

()

9. If 4 times a number is 32, what is the number ?

- (1) 7
- (2) 8
- (3) 36
- (4) 128

()

10. Find the difference between the first and the fourth number given below.

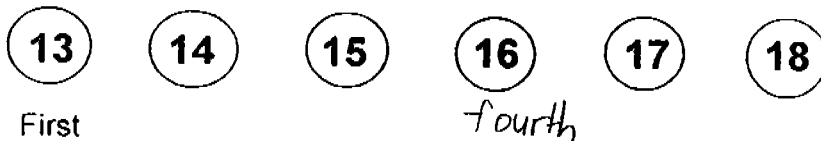

- (1) 29
- (2) 33
- (3) 3
- (4) 4

()

11. Which number gives a remainder of 1 when divided by 3?

- (1) 20
- (2) 21
- (3) 22
- (4) 23

()

12. What is the volume of the water in the beaker?

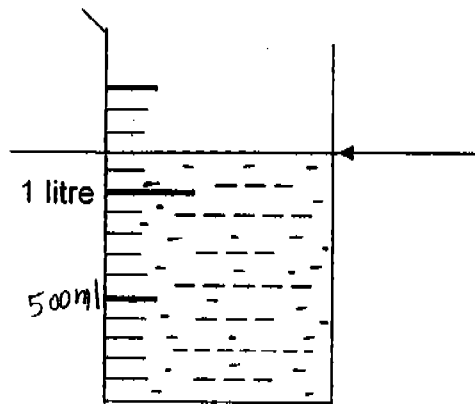

- (1) 1 l 200 ml
- (2) 1 l 400 ml
- (3) 1 l 450 ml
- (4) 1 l 500 ml

()

13. I have 

My brother has  fewer than what I have.

If  stands for 2 picture cards, how many picture cards does my brother have ?

- (1) 12
- (2) 8
- (3) 6
- (4) 4

()

14. Which fraction in the box has the biggest numerator?

$\frac{1}{8}$	$\frac{2}{3}$	$\frac{4}{5}$	$\frac{3}{4}$
---------------	---------------	---------------	---------------

- (1) $\frac{1}{8}$
- (2) $\frac{2}{3}$
- (3) $\frac{4}{5}$
- (4) $\frac{3}{4}$

()

15. 3 years 10 months = _____ months.

(1) 36

(2) 37

(3) 40

(4) 46

()

16. The figure below is made up of 1-cm squares. Find the perimeter of the figure.

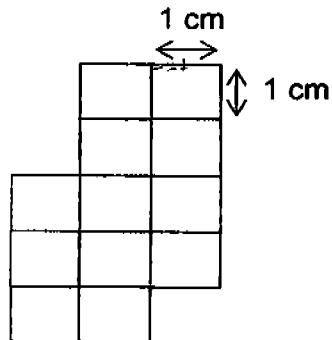

(1) 12 cm

(2) 14 cm

(3) 16 cm

(4) 32 cm

()

17. Rectangle B has an area of 12 cm^2 .
What is the difference in area between Rectangle A and Rectangle B?

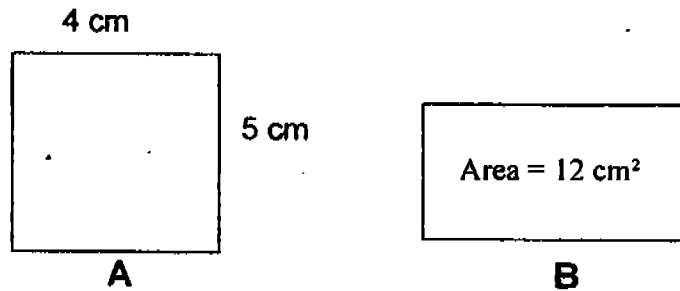

- () 8 cm^2
 () 2 cm^2
 () 12 cm^2
 () 20 cm^2 ()

18. Tom ran 2 km 300 m in a race.
Ali ran 1 km 900 m. How much farther did Tom run than Ali?

- (1) 400 m
 (2) 600 m
 (3) 1 km 600 m
 (4) 4 km 200 m ()

- 19 Find the difference between the heaviest and the lightest weights given below.

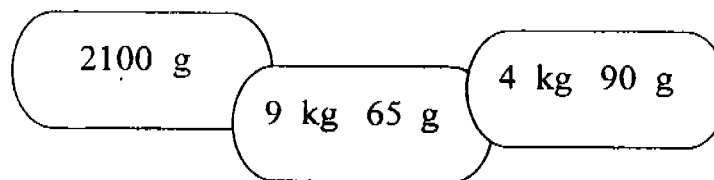

- (1) 1 kg 990 g
 (2) 4 kg 75 g
 (3) 4 kg 975 g
 (4) 6 kg 965 g ()

20. Joan bought 5 packets of milk.
How much did she pay for them ?



\$0.90

- () \$ 2.70
- () \$ 3.60
- () \$ 4.50
- () \$ 5.40

()

SECTION B: (20 X 2 marks)

Read each sum carefully. Write the correct answer for each sum in the box provided.

21. In the number 4926, the digit '2' is in the _____ place.

22. Subtract 50 from 715. The answer is

23. Multiply 302 by 8. What is the answer?



24. $5004 \text{ m} =$ km m

25. \$ 9.50 is also equal to cents

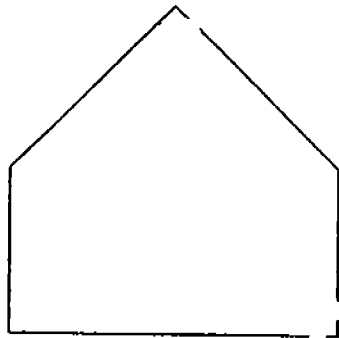
26. How many right angles are there in the figure below ?



right angles

27. If $14 + 8 =$ 
What is the product of  and 5 ?

28. How many 100g are there in 4 kg ?
The answer is _____.

29. A tank has a capacity of 2 litres. Bala poured 120 ml of water into the tank. How many millimetres more water are needed to fill up the tank completely? *millilitres*

 ml

30. The graph below shows the number of stickers three boys have.

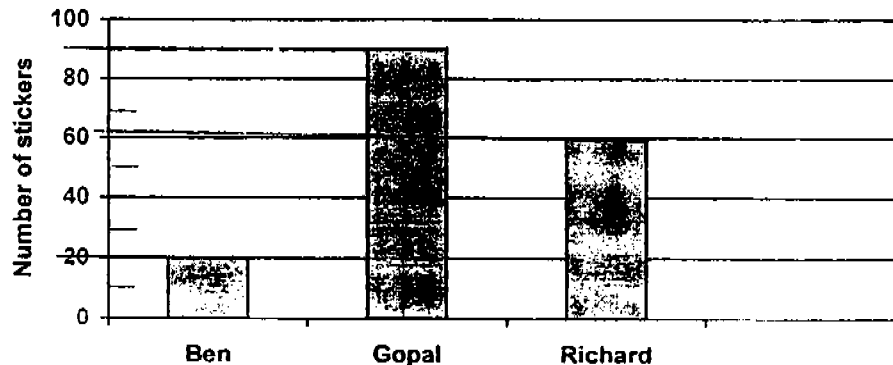

How many stickers must Richard give Ben so that both of them will have the same number of stickers ?

 stickers

31. A movie started at 3.45 p.m. and ended at 6.00 p.m. How long did the movie last ?

	h		min
--	---	--	-----

32. What is twice the length of time of 90 minutes?

	h		min
--	---	--	-----

33. There are 6 angles inside the figure given below. How many of the angles are **greater** than a right angle?

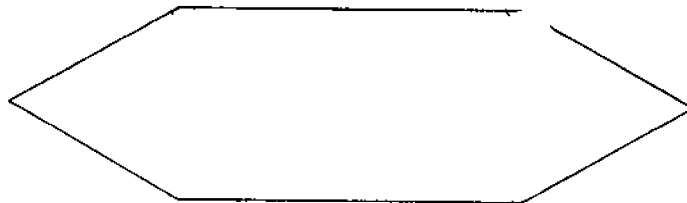

	angles
--	--------

34. All the square units in the two figures are of the same size.
Area A is bigger than Area B by _____ square units.

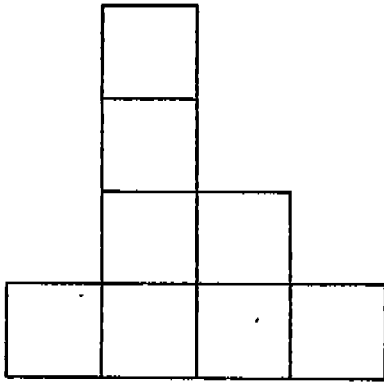

Fig. A

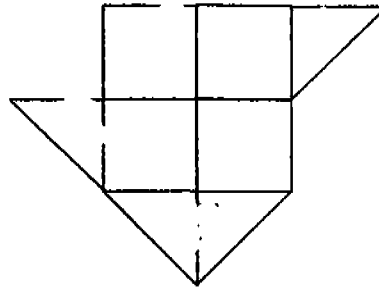

Fig. B

square units

35. Study the number pattern. What is the next number in the box ?

2400 , 2410 , 2430 , 2440 ,

36. Fill in the missing numbers in the two boxes to make the picture complete.

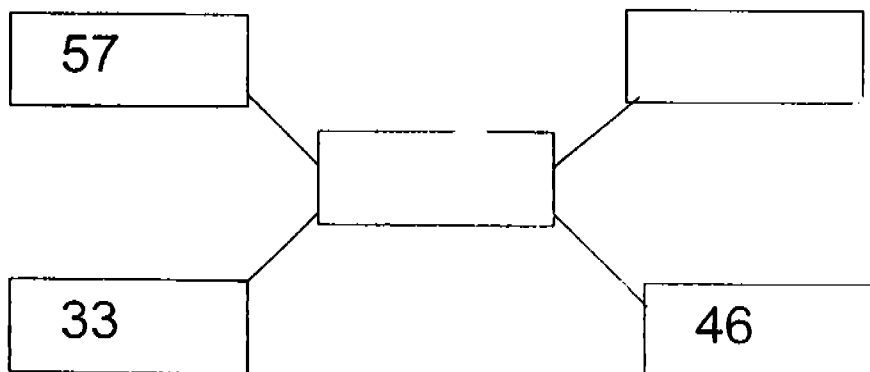

37. Add up the lengths of all the three lines given below and half the total. What is the answer?

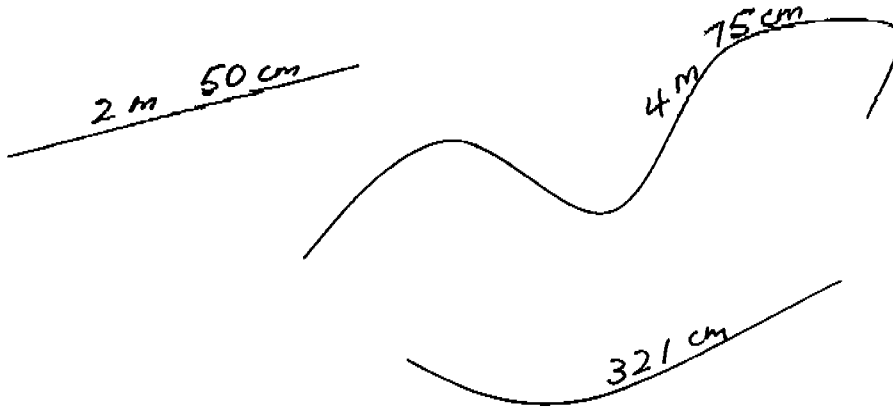

_____ m _____ cm

38. Two papayas of equal mass weigh 2800 g. Draw an arrow to show the weight of one papaya on the weighing scale.

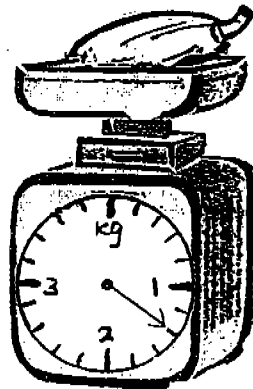

39. A pizza was cut into 5 equal pieces. David and Si Ling ate 2 pieces each. What fraction of the pizza was left?

40. In the figure below, Side X is exactly the same as side Y. Find the perimeter of the whole figure.

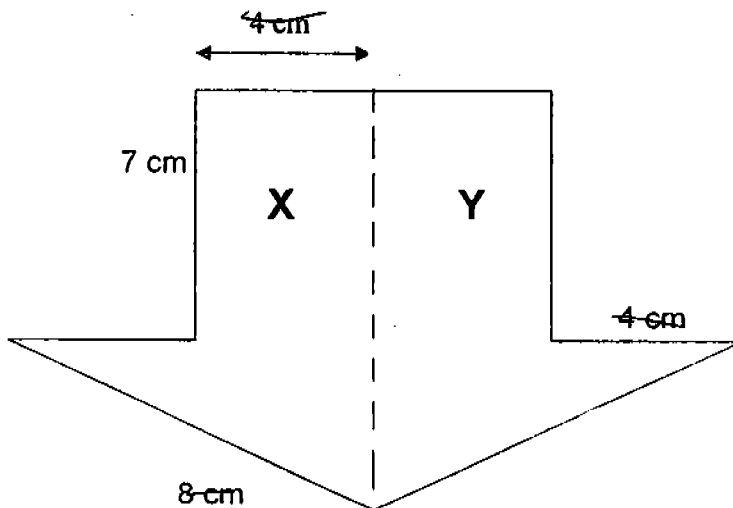
 cm

SECTION C : (20 marks)

For questions 41 to 46, show all your working clearly in the space provided. The number of marks awarded to each question is shown in brackets at the end of the question.

41. Mary had 69 boxes of chocolate left after she had sold 110 boxes. If there were 6 pieces of chocolate in each box, how many pieces of chocolate had she at first? (3 m)
42. Mavis took 2h 10 min to complete her homework while Vanessa took only 80 min to complete the same piece of work. How much longer time did Mavis take than Vanessa ? (3 m)
43. There were 136 books on the first shelf of a library cupboard and two times that number of books on the second shelf. Find the total number of books on the two shelves. (3 m)

44. Figure ABCD below is made up of 3 rectangles of the same area.
Find the area of one rectangle. (3 m)

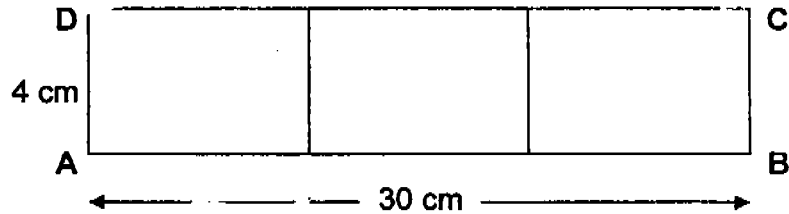

45. Miss Lee bought a pair of shoes for \$61.90 and a pair of sandals for \$23.
She gave the cashier two fifty-dollar notes.
How much change did Miss Lee receive from the cashier? (4 m)

46. The figure given below is made up of 12 rectangles of the same size.

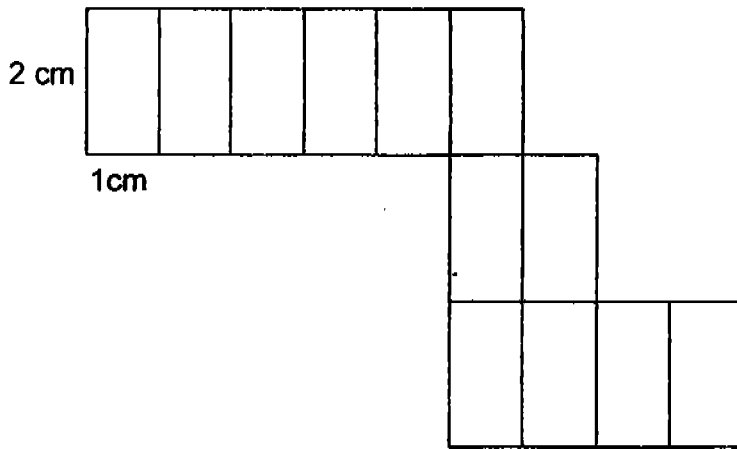

Zen painted $\frac{5}{6}$ of the figure red and the remainder white.

- a) How many red rectangles would there be? (2 m)
- b) Find the total area of the white rectangles. (2 m)

-- END --

Setters: Lim C. C. Belinda Lee

Raffles Girls' Primary School.

Date.

No.

(SA 2 mathematics 2004)

- | | | | | | | | |
|-----|---|-----|---|-----|----------|-----|---|
| 1) | 2 | 11) | 3 | 21) | Tens | 31) | 2 h 15 min |
| 2) | 3 | 12) | 1 | 22) | 665 | 32) | 3 h 00 min |
| 3) | 2 | 13) | 2 | 23) | 2416 | 33) | 4 |
| 4) | 1 | 14) | 3 | 24) | 5 km 4 m | 34) | 2 |
| 5) | 2 | 15) | 4 | 25) | 950 | 35) | 2400 |
| 6) | 3 | 16) | 3 | 26) | 3 | 36) | 79 / ²² |
| 7) | 1 | 17) | 1 | 27) | 110 | 37) | 5 m 23 cm |
| 8) | 1 | 18) | 1 | 28) | 40 | 38) |  |
| 9) | 2 | 19) | 4 | 29) | 1880 m | | |
| 10) | 3 | 20) | 3 | 30) | 20 | | |

39) $\frac{1}{5}$

40) 46 cm

41) she had 1074 pieces

42) Mavis took 50 min more

43) The total number of books on the two shelves are 408

44) $30\text{cm} \div 3 = 10\text{cm}$

$4\text{cm} \times 10\text{cm} = 40\text{cm}$

45) $\$61.90 + \$23 = \$84.90$

$\$50 \times 2 = \100

$\$100 - \$84.90 = \$15.10$

46 a) 10 red rectangles

b) 4cm^2