

[BLANK PAGE]

1

Section A

Please refer to the Leaflet for use with Question 1.

Study the “Insight” leaflet.

State **three design elements** that have been **applied** to the leaflet and describe the effect produced by each.

1.

2

Describe, with the aid of thumbnail sketches, the DTP terms listed below.

Term: **Orphan**

Description

1.

2

Term: **Text Runaround**

Description

2.

2

Term: **Bleed**

Description

3.

Total (9)

Total (6)

2

Marks

Marks

A commercially produced design proposal for a promotional leaflet is shown below.

- (a) In the position indicated, produce an alternative **full size** visual design using your knowledge of Design Principles.

5

- (b) Identify and describe **two** Design Principles used in your alternative design describing the impact they had on your design.

Design Principle used

Description of impact



Design Principle used

Description of impact

4

Total (9)

4

A 3D CAD solid model of a component is shown. With the aid of sketches, explain how this 3D CAD solid model of the component will be produced.

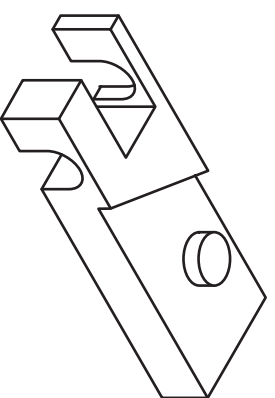

Marks

5

Three commercial printing processes are given below.

- Lithography
- Screen Printing
- Flexography

For each printing process, state an advantage and an appropriate application.

Section A
Marks

Lithography

Advantage

Application

Screen Printing

Advantage

Application

Flexography

Advantage

Application

Total (5)

Total (6)

The elevation and plan of a monument are given below:

The spectator point (SP), plane of projection (PP), ground line (GL) and eye level (EL) are also given.

Draw, from the given views, a measured perspective view of the monument.

Do not show hidden detail.

(16 marks)

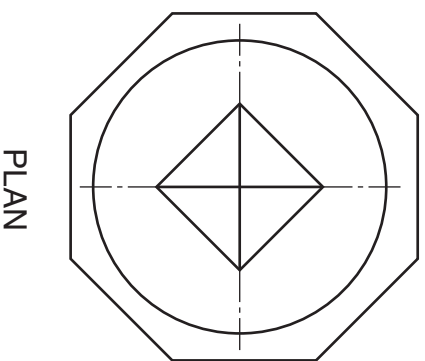

PLAN

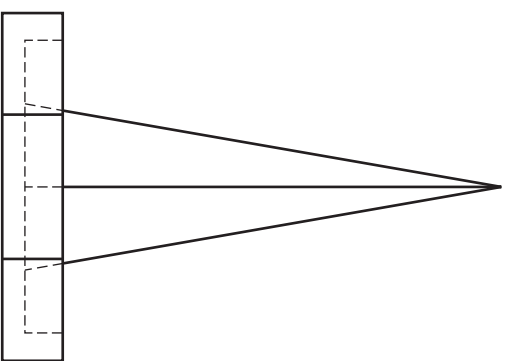

ELEVATION

[X033/701]

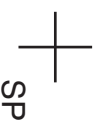
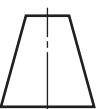
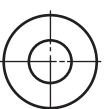
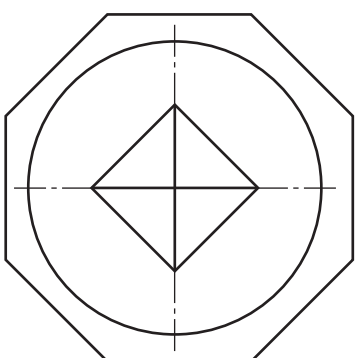

SP

PP

GL

EL

a	
b	
c	
d	
e	
f	
g	
h	
i	
j	
k	
l	
m	
n	

7 The elevation and plan of interpenetrating square and triangular pipes are given.

Draw, in the position shown:

- (a) the complete end elevation;
 - (b) the complete surface development of the square pipe starting at **XX**.
- Include hidden detail in (a). (13 marks)**

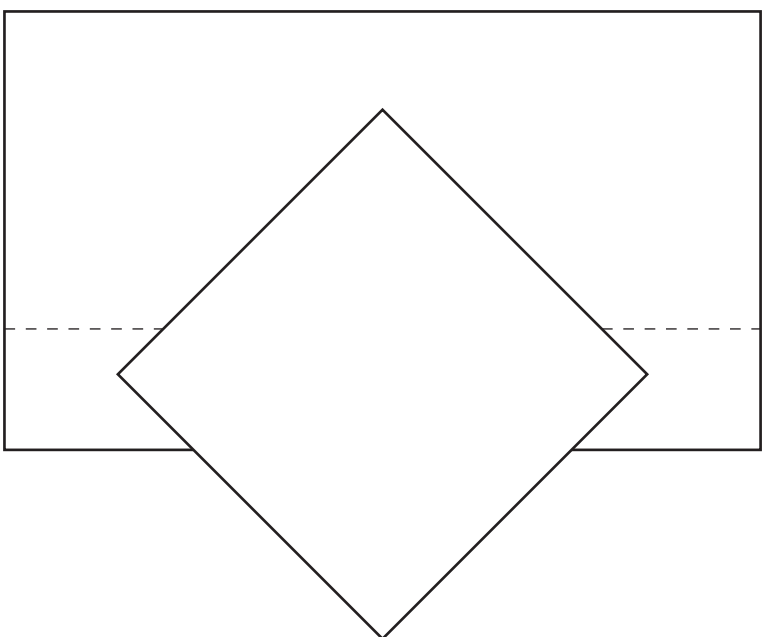

PLAN

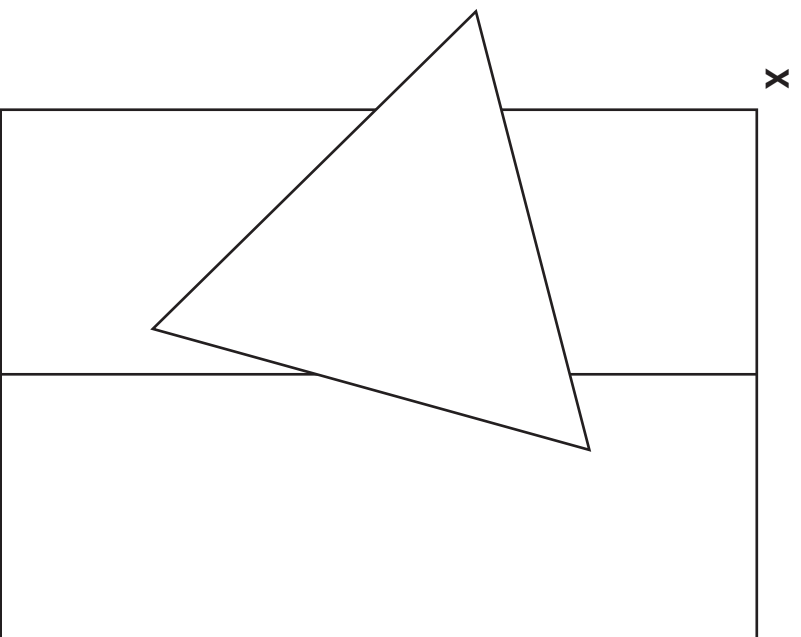

ELEVATION

END ELEVATION



X

DEVELOPMENT

X

<i>a</i>	
<i>b</i>	
<i>c</i>	
<i>d</i>	
<i>e</i>	
<i>f</i>	
<i>g</i>	
<i>h</i>	
<i>i</i>	
<i>j</i>	
<i>k</i>	
<i>l</i>	
<i>m</i>	
<i>n</i>	

The elevation of a solid oblique cone is given.

Draw:

- (a) the complete plan;
- (b) the surface development of the curved surface starting in the position indicated at O.

Show hidden detail in (a).

(16 marks)

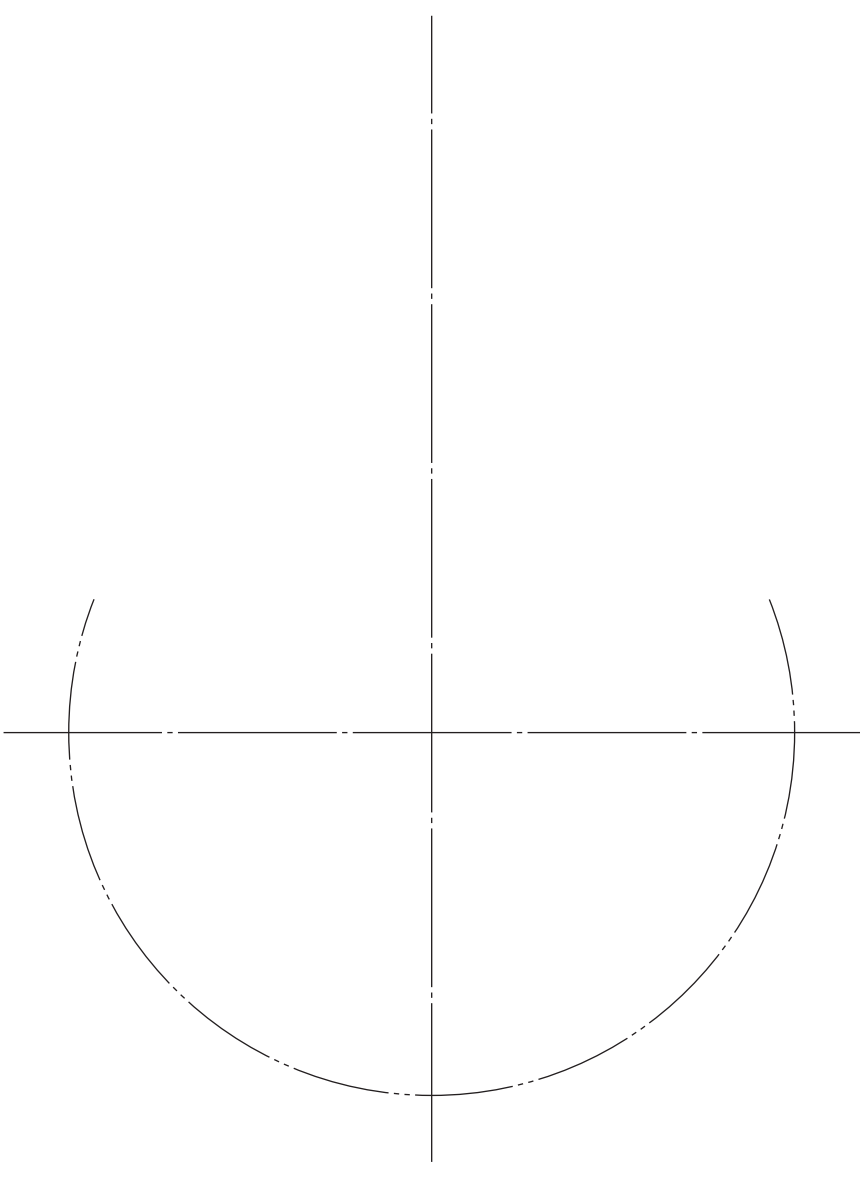

PLAN



a	
b	
c	
d	
e	
f	
g	
h	
i	
j	
k	
l	
m	
n	

DEVELOPMENT

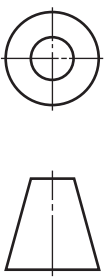

ELEVATION

ACKNOWLEDGEMENTS

Leaflet for use with Question 1—Full page spread, “Insight”, is taken from Pages 6 and 7 of *Prudential Magazine, Autumn 2006*. Permission is being sought from Publicus Blueprint.

Question 3—Picture of a Snolzone Braehhead leaflet is reproduced by kind permission of Snolzone Scotland.

X033/702

NATIONAL
QUALIFICATIONS
2009

THURSDAY, 28 MAY
9.00 AM – 12.00 NOON

GRAPHIC
COMMUNICATION
ADVANCED HIGHER

Leaflet for use with
Question 1



NEWS

Insight

Recent research, fascinating facts, snippets and great prizes – your news starts here



Brain needs a boost?

Good news for chocoholics! Once again, scientists have given cocoa flavanols – natural compounds found in cocoa beans – their seal of approval. A study at Nottingham University found that chocolate not only boosts brain power, but could also help stroke patients. All it takes is 150mg of cocoa flavanols for five days to increase the blood flow to the brain. A daily hot chocolate might just be what the doctor orders.



DID YOU KNOW?
A third of the average UK spending on food goes on convenience food*



*Source: Mintel, *Dieting* Jan 06

FASHIONABLE SOLUTION

With our ageing population, it's once again stylish (and useful) to have a granny annexe attached to the house. Indeed the property pages are full of ads offering a 'des res' with self-contained annexe. The good news is that an annexe is exempt from council tax (the ruling changed in 1997), provided it's occupied by a family member over 65; however, this tax break doesn't apply to Scotland. An uber-modern alternative to a granny flat is one of the newer Scandinavian exports, which puts granny in a cabin in the garden. And at roughly £26,000 for these deluxe Wendy houses, she can hardly complain.



IMAGES: Robert Daly, David Woolley/Getty Images, Lennette Newell/Photolibrary.com

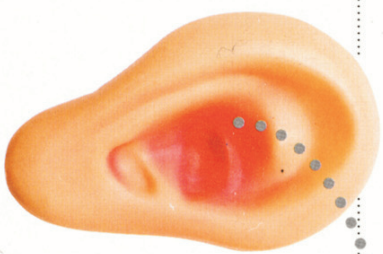

The power of podcasts

Such is the success of the podcast that leading legal publisher Sweet & Maxwell is offering law students free podcasts to help them revise, with updates on the latest legal developments. These audio recordings can be delivered via iPod, computer or phone. Not a new idea (Pru's latest podcast, *Retirement essentials – 10 things to do when you retire*, is on www.pru.co.uk), but a fun, new-tech way of delivering info that – especially in the case of law – must be learned drearily by rote.

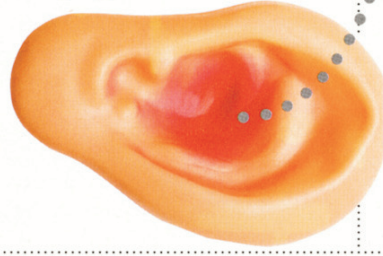

Women at risk

The sad fact is that only a third of women in the UK save for a pension. This doesn't bode well for a happy, cushioned retirement. In fact, according to a recent survey for Investec, of those women who have a pension, fewer than half think they'll have enough income in retirement. And many expect to have to work longer into retirement to make up the deficit. What holds many women back from saving is that they use any extra income they have on their children. While the Government recently revealed in a White Paper that it will try to address the problem of pension reform, the challenge may be an emotional one.

Says independent adviser Julie Hedge, "Women tend to spend their money on their families. Men are more tuned in to the importance of pension saving and are likely to have company pensions. But women overlook retirement savings at their peril." The best advice from any quarter is: it's never too late (see Prudential's contributions calculator at www.pru.co.uk).



WIN! A luxury 12-day European river cruise

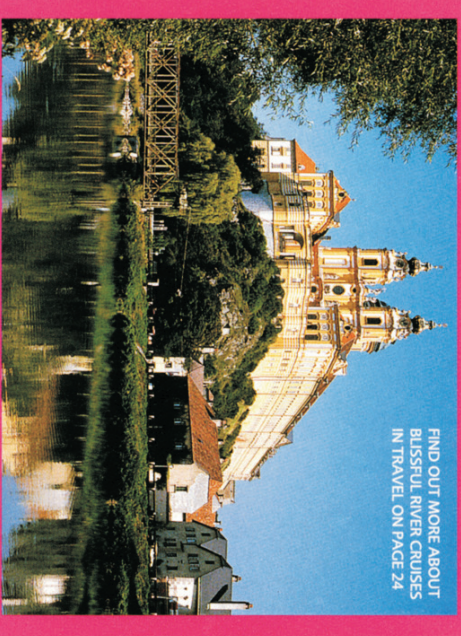

FIND OUT MORE ABOUT BLISSFUL RIVER CRUISES IN TRAVEL ON PAGE 24

Prudential has teamed up with Page & Moy (www.pageandmoy.com or 0870 010 6434) to offer one lucky reader and a guest (aged 18 or over) a relaxing River Cruise on the Rhine, Main and Danube. You'll have a twin cabin on the Mozart deck of the stylish 4-star *MV Serenade I* as you meander along these great rivers. Built to the highest standards of safety and design, the *MV Serenade I* offers something for everyone. Return flights from London Heathrow and all meals on board ship are included in the prize.

TO ENTER: Visit www.pru.co.uk/magazine and click on the Win! link. Or send your details on a postcard to: Cruise Break, Prudential Magazine, Packmill, Presley Way, Crownhill, Milton Keynes MK8 0ES. Closing date: 30 November 2006.



Oh, the poor puppy!

There's a revolution going on in all the Ricky Gervais-style offices across the country. Corporate speak is imploding from a whole new vocabulary. Just when we've mastered **blue skies approach** and **monkey on your back**, academic Tony Thorne, author of *Shoot the Puppy* (Penguin, £12.99), says we have to learn new buzz phrases, such as **deskfast shuffle** (moving a difficult colleague into a position where they can't do any harm) and **knife-and-fork it** (dismantle an issue). And then there's **shoot the puppy** (doing something so radical it seems unthinkable). Pity the puppy...