

HENRY PARK PRIMARY SCHOOL

P6 PRELIMINARY EXAMINATION

2007

SCIENCE

PRIMARY 6

BOOKLET A

Name: _____ ()

Class: Primary 6 _____

**30 Questions
60 Marks**

Total Time for Booklets A and B: 1 h 45 min

DO NOT OPEN THIS BOOKLET UNTIL YOU ARE TOLD TO DO SO.

READ AND FOLLOW INSTRUCTIONS CAREFULLY.

PART 1 (60 marks)

For each question from 1 to 30, four options are given. One of them is the correct answer. Make your choice (1,2, 3 or 4). Shade the correct oval (1,2,3 or 4) on the Optical Answer Sheet.

1 At which stage of the life cycle of a mosquito can it be killed by spraying oil on the surface of the water?

- A egg stage
- B larval stage
- C pupal stage
- D adult stage

- (1) A and B only
- (2) B and C only
- (3) A, B and C only
- (4) A, B, C and D

2 The diagram below shows a plant cell.

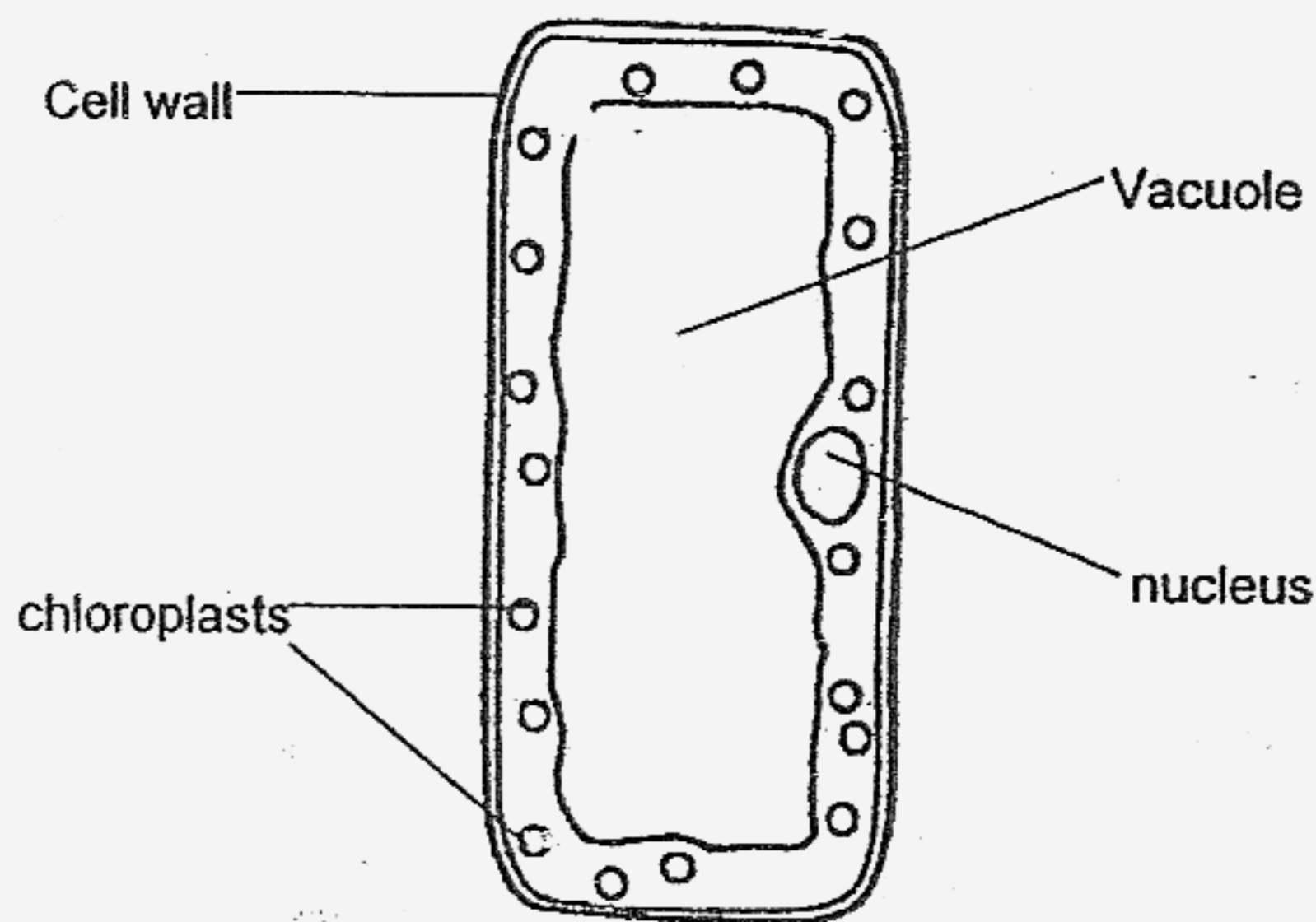

Which one of the following parts of a plant is the above cell likely to be found?

- (1) flower
- (2) fruit
- (3) leaf
- (4) root

- 3 Melissa planted some green bean seeds in Pot A and Pot B as shown in the diagram below. The pots are placed in the open space so that the pots are exposed to the same amount of sunlight. The same amount of water and soil are also given to each pot.

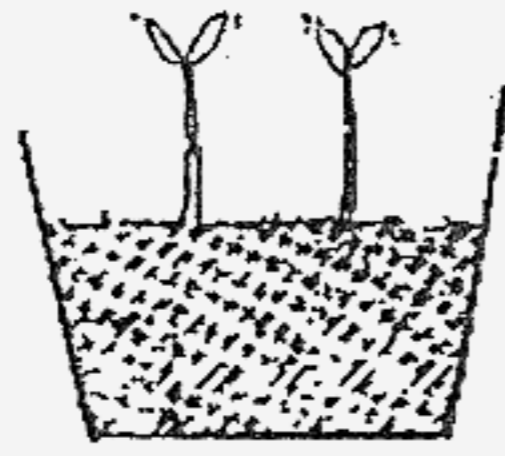

Pot A

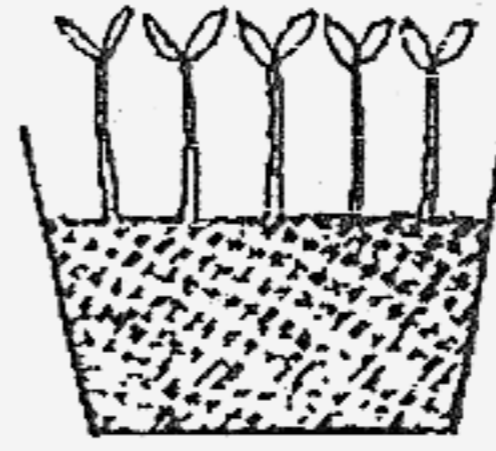

Pot B

Each day she recorded the average height of the plants in each pot and plotted the heights of the plants on a graph.

Which one of the following graphs shows the likely average heights of the plants in Pot A and Pot B correctly ?

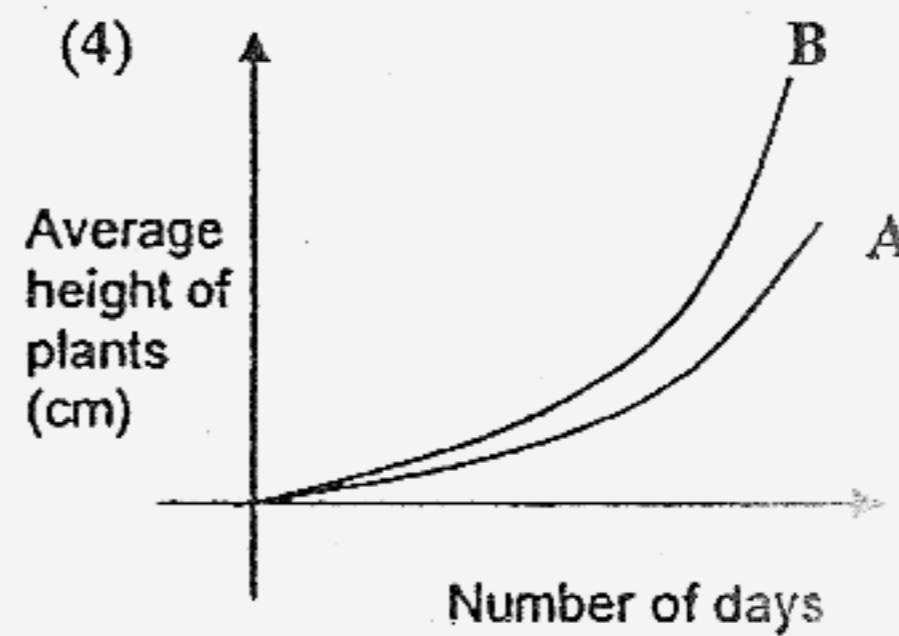
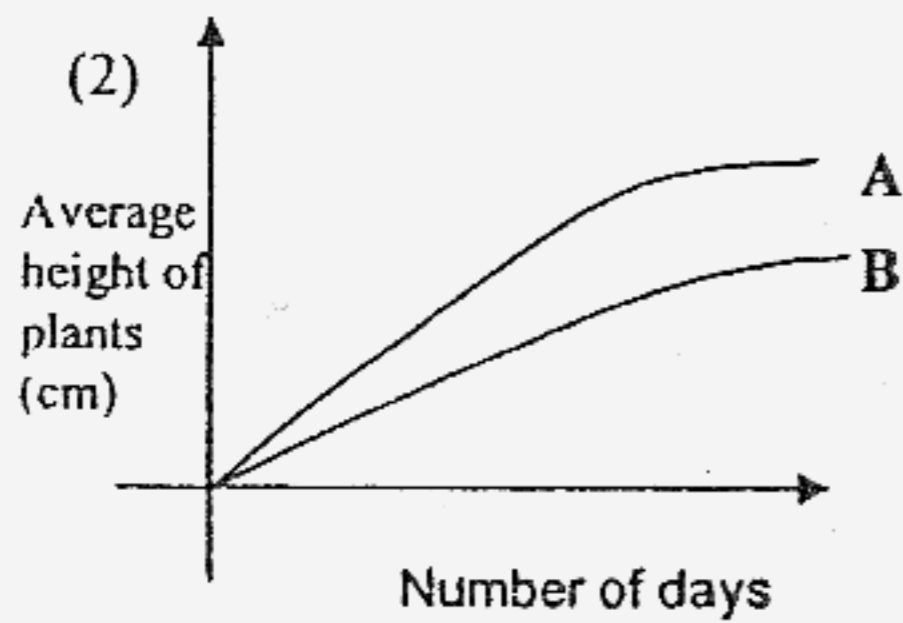
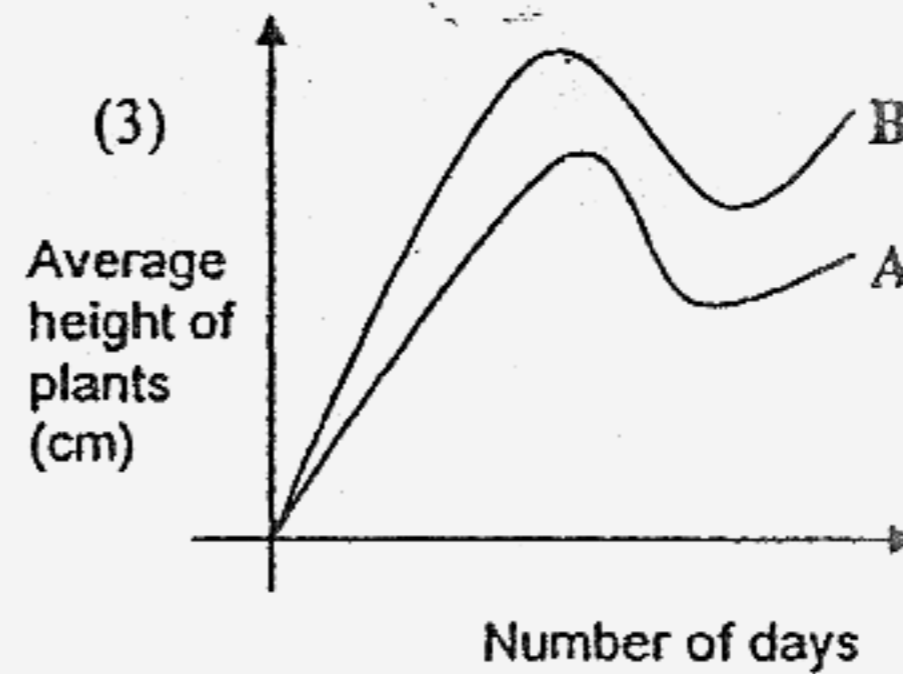
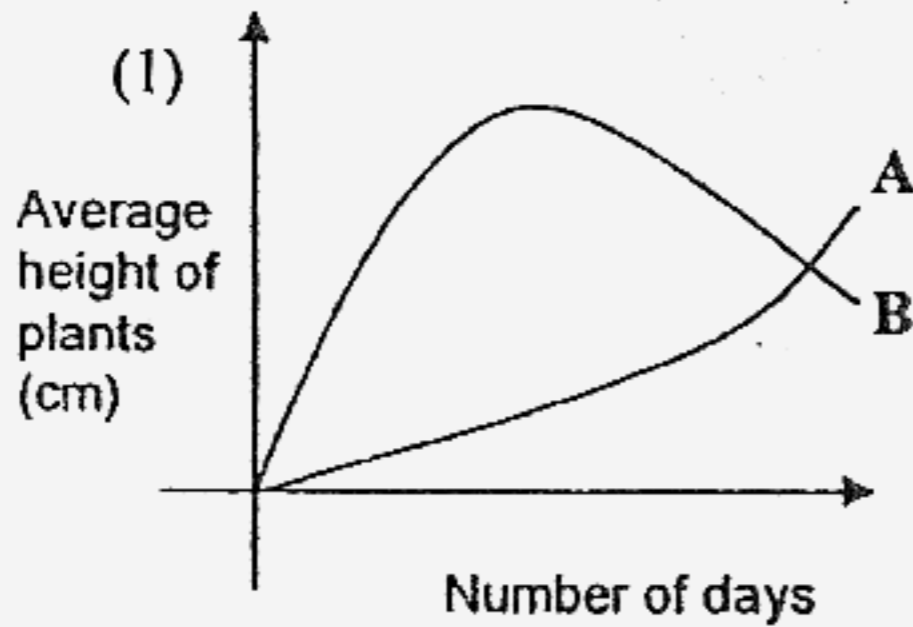

4 Each group of pupils were given several objects to classify. The chart below shows how Group 4 had classified their objects.

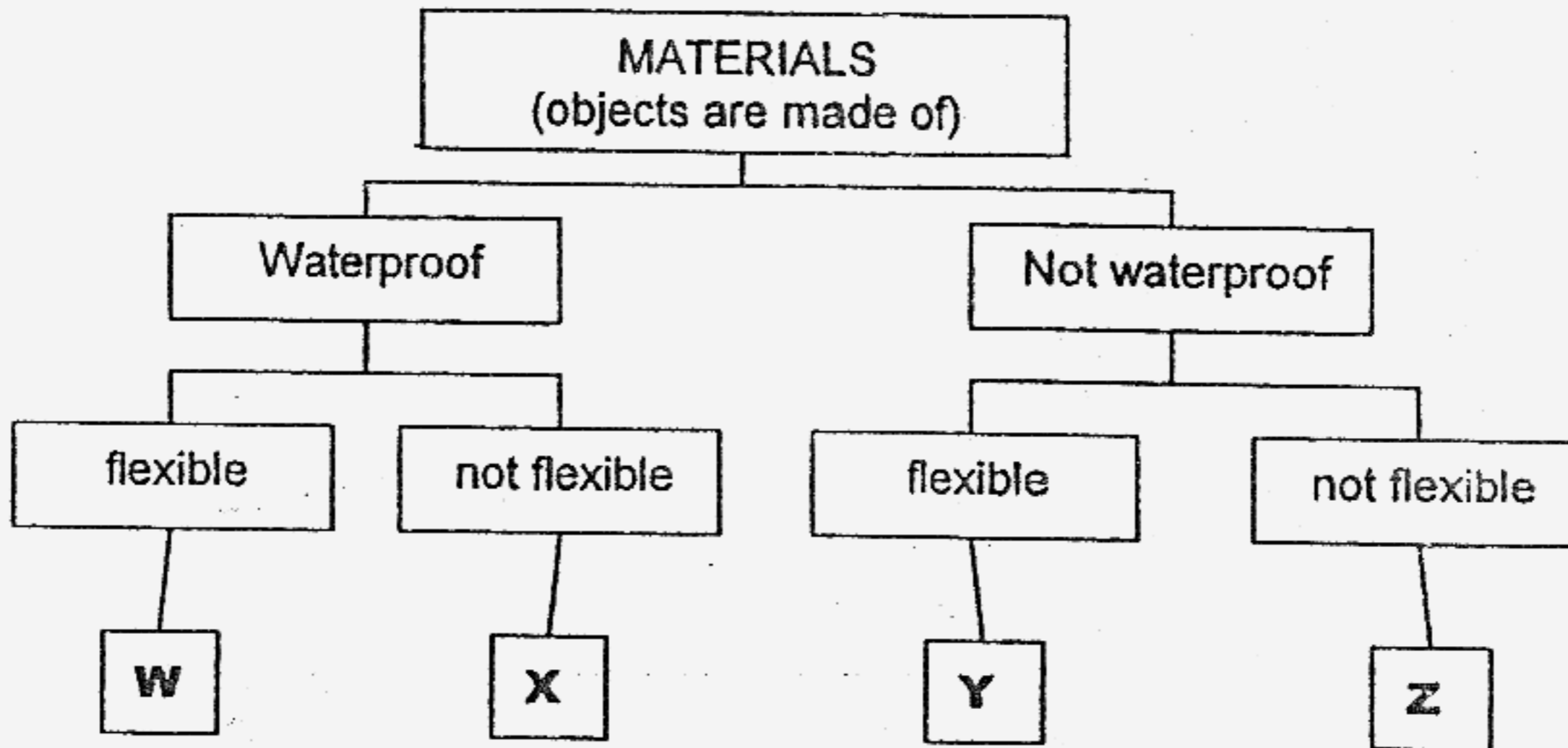

What materials are W, X, Y and Z likely to be?

	W	X	Y	Z
(1)	rubber	glass	wool	wood
(2)	plastic	wood	cloth	metal
(3) f	clay	metal	wood	cloth
(4) r	wool	ceramic	plastic	clay

5 The diagram below shows the cross section of a flower

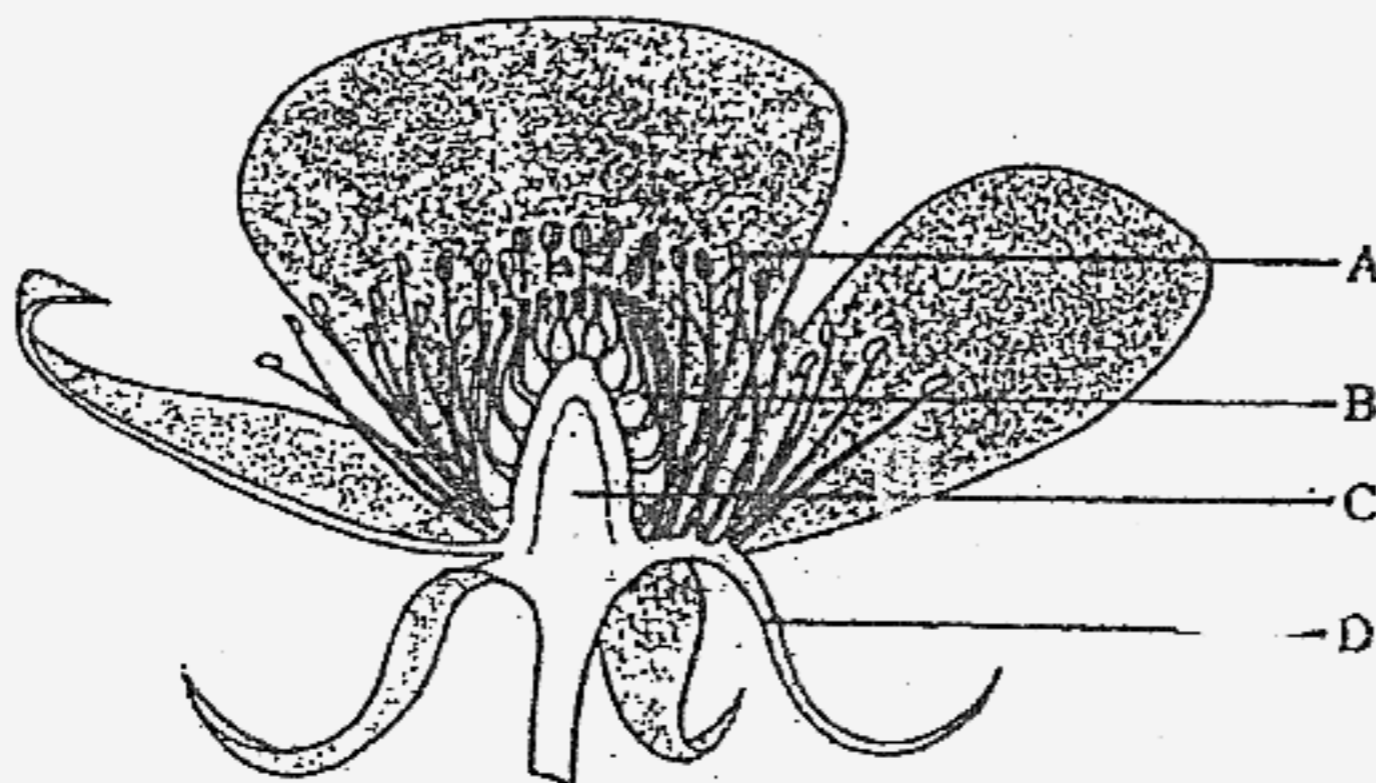

Which two letters show the male and female parts of the flowers respectively ?

	MALE PART	FEMALE PART
(1)	A	B
(2)	A	D
(3)	B	D
(4)	B	C

6 The diagram below shows a sweet potato plant

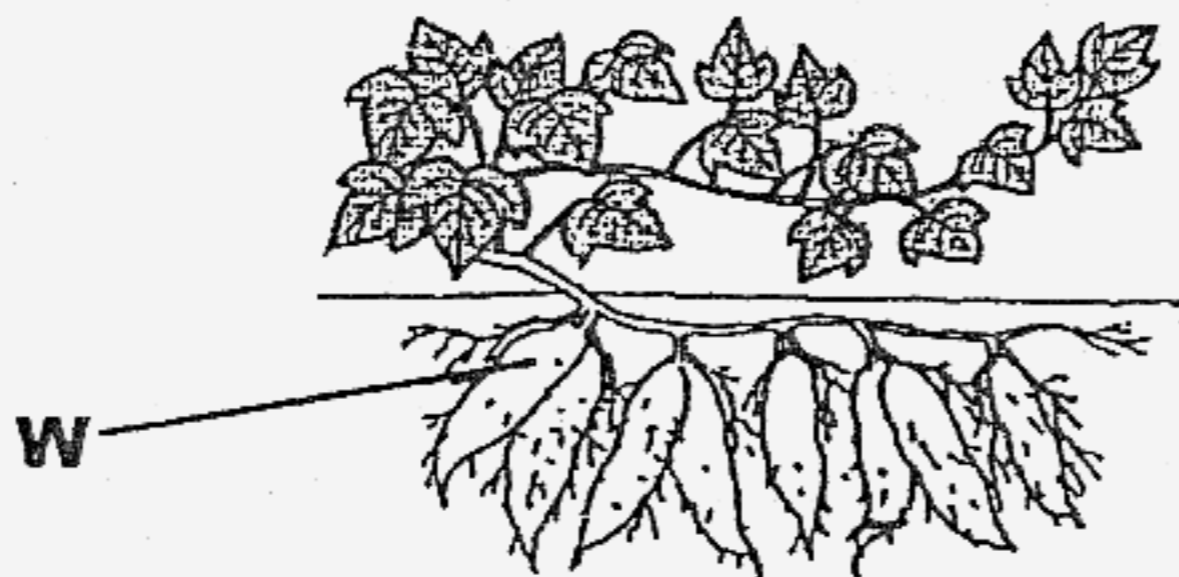

What are the functions of the swollen part marked W ?

- A To help the plant reproduce
- B To take in water for the plant
- C To store excess food made by the plant

- (1) A and B only
- (2) A and C only
- (3) B and C only
- (4) A, B and C

7 What does blood carry to the lungs ?

- A Carbon dioxide
- B Food
- C Oxygen

- (1) A only
- (2) C only
- (3) A and C only
- (4) A, B and C

8 The diagrams below shows our respiratory system and part of our digestive system.

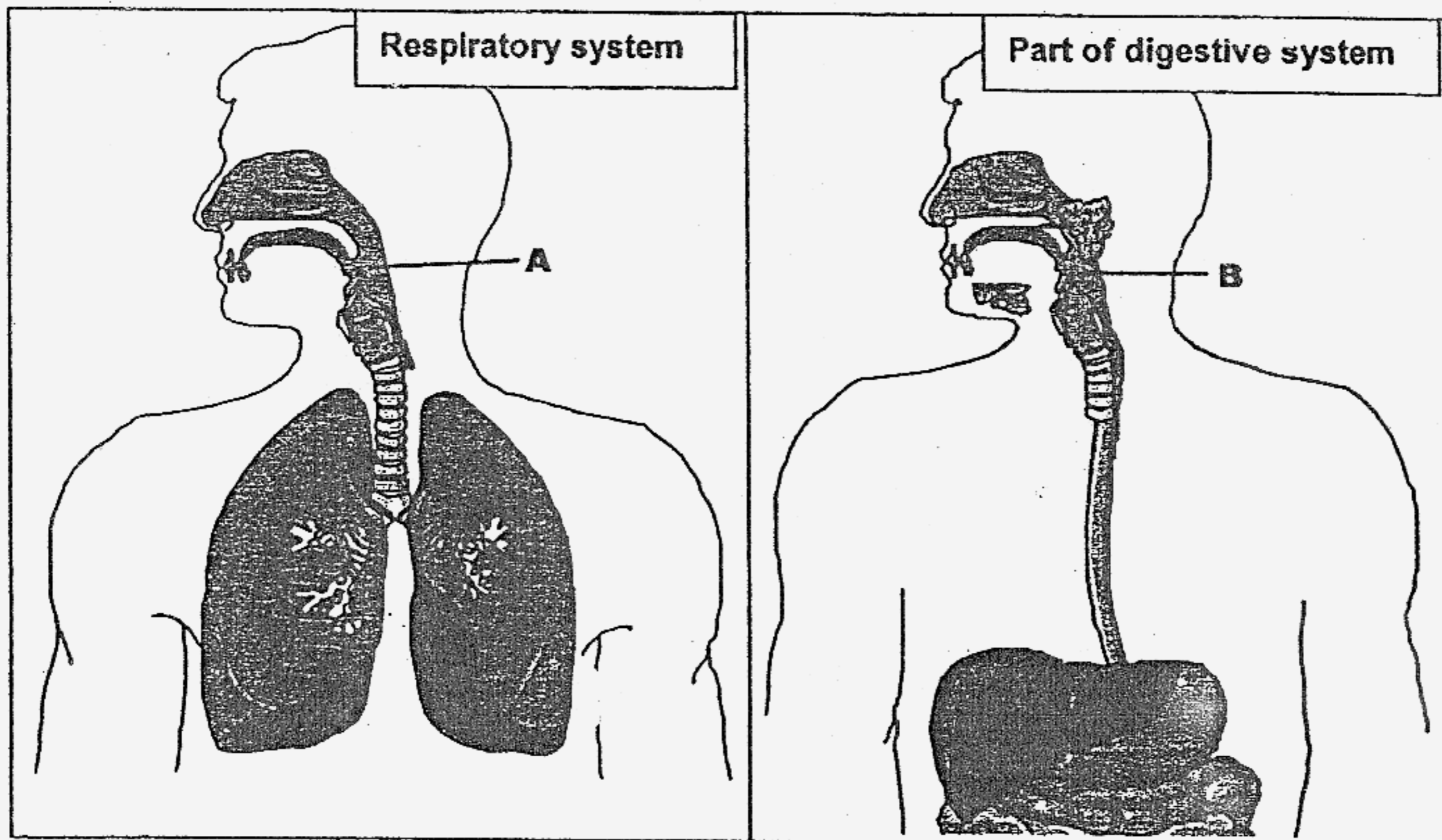

Which of the following statements is/are true for the part marked A in the respiratory system and B in the digestive system?

- A Air passes through A but not through B.
- B Food passes through B but not through A.
- C Food and air passes through both A and B.

- (1) A only
- (2) B only
- (3) C only
- (4) A and B only

- 9 The diagram shows a ribcage.
Which vital organ(s) of the body does the ribcage protect?

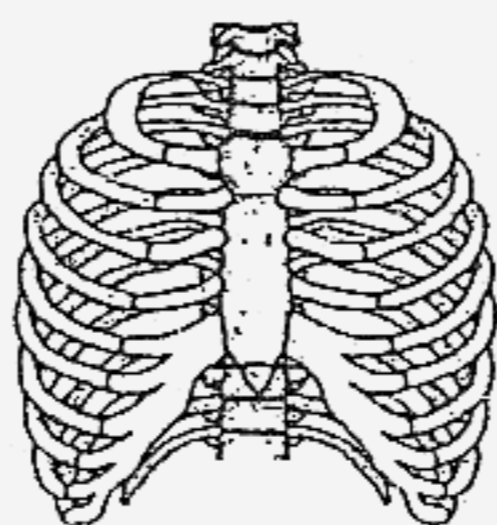

- A heart
- B lungs
- C liver
- D stomach

- (1) B only
- (2) A and B only
- (3) A, B and C only
- (4) A, B C and D

- 10 The diagram shows a skeleton in a sitting position. Which letters show the ball and socket joints?

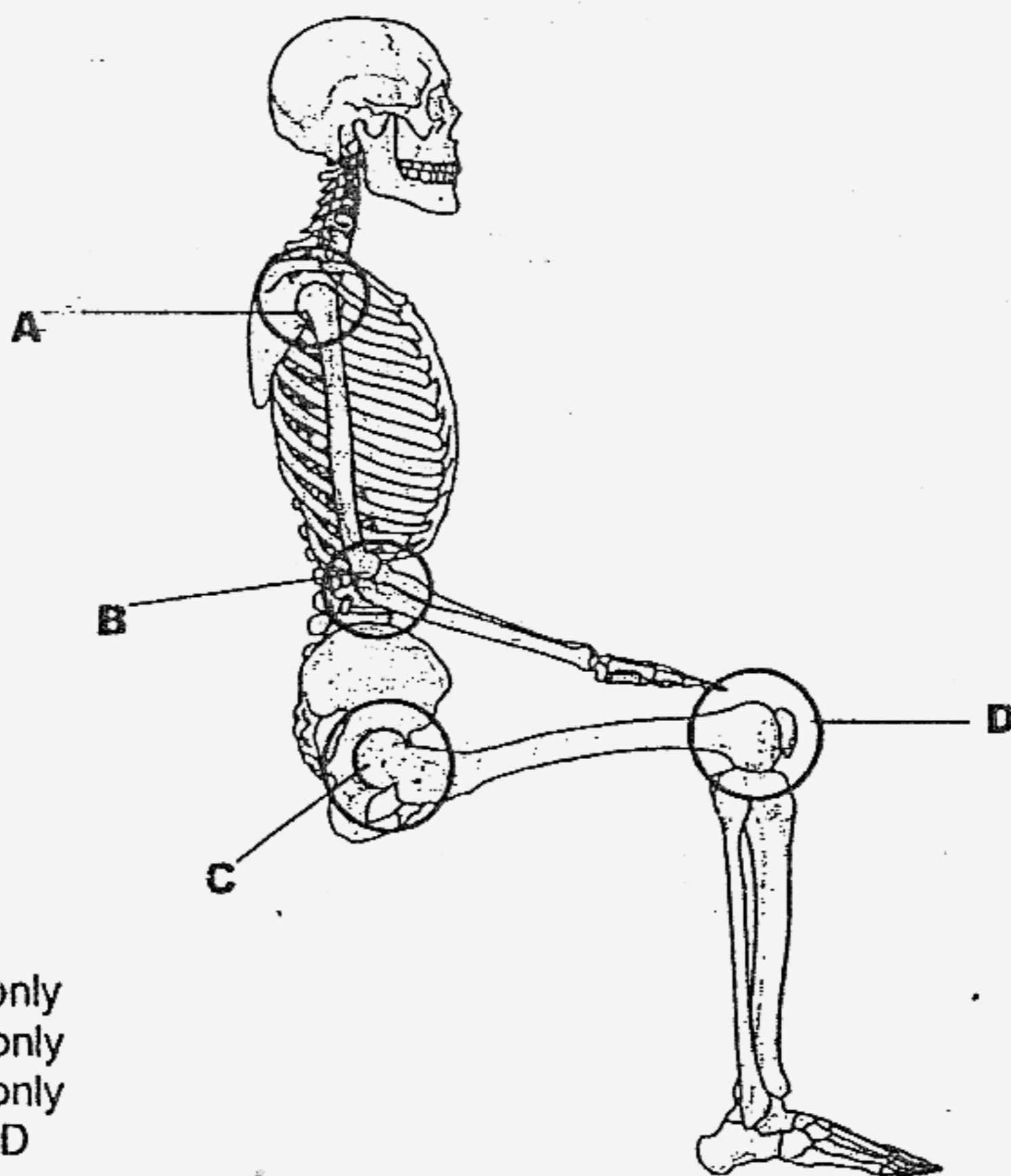

- (1) A and B only
- (2) A and C only
- (3) B and D only
- (4) A, C and D

11 Study the garden food web below.

A Garden Food Web

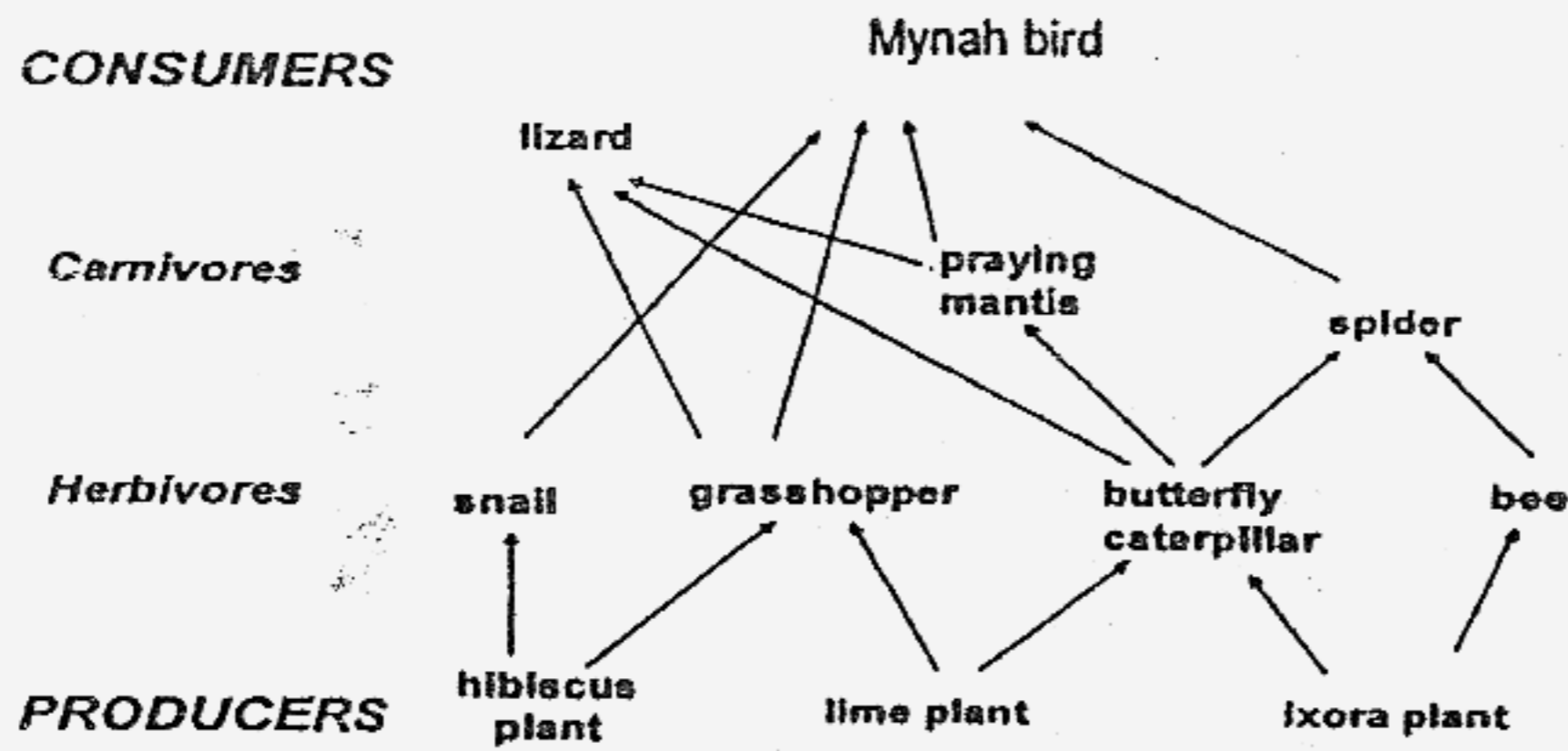

Which one of the following statements is not true about the above food web?

- (1) All the herbivores are preys.
- (2) There are more preys than predators
- (3) There are four food chains with only three organisms in each.
- (4) If the mynah bird population is removed, the plant population will eventually decrease

12 The diagram shows a cross section of a pond .

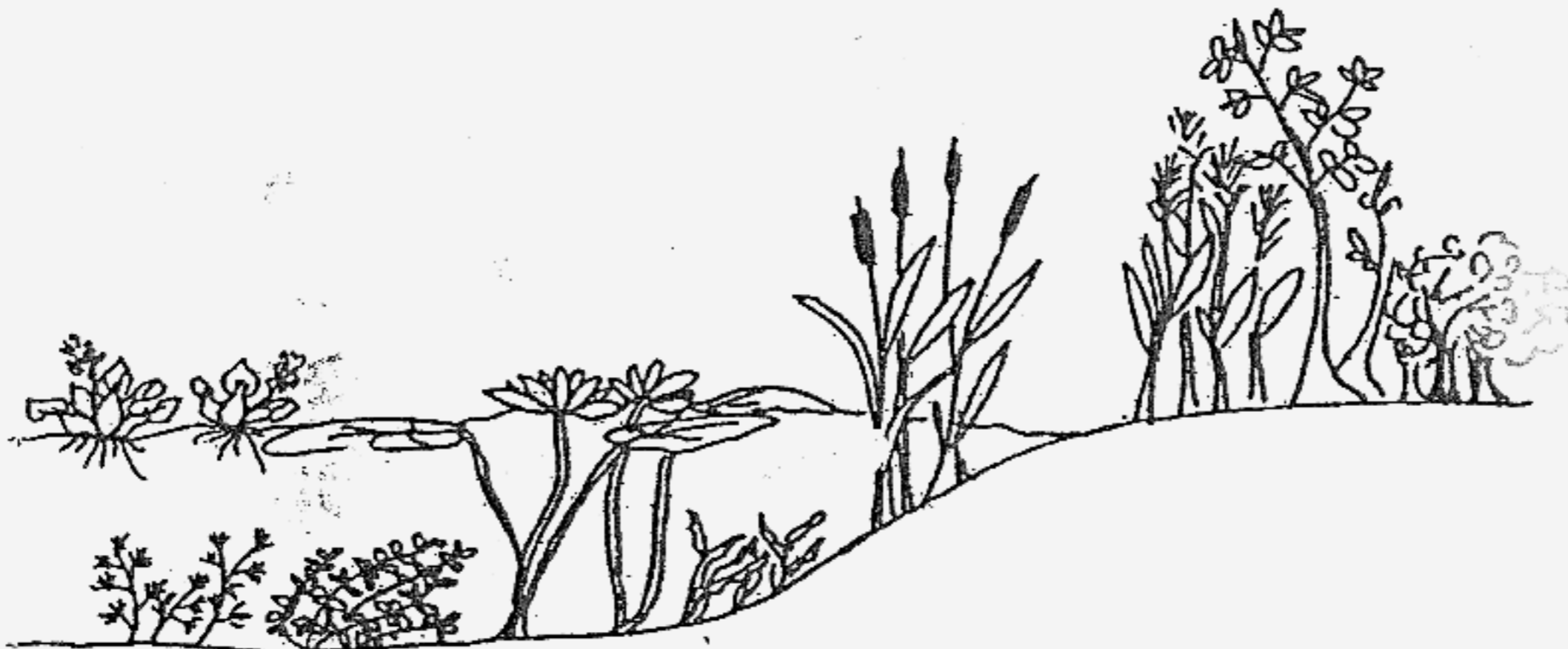

How many populations of aquatic plants are there?

- (1) 6
- (2) 9
- (3) 12
- (4) 15

13. Which one of the following characteristics is not passed on from parents to child?

- (1) Rolling tongue into a U-shape
- (2) Sleeping pattern
- (3) Colour of hair
- (4) Shape of ears

14 The diagram below shows carbon dioxide being taken in or given out during some processes .

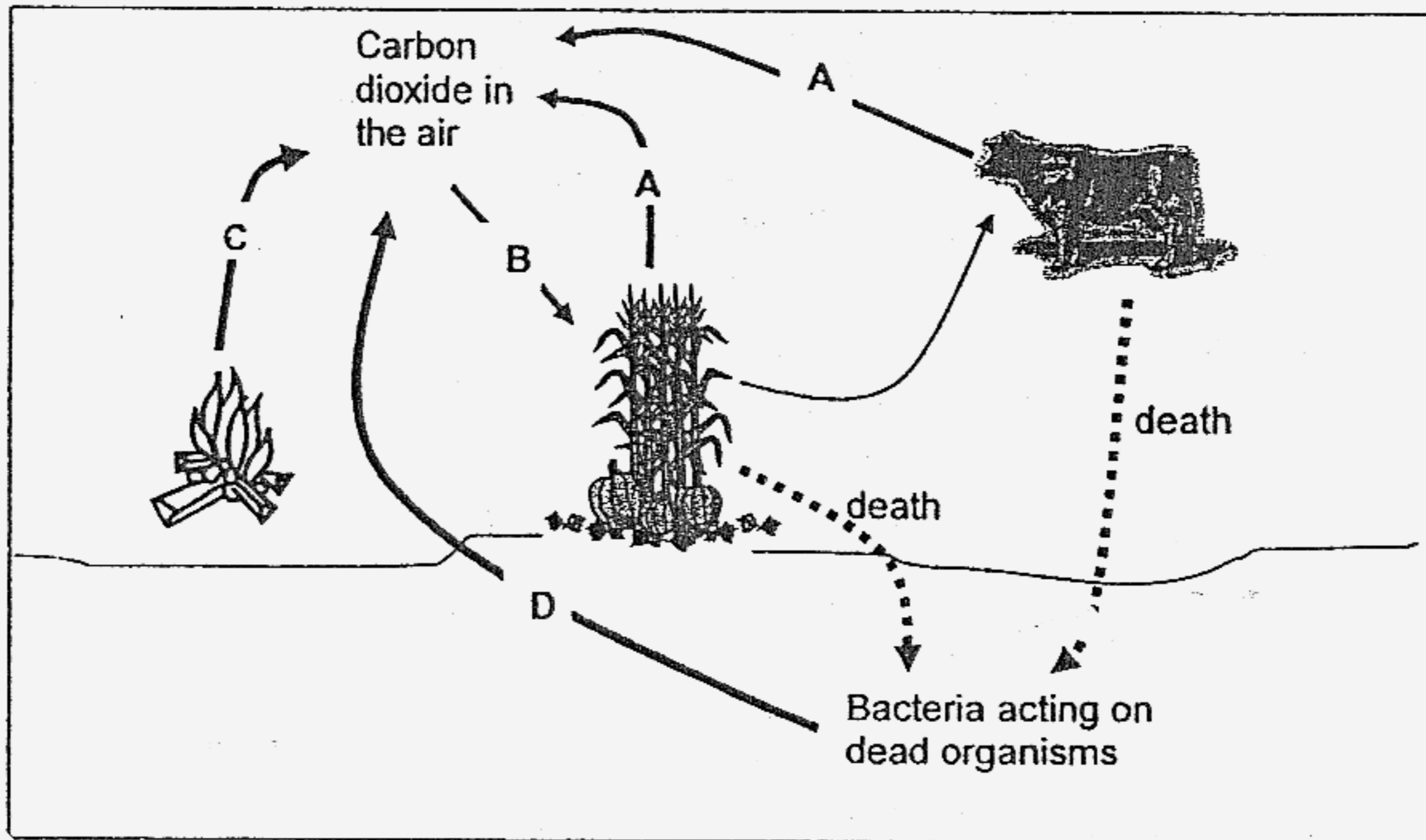

A,B,C and D are four different processes.

Which one of the following options in the table below identifies the Processes A, B, C and D correctly?

	A	B	C	D
(1)	Photosynthesis	Respiration	Burning	Decomposition
(2)	Respiration	Photosynthesis	Burning	Decomposition
(3)	Photosynthesis	Burning	Decomposition	Respiration
(4)	Decomposition	Respiration	Photosynthesis	Burning

- 15 An experiment is set as shown in the diagram to find out whether carbon dioxide is needed for photosynthesis.

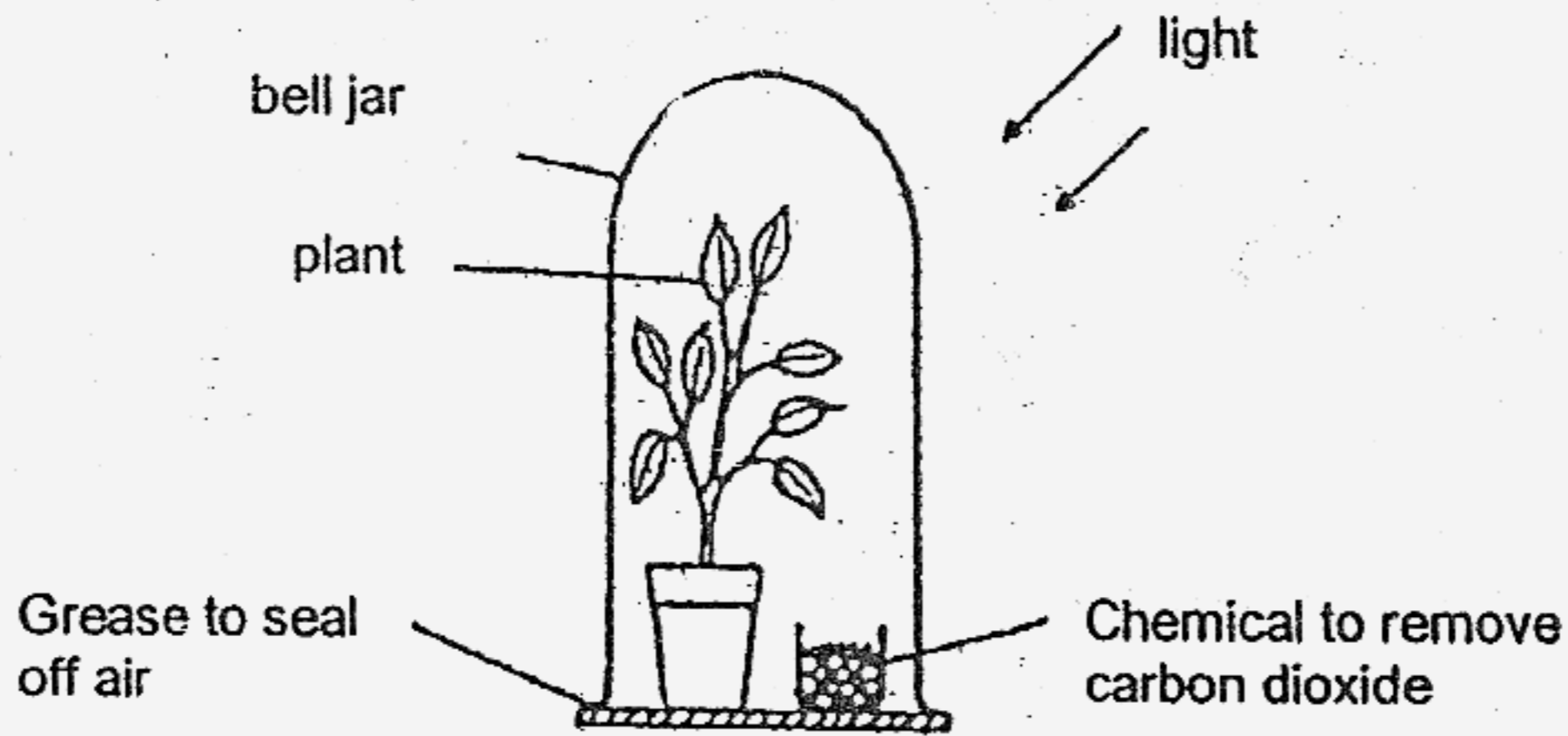

Temperature of surrounding : 29°C

Which one of the following set-ups is the most suitable control for the above experiment ?

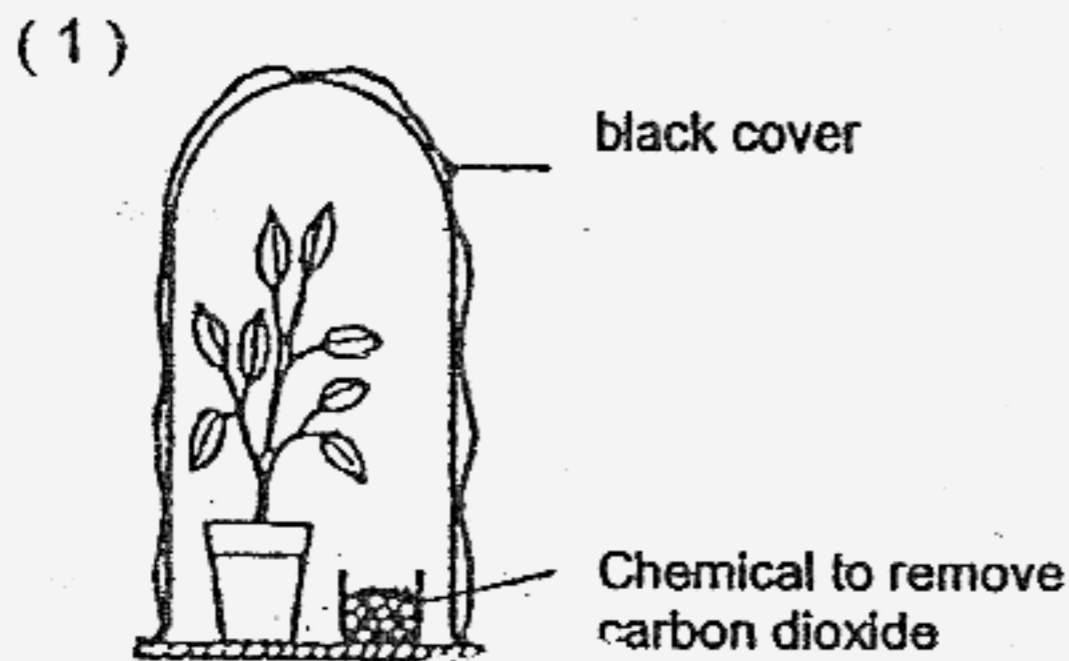

Temperature of surrounding : 29°C

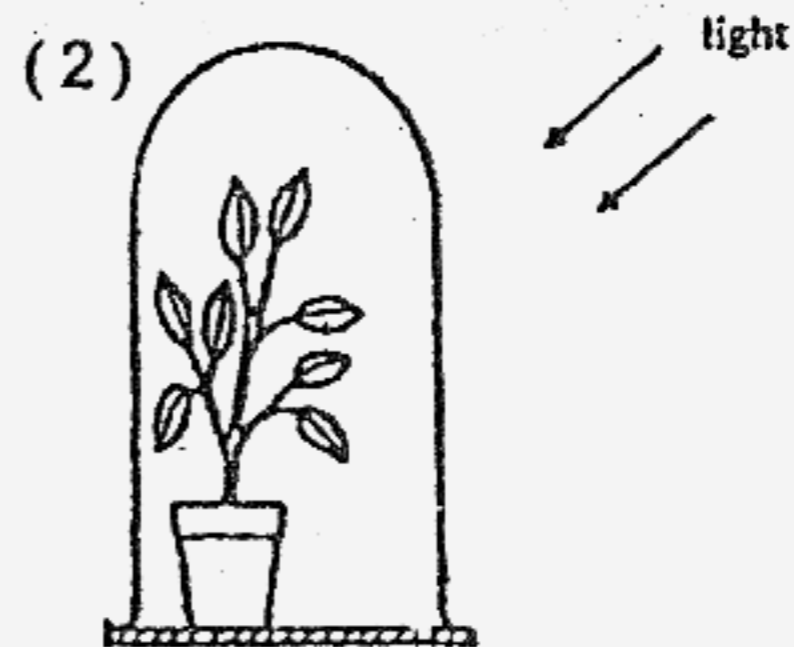

Temperature of surrounding : 29°C

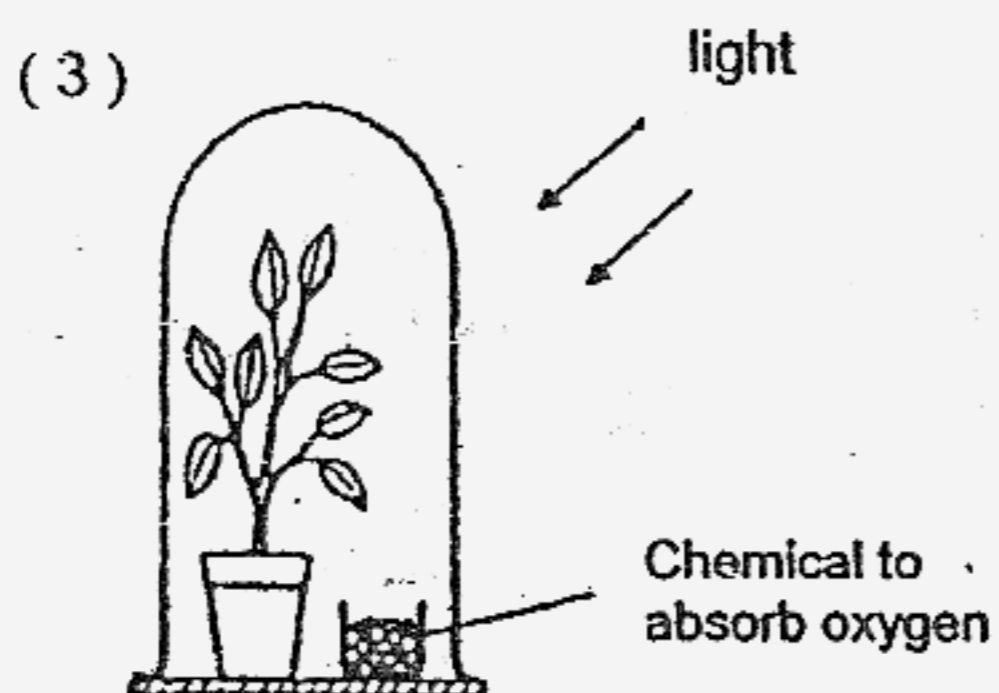

Temperature of surrounding : 29°C

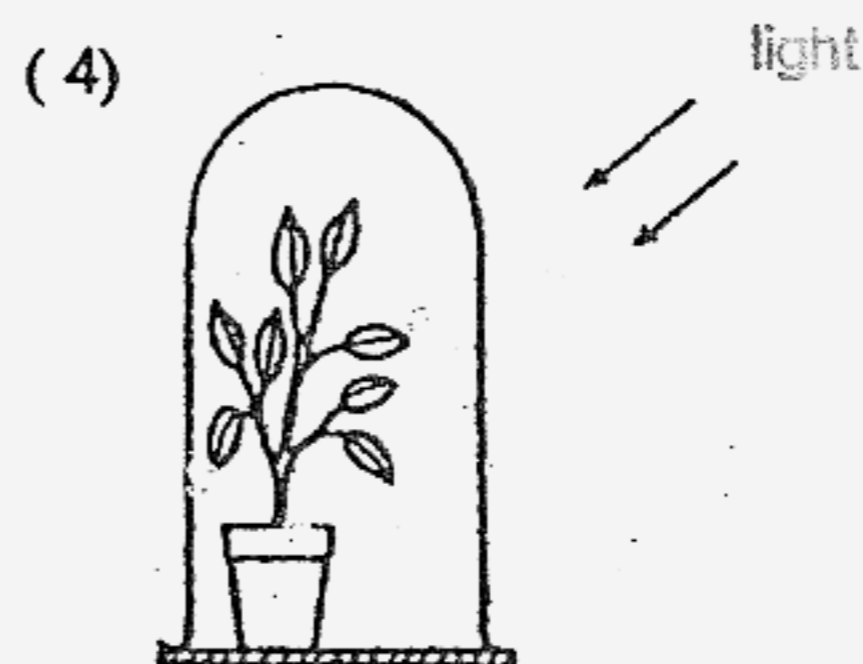

Temperature of surrounding : 32°C

16. The table below shows the melting points and boiling points of substances X, Y and Z respectively.

Substance	Melting point / °C	Boiling point / °C
X	41	83
Y	27	66
Z	58	95

At which one of the following temperatures are the three substances X, Y and Z, in the same state?

- (1) 32 °C
 - (2) 49 °C
 - (3) 60 °C
 - (4) 81 °C
17. Mary dried three identical towels containing the same amount of water in the balcony. Each towel was folded to expose a different amount of surface area. After five hours, each towel was weighed. She recorded her results and plotted them on a graph.

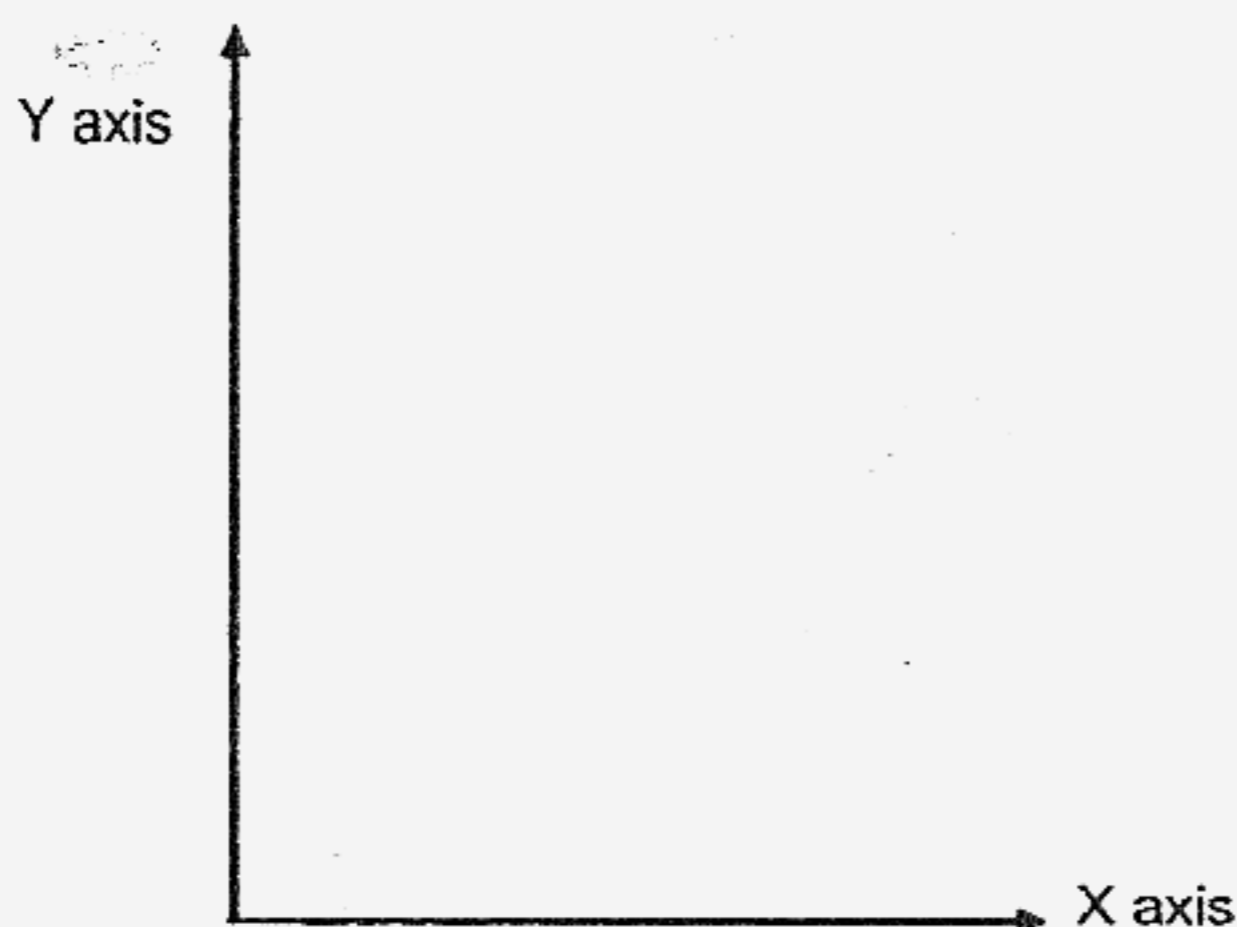

Which one of the following pairs of labels is most suitable for the x and y axis of the graph she plotted with her results?

	Y axis	X axis
(1)	Mass of towels	Surface area of towels
(2)	Time taken	Surface area of towels
(3)	Surface area of towels	Time taken
(4)	Mass of towels	Time taken

18. Which of the following statements about the Earth is/are correct?

- A The Earth is a natural satellite of the Moon.
- B The four seasons are caused by the Earth spinning about its axis.
- C The Earth takes about 365 days to orbit around the Sun.

- (1) B only
- (2) C only
- (3) A and C only
- (4) A,B and C only

19. Paul looked at the Moon on different nights and recorded what he saw below.

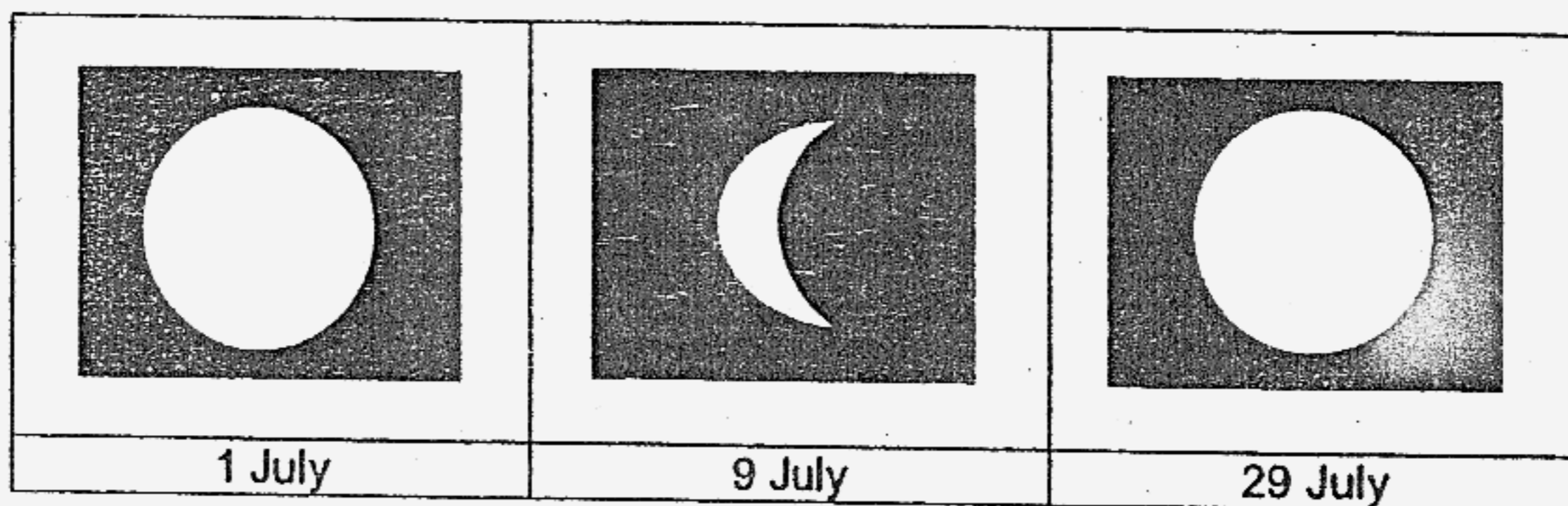

The moon most probably could not be seen on _____.

- (1) 2 July
- (2) 10 July
- (3) 15 July
- (4) 30 July

20. Darren used two ramps, P and Q, to push an identical box up to the same height. He observed that the effort needed to push the box up ramp Q was greater than the effort needed for ramp P.

What possible conclusions can he make about ramps P and Q?

- A Ramp Q is shorter than ramp P
- B Ramp P is steeper than ramp Q.
- C Ramp P has a smoother surface than ramp Q.

- (1) A and B only
- (2) A and C only
- (3) B and C only
- (4) A, B and C

21. The table below compares Planet V and Planet W.

	Planet V	Planet W
Time taken to complete 1 rotation about its axis	243 days	1 day
Time taken to complete 1 revolution	225 days	365 days
Direction of spin around axis	Clockwise	Anticlockwise

Based on the information above, which of the following statements is/are definitely true?

- A Planet V has a shorter year than Planet W.
 B Planet V spins faster than Planet W on its axis.
 C Planet W has a longer day than Planet V
- (1) A only
 (2) C only
 (3) A and B only
 (4) A, B and C
22. Tom set up the following circuit. W is a 7-cm iron rod. He closed the circuit and observed the brightness of the bulb. He repeated using an iron rod of 10 cm, 15 cm and 20 cm.

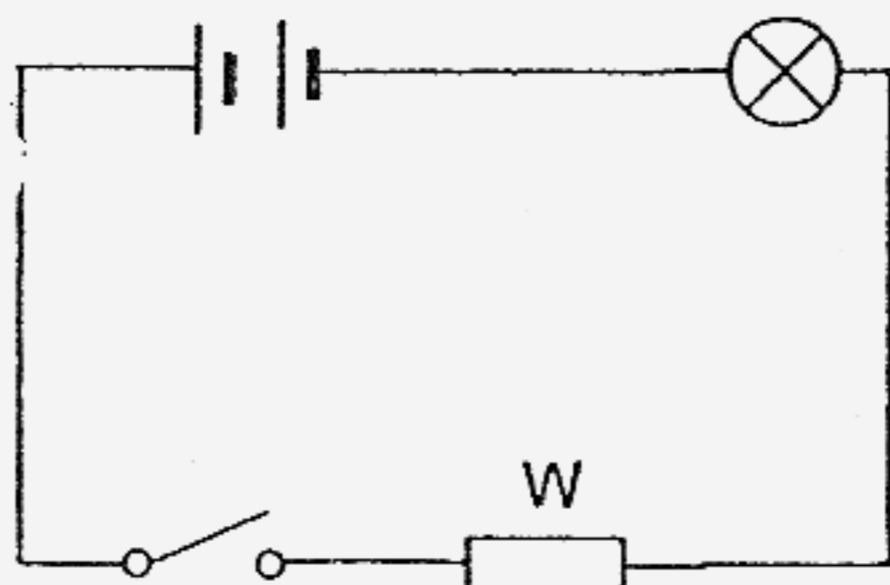

Which one of the following is likely to be Tom's aim of experiment?

- (1) ✗ To find out if the presence of the switch affect the flow of electricity
 (2) ✗ To find out how the number of batteries affect the flow of electricity
 (3) ✓ To find out how the material of the rod affect the brightness of the bulb
 (4) To find out how the length of the rod affects the brightness of the bulb in the circuit

23. The diagram below shows three magnets.

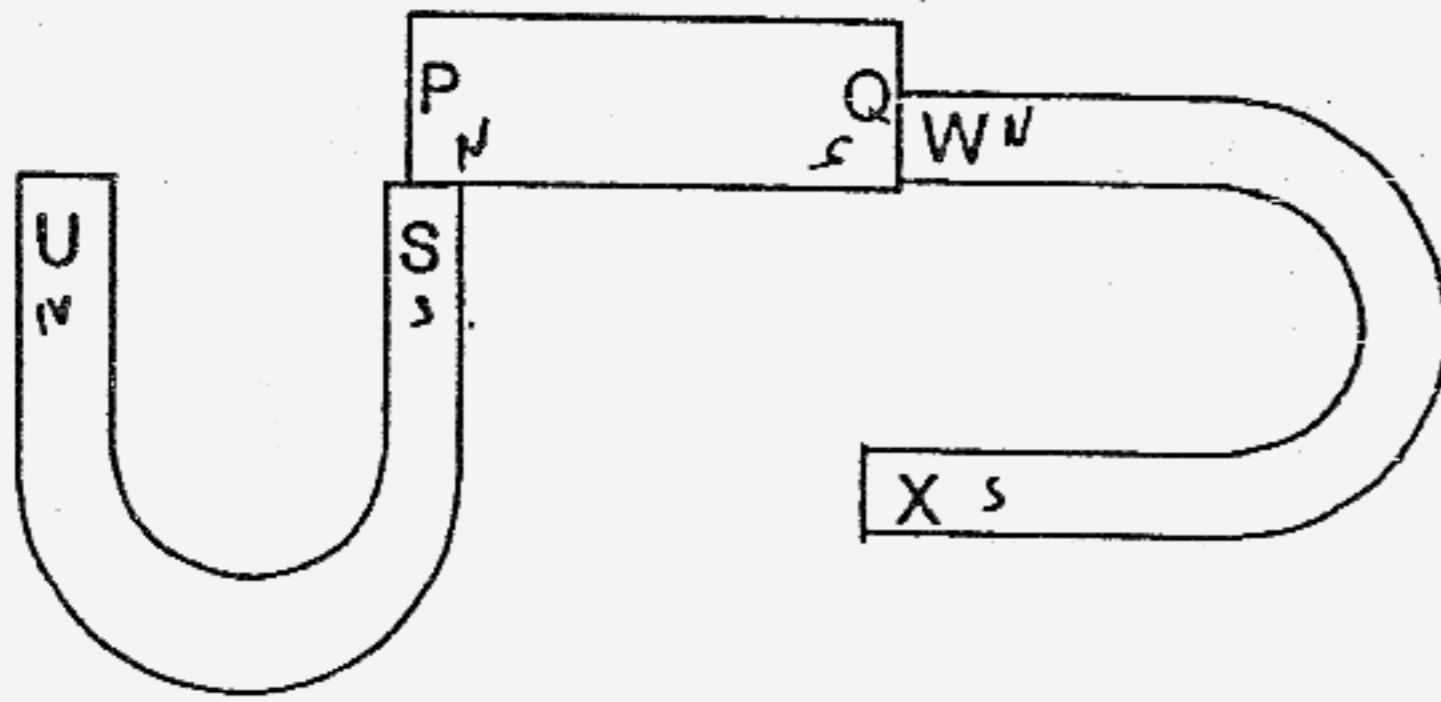

Based on the diagram above, which of the following statements about the poles of the magnets is/are false?

- A S and W are similar poles.
- B X will repel Q and be attracted to P.
- C W will repel P and be attracted to S.

- (1) A only
- (2) B only
- (3) A and C only
- (4) B and C only

24. James carried out an experiment to find out the effort needed to lift a 600N load using four different wheel and axle, A, B, C and D. He recorded his results in the table below.

Wheel and axle	Diameter (cm)		Effort (N)
	Wheel	Axle	
A	20	10	300
B	20	5	150
C	30	30	600
D	30	?	300

Which one of the following diameters of axle when used with a wheel of 30cm in diameter would require an effort of 300g?

- (1) 6 cm
- (2) 8 cm
- (3) 12 cm
- (4) 15 cm

25. Which of the following operate by using a renewable source of energy?

- A windmill
- B solar heater
- C kerosene lamp
- D hydroelectric power station

- (1) A and B only
- (2) B and C only
- (3) A, B and D only
- (4) A, B, C and D

26. The diagram below shows the length of the same spring suspending different loads.

(Diagrams are not drawn to scale)

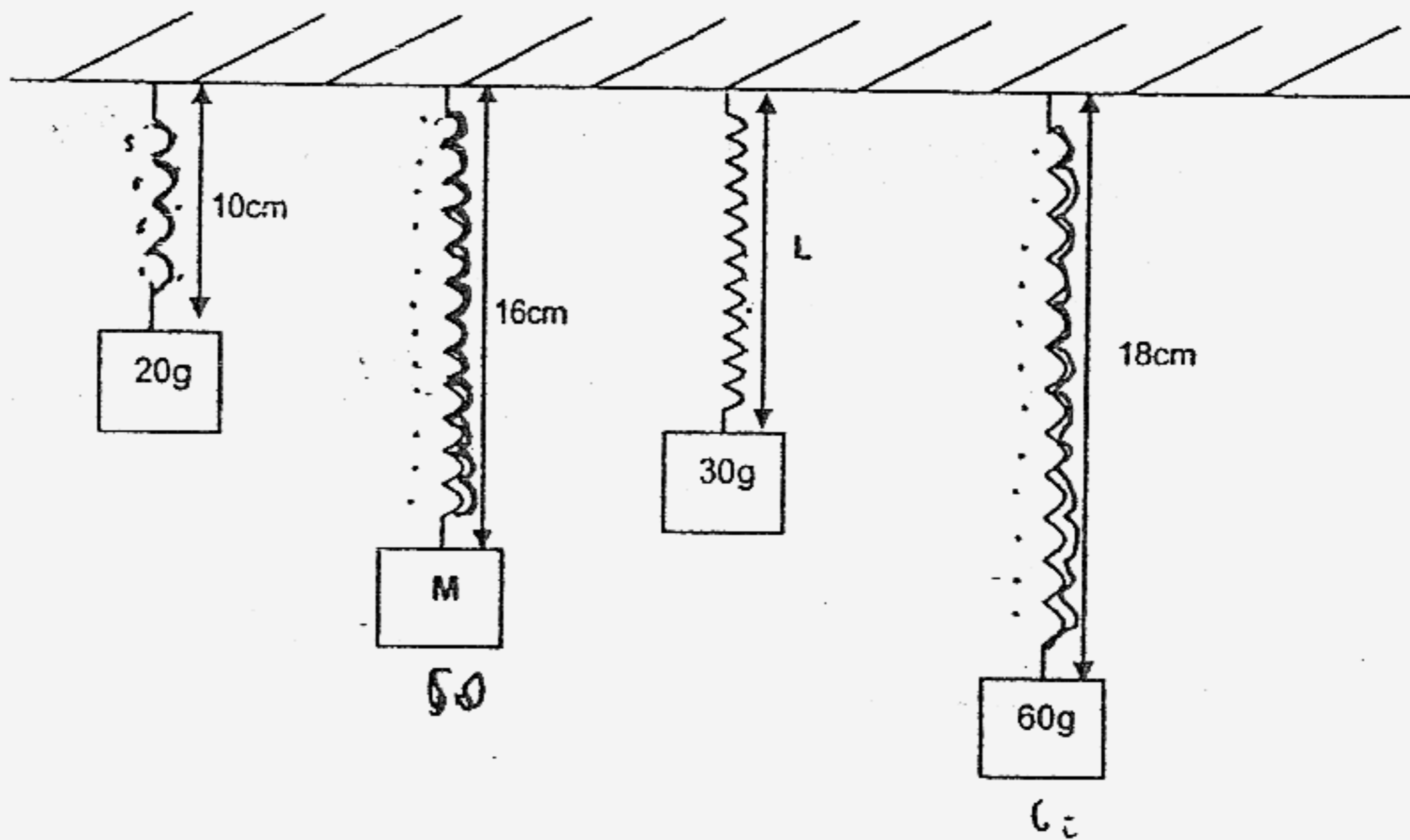

Which one of the following sets of values for "M" and "L" is correct?

	M (g)	L (cm)
(1)	40	12
(2)	40	14
(3)	50	12
(4)	50	14

27. Amy wants to find out the pollution level of five different locations in the school.
 She smeared a layer of oil on five pieces of glass slides and placed them at the five different locations in the school.
 After some time, she collected the slides and checked the amount of dust particles trapped.

To ensure a fair test, which of the following variables must Amy keep the same?

- A size of glass slides
- B amount of oil used
- C duration of experiment
- D location where slides are placed

- (1) A and B only
- (2) C and D only
- (3) A, B and C only
- (4) A, B, C and D

28. The diagram below shows the shadow cast by a pole.

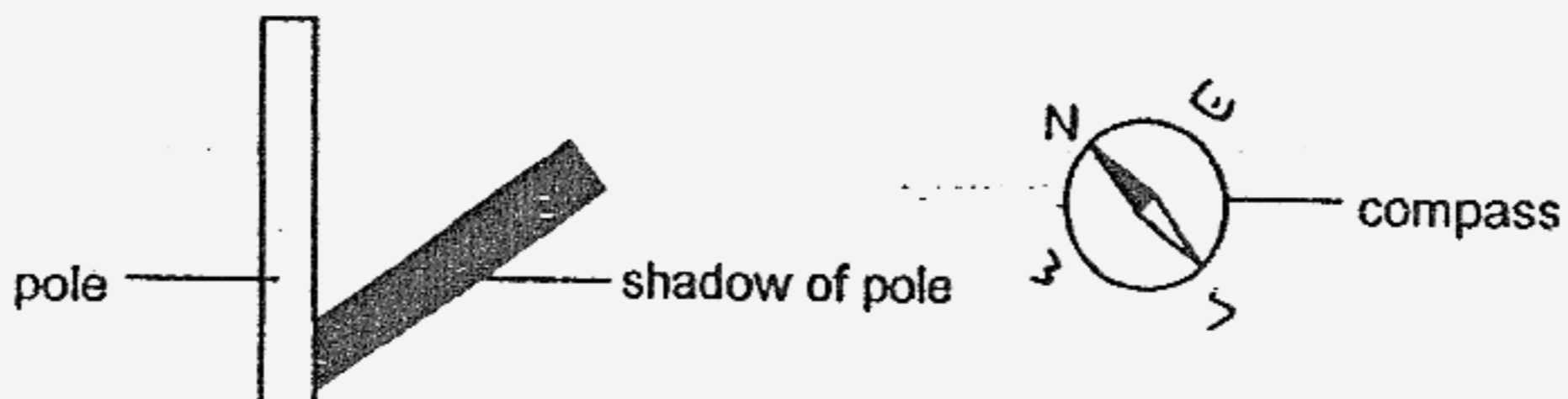

At what time of the day is the shadow likely to be formed?

- (1) 7 am
- (2) 11 am
- (3) 2 pm
- (4) 5 pm

29. Sally set up an experiment as shown below in the laboratory.

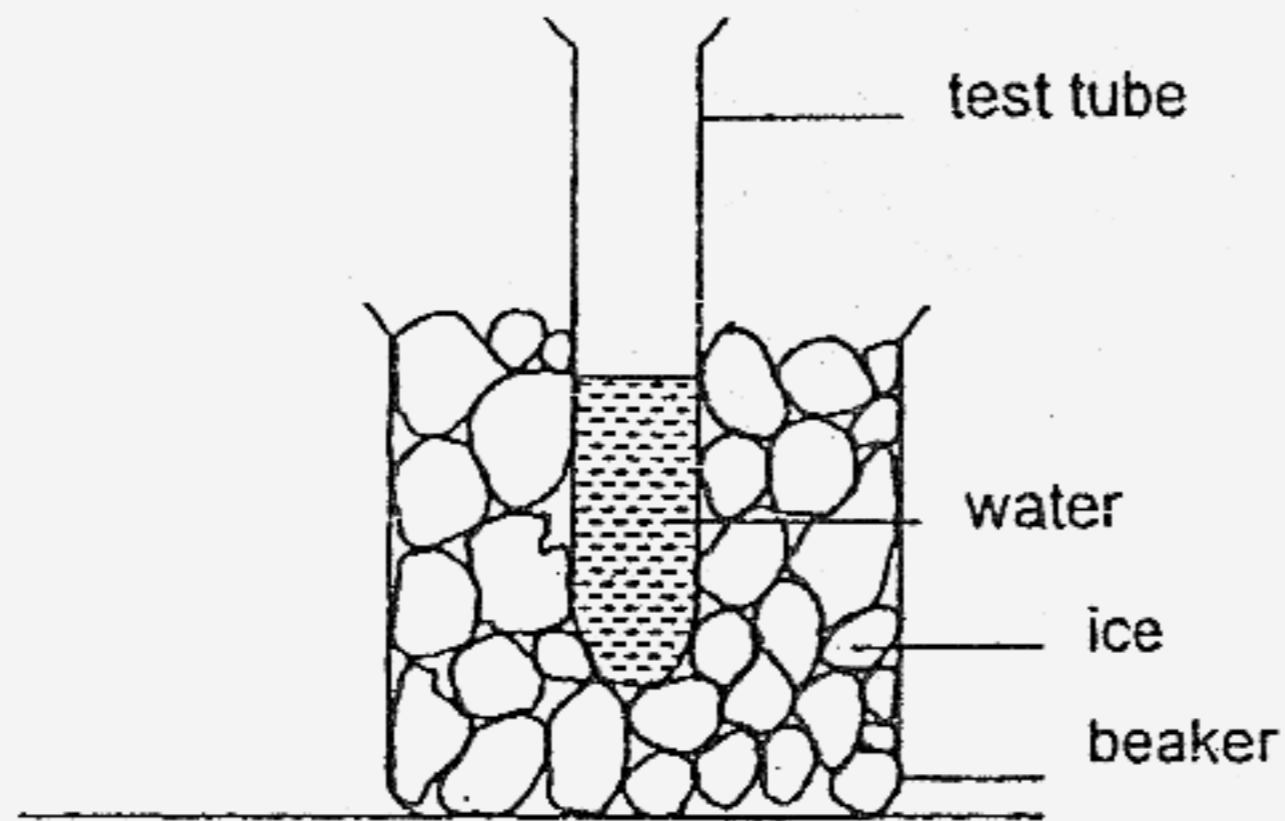

After ten minutes, which of the following are likely to have changed?

- A State of ice in the beaker
- B State of water in the test tube
- C Temperature of ice in beaker
- D Temperature of water in the test tube

- (1) A and D only
- (2) B and C only
- (3) A, C and D only
- (4) A, B, C and D

30. A ball at position H on a table is set in motion as shown below. It rolls to position I, down from the table and lands at position J on the floor. It then continues to roll till it comes to a stop at position K, as shown in the diagram.

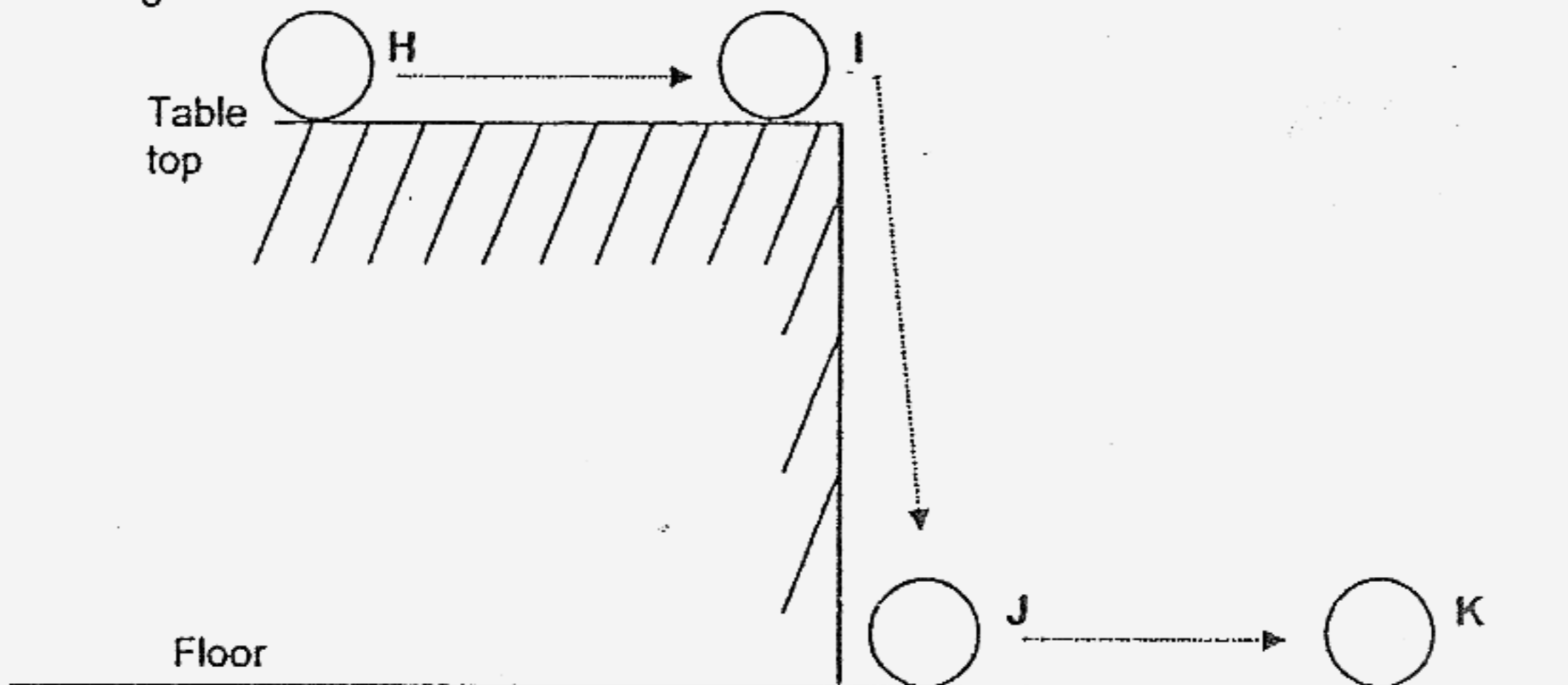

Which of the following conclusions are correct based on the diagram above?

- A The ball gains kinetic energy between J and K.
- B The ball has kinetic energy and potential energy at I.
- C The potential energy of the ball decreases from I to J.

- (1) A and B only
- (2) A and C only
- (3) B and C only
- (4) A, B and C



HENRY PARK PRIMARY SCHOOL

2007

SCIENCE

PRIMARY 6

BOOKLET B

Name: _____ ()

Class: Primary 6 _____

**16 Questions
40 Marks**

Total Time for Booklets A and B: 1 h 45 min

DO NOT OPEN THIS BOOKLET UNTIL YOU ARE TOLD TO DO SO.

READ AND FOLLOW INSTRUCTIONS CAREFULLY.

Write your answers to questions 31 to 46 in the spaces given.

- 31 The diagram below shows a young plant growing from a bean seed.
 (a) Name the parts of the seedling marked A and B in the boxes provided. [1]

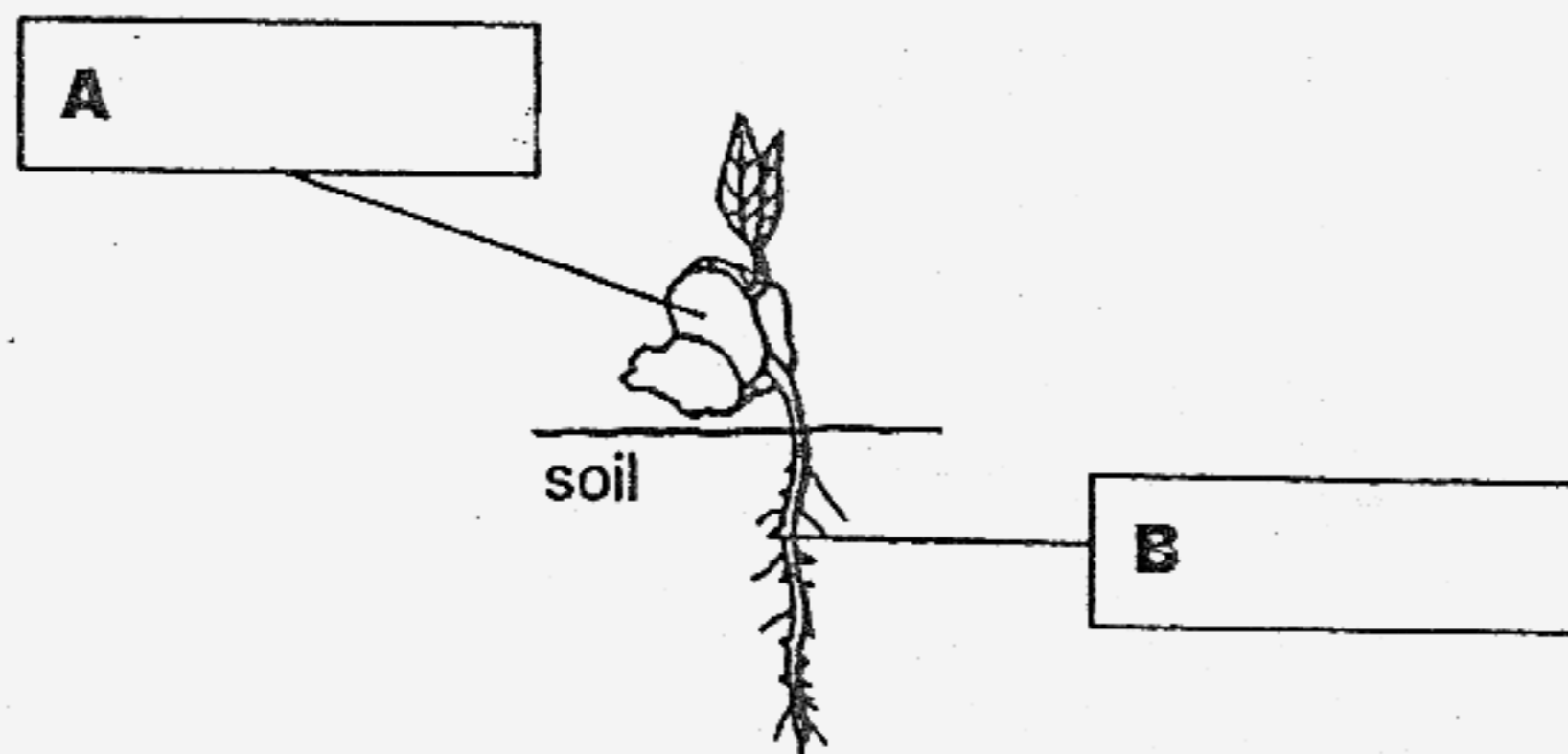

- (b) What is the function of the part marked A ? [1]

- 32 The classification chart shows how some animals are grouped .

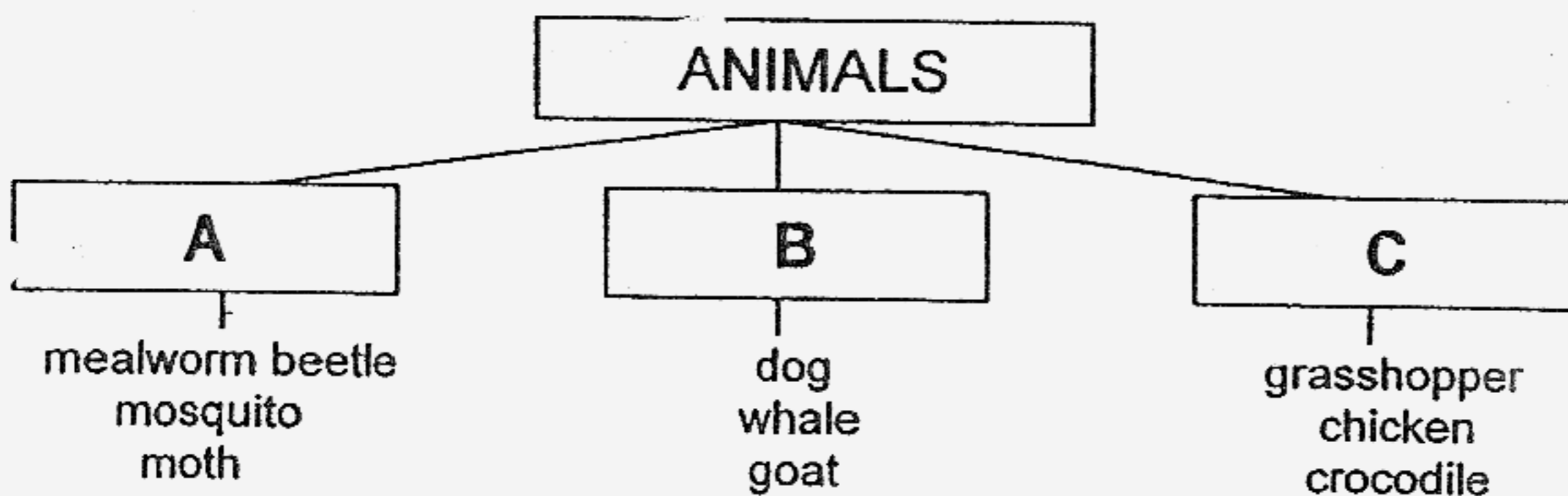

- a) How is the method of reproduction of the animals in Group A and C different from B ? [2]

- b) Under which heading will you put "cockroach" ? [1]

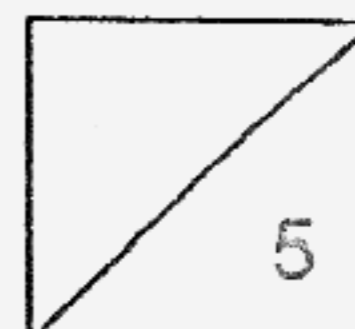

33 The diagram shows a bottle garden.

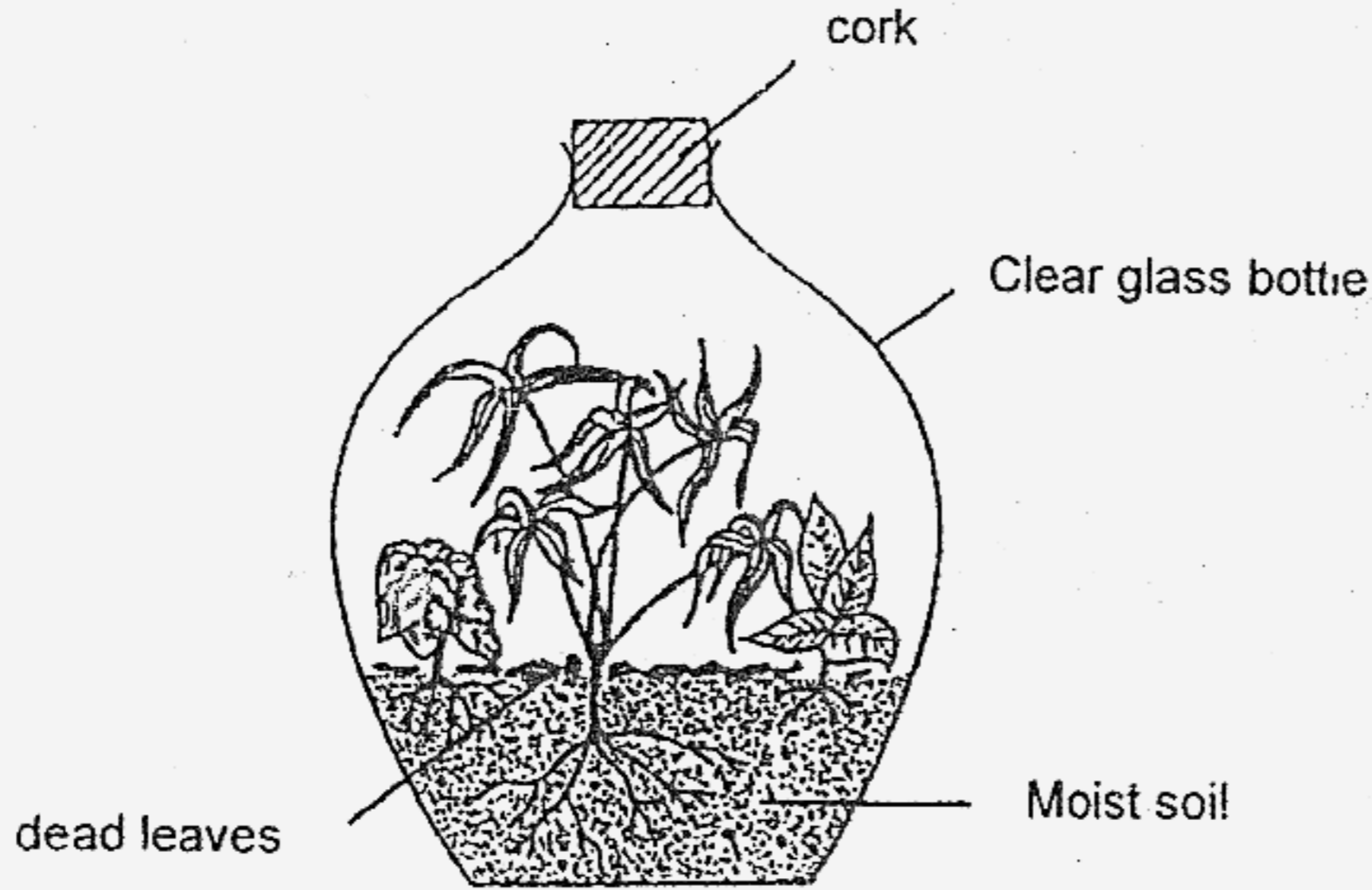

(a) The plants in the bottle do not require fertilizer and yet, with little attention, they can remain healthy for a few years.

Explain why this is so. [1]

(b) Suggest a possible reason why the bottle garden should **not** be put in a place where it is exposed to direct sunlight. [1]

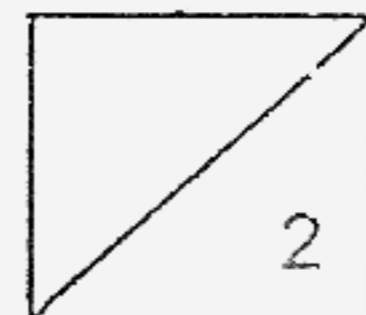

34 Jack was asked to classify 8 objects into a classification chart . First he classified the 8 objects into two groups of 4 each. Then he further classified each group into two smaller groups of 2 objects each.

(a) Complete Jack's chart by drawing in the rest of the missing objects. [2]

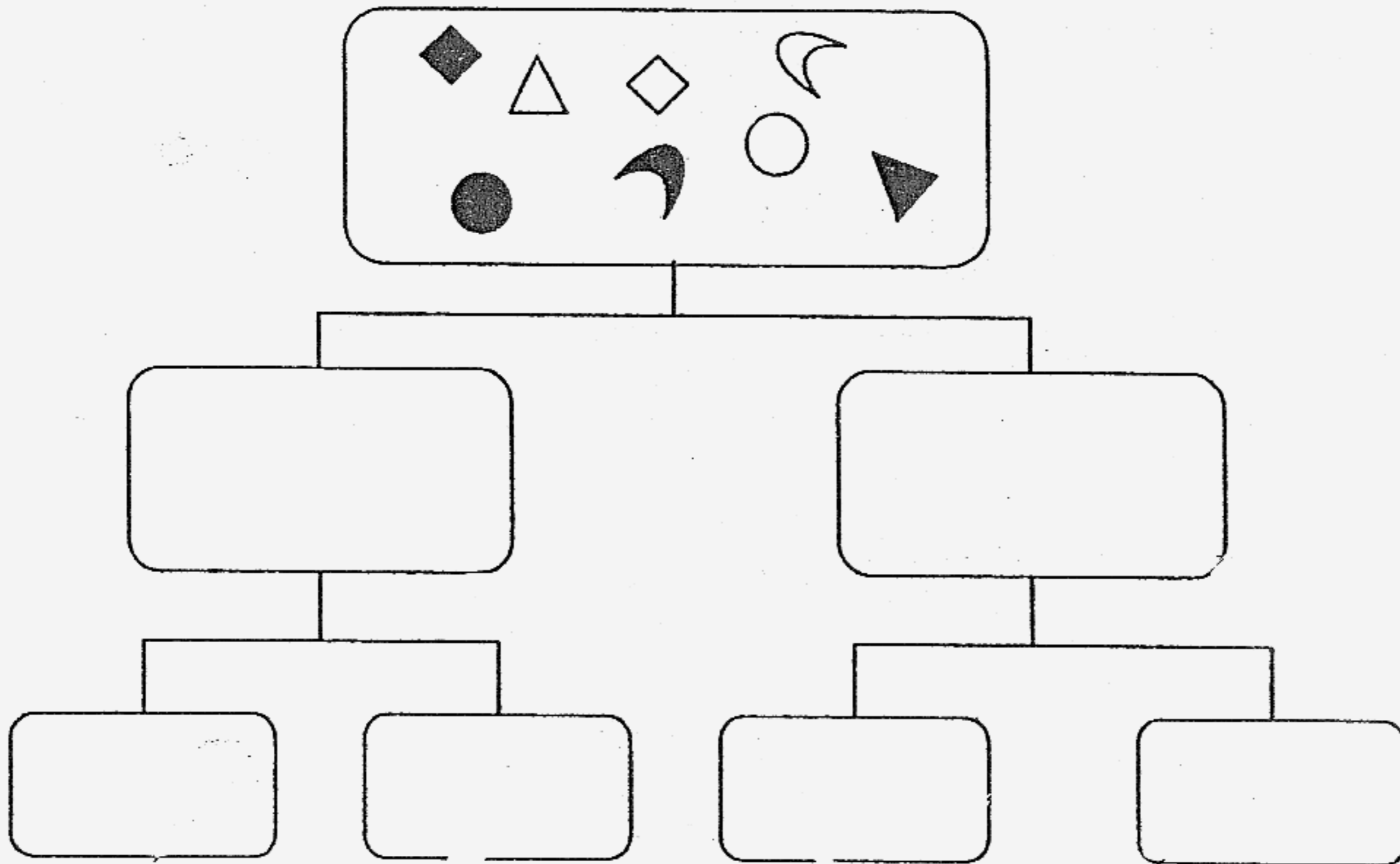

(b) State the property that you have used to classify the objects into the last four boxes. [1]

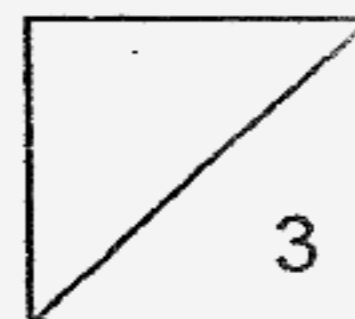

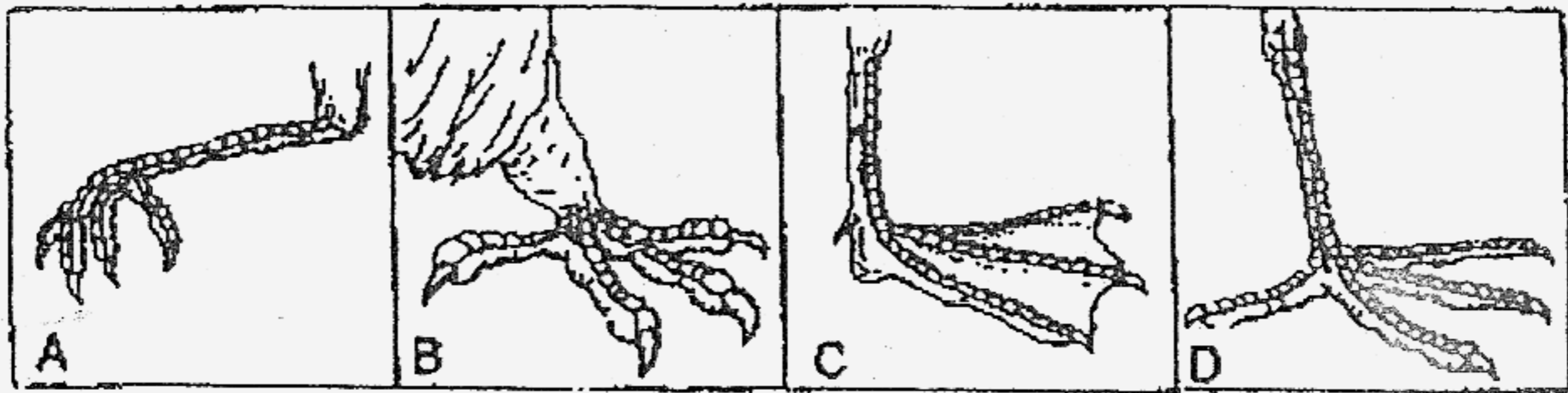

(a) The diagrams above shows the feet of a group of animals. Which group of animals do they belong to? [1]

(b) The diagram below shows the foot of Animal X. Which one of the above feet : A, B, C or D belongs to an animal that can move in the same way as Animal X? [1]



(b) _____

(c) Which part of the feet enables both animals (X and the animal you have named in (b)) to move in this way? [1]

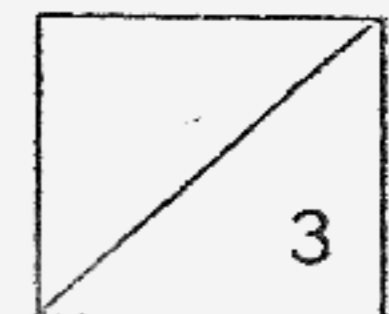

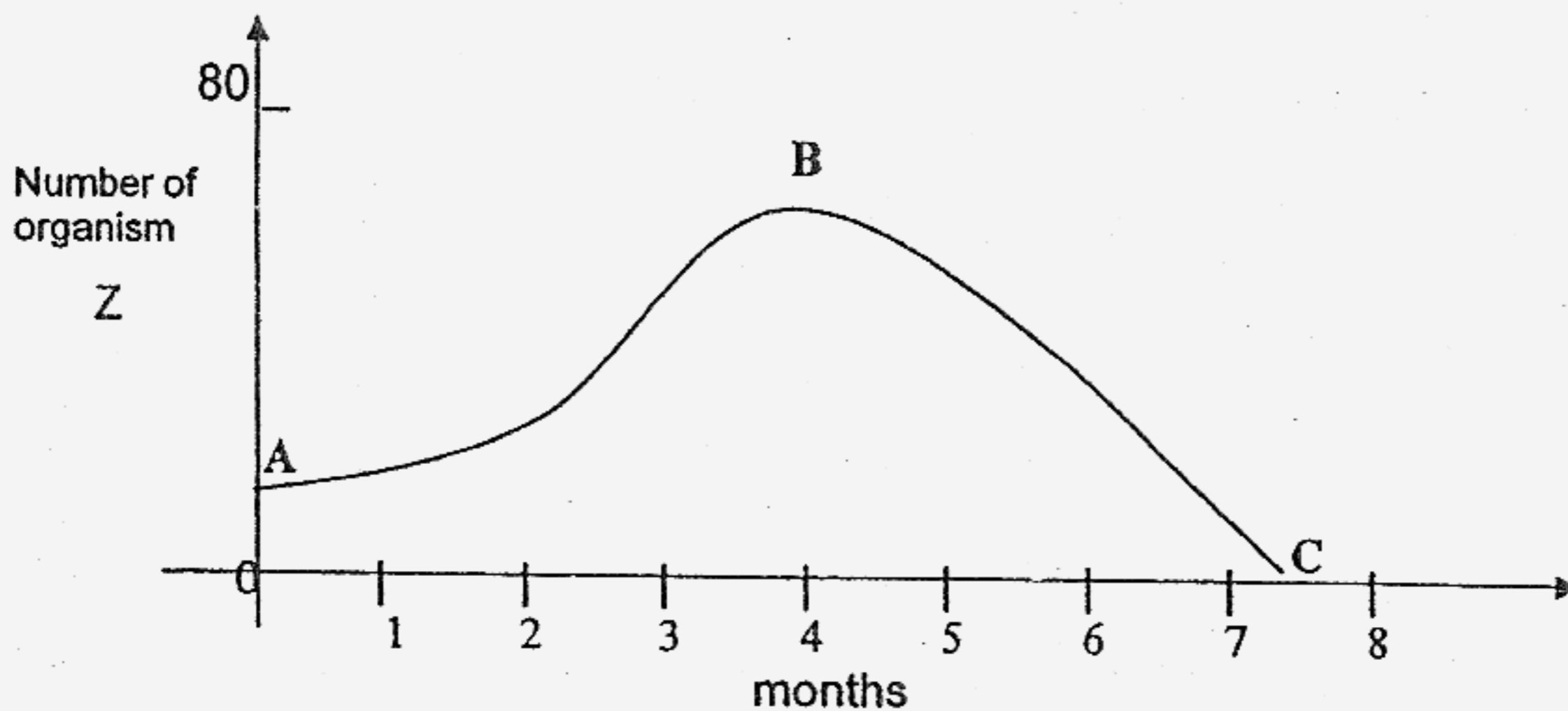

The above graph shows the population of Organism Z over a period of 7 ½ months.

(a) Describe what happens to the population of Organism Z in the first four months. [1]

(b) List two possible reasons for the fall in the number of Organism Z from B to C. [2]

Reason 1: _____

Reason 2: _____

37 The diagram below shows a brinjal plant.

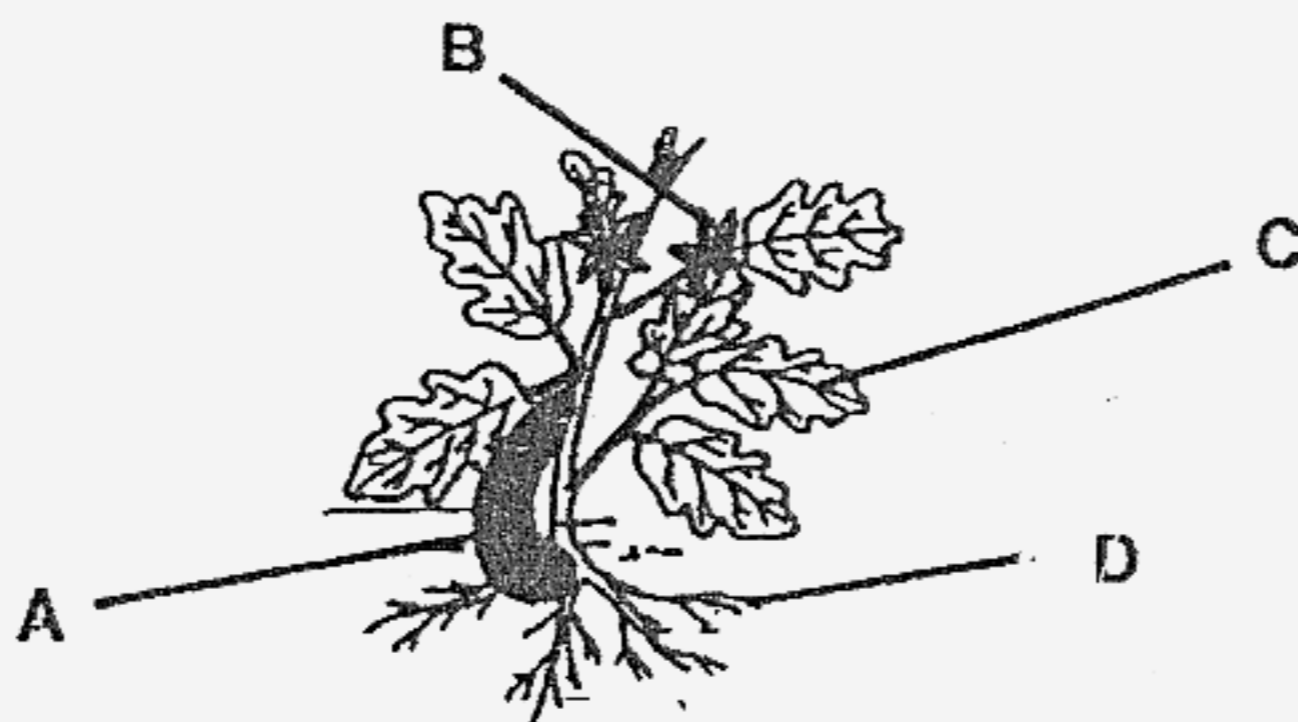

a) Which part of the plant will enable it to ensure the survival of its kind? Give a reason for your answer. [1]

b) State and explain what may happen to the plant if half of the leaves are eaten by caterpillars? [1]

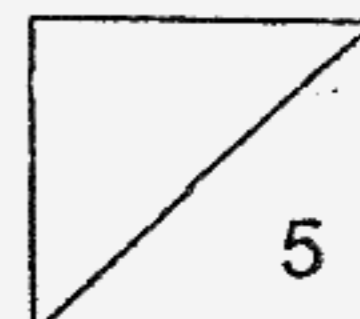

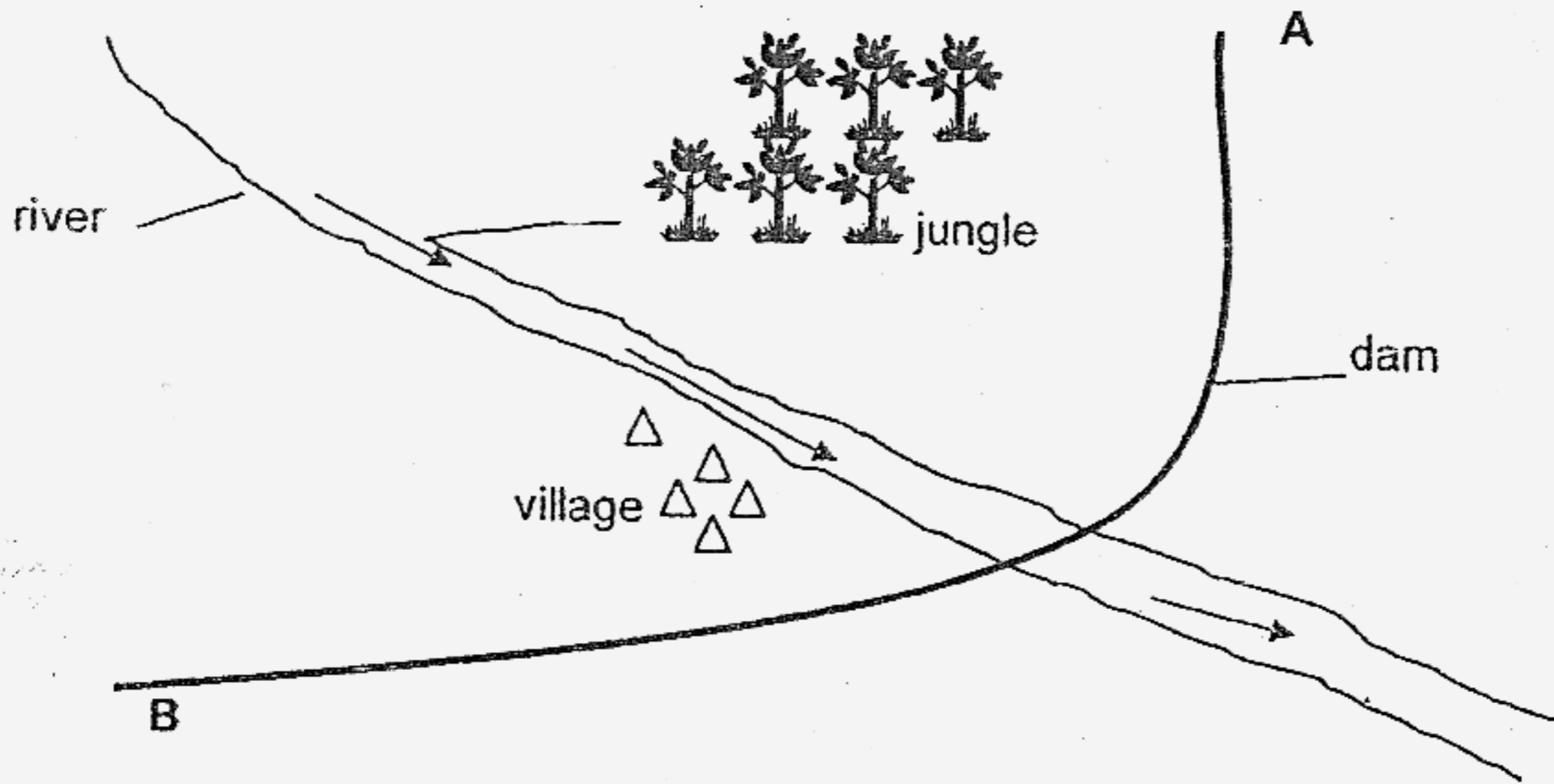

The diagram above shows a river flowing between a village and a jungle. When a dam is built across the river at **AB**, the flow of the river water is blocked.

(a) Give one negative impact of building the dam has on the environment. [1]

(b) Give one advantage of building the dam. [1]

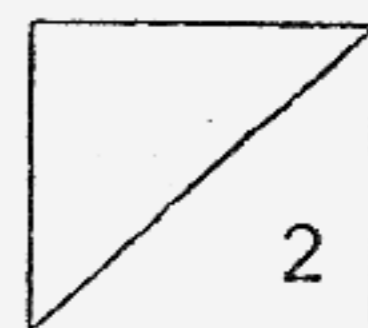

39. The diagram below shows a 500 cm³ flask which contains 150 cm³ of water and a syringe which contains 80 cm³ of air. When the syringe is pushed all the way down, all the air in it entered the jar.

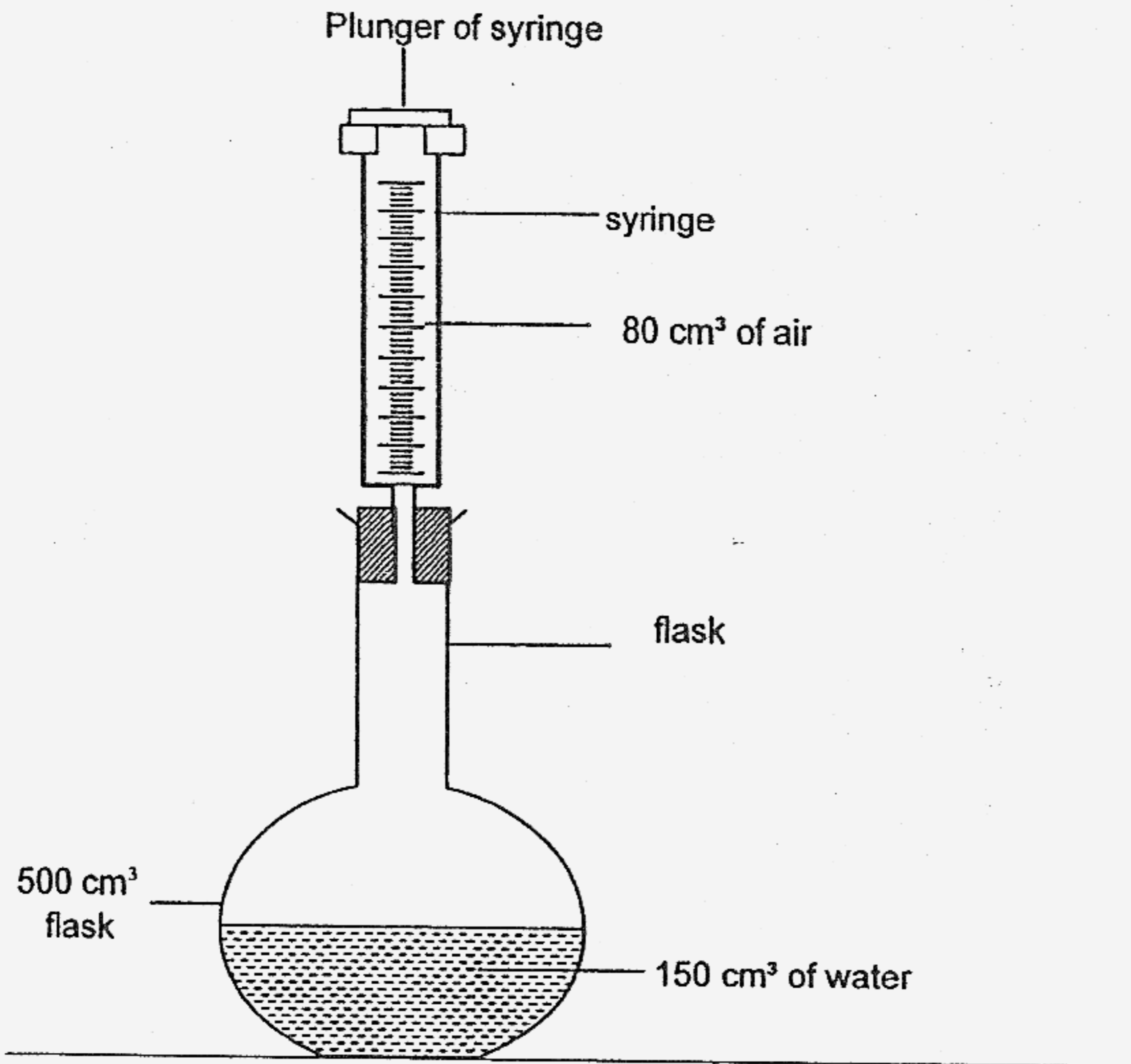

(a) What is the final volume of air in the flask when the syringe is pushed all the way down twice? [1]

(b) From the experiment and results in (a), list the property of air shown. [1]

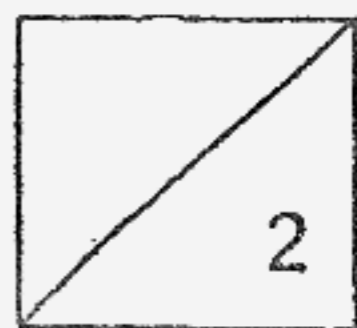

40. Susan breathed into a mirror and noticed a "mist" forming on the surface of the mirror.

(a) Explain how the "mist" is formed. [2]

(b) As Susan continues to breathe repeatedly onto the mirror, Susan observed that the "mist" could no longer be formed. Explain her observation. [1]

41. Jimmy wants to find out the volume of the hole as shown in the diagram below.



He is given a beaker of water and a measuring cylinder only. List four steps he should take in order to determine the volume of the hole above. [2]

Step	What Jimmy should do:
1	
2	
3	
4	

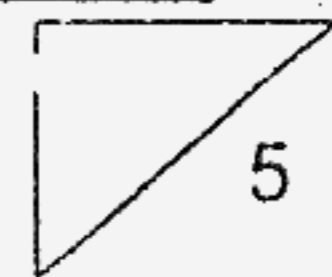

Circuit A

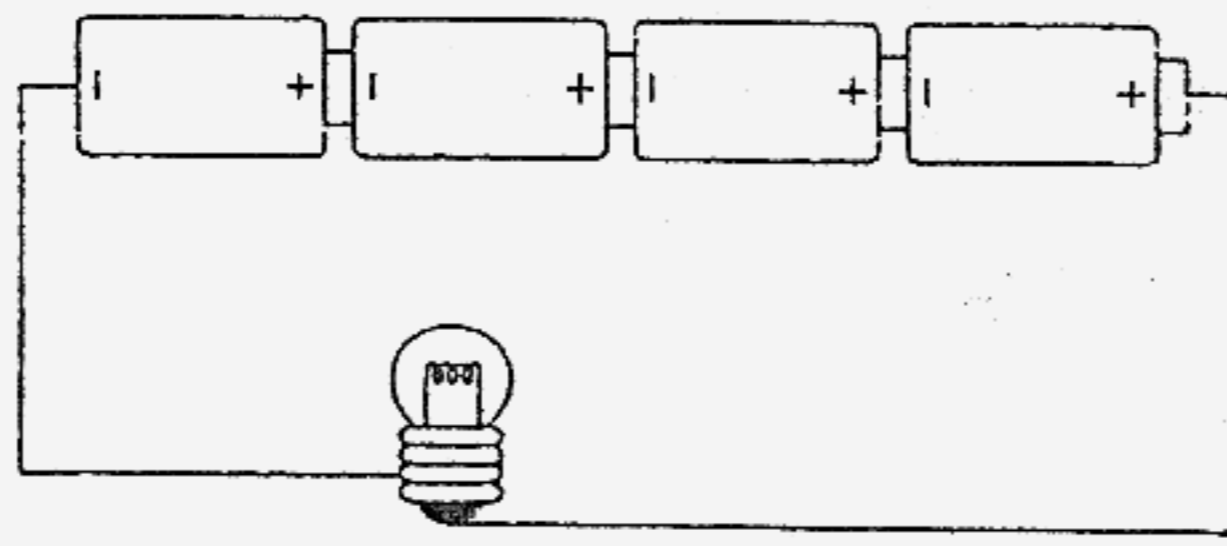

Circuit B

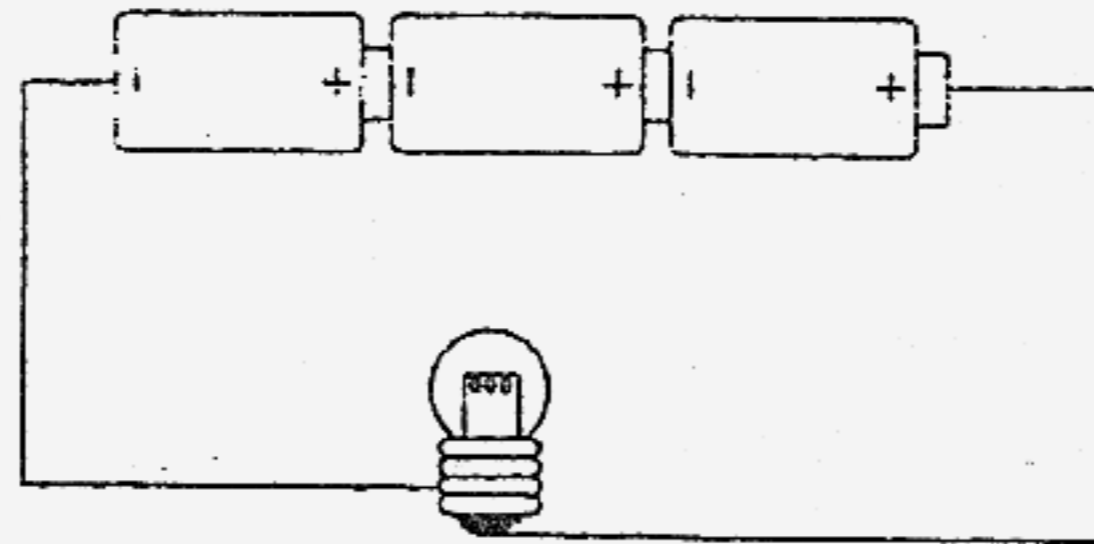

Circuit C

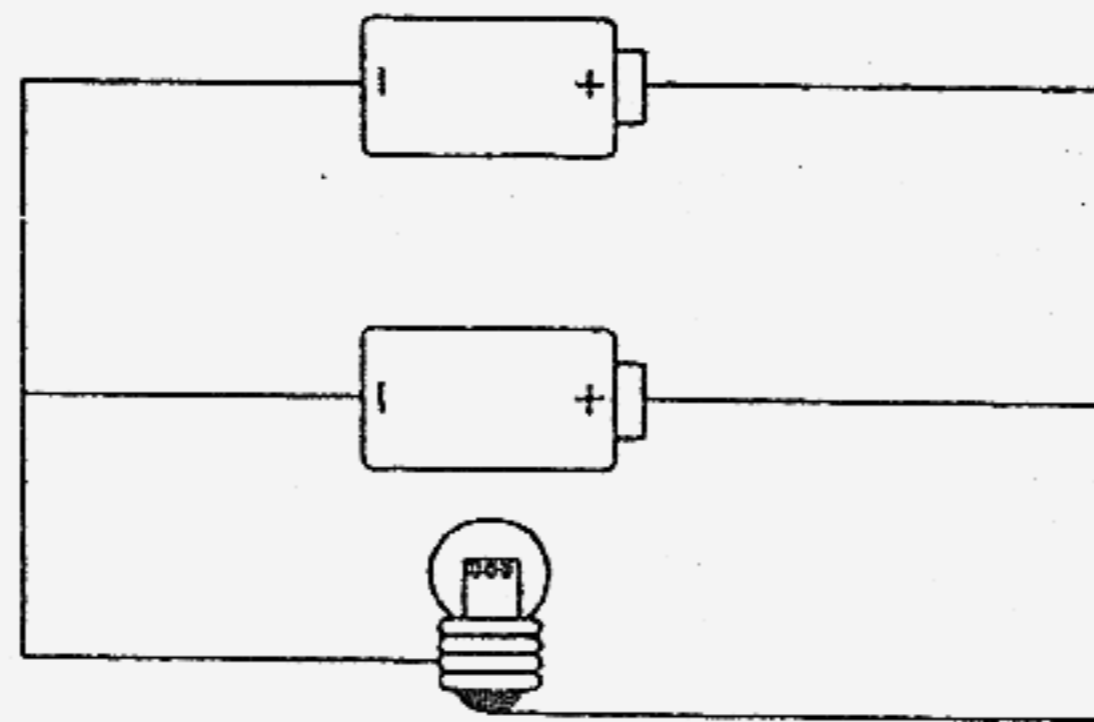

Circuit D

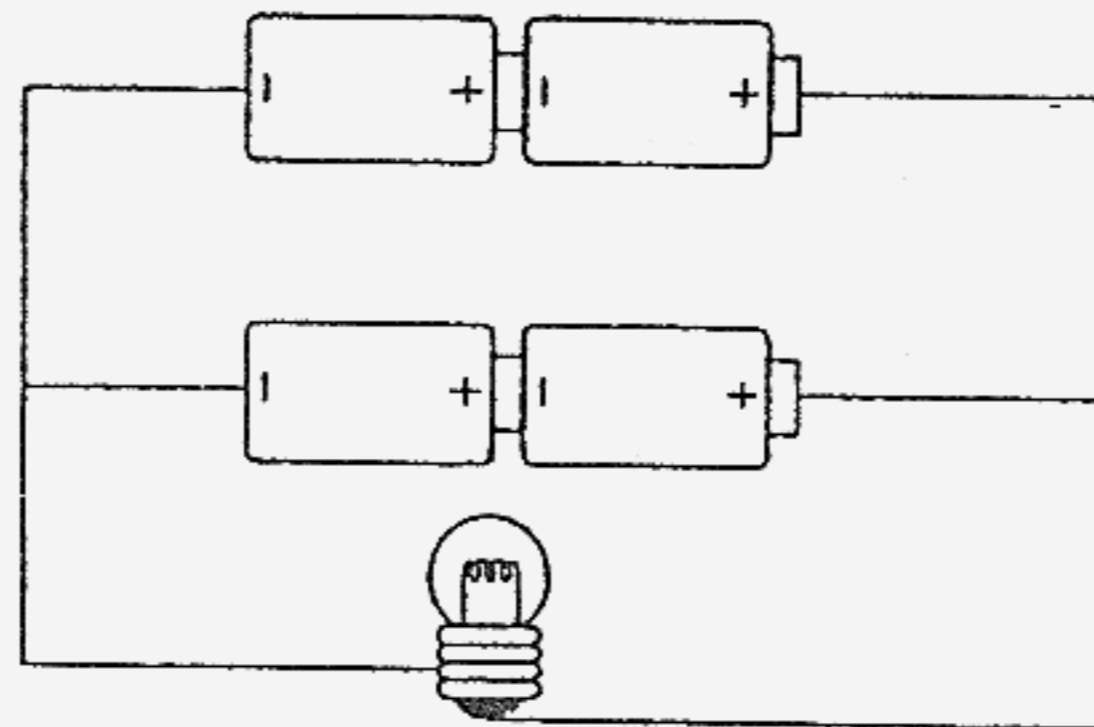

Similar bulbs and batteries were used.

When the circuits were connected, each of the bulb in the circuit lit up.

Arrange the circuits, A, B, C and D, in ascending order (from the dimmest to the brightest) of the brightness of the bulbs.

[1]

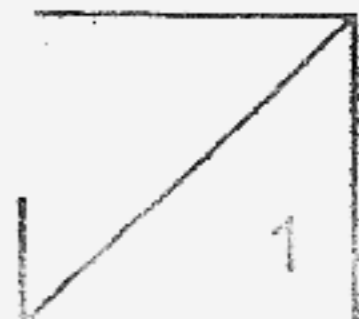

42(b) The diagram below shows four bulbs, K, L, M and N connected to two batteries.

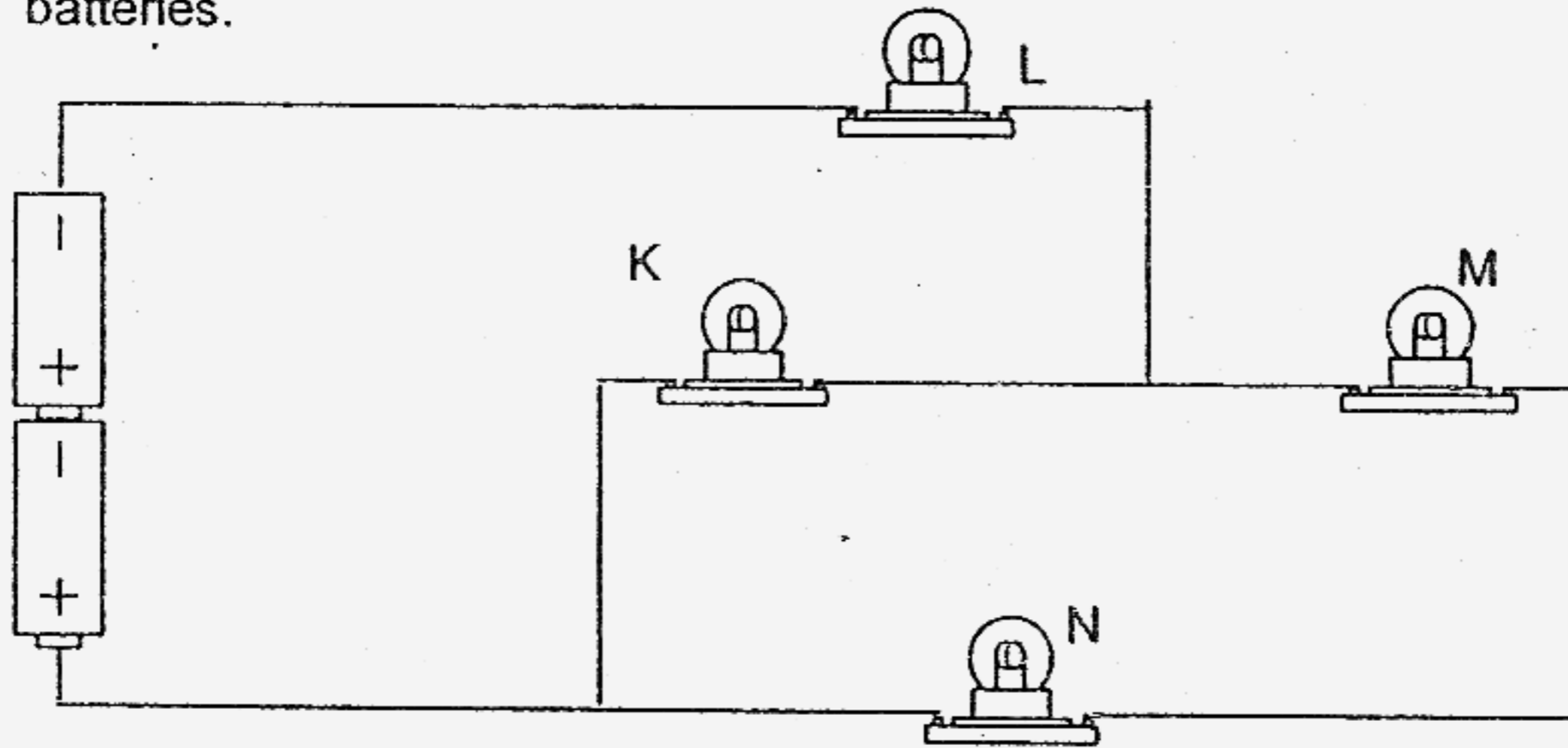

Identify the remaining bulbs which stay lit when one other bulb blows. [2]

Bulb which blows	Bulb(s) which remain lit
K	
L	
M	
N	

43. When four metal bars A, B, C and D, were hung from a piece of rod, they moved in different directions as shown in the diagram below.

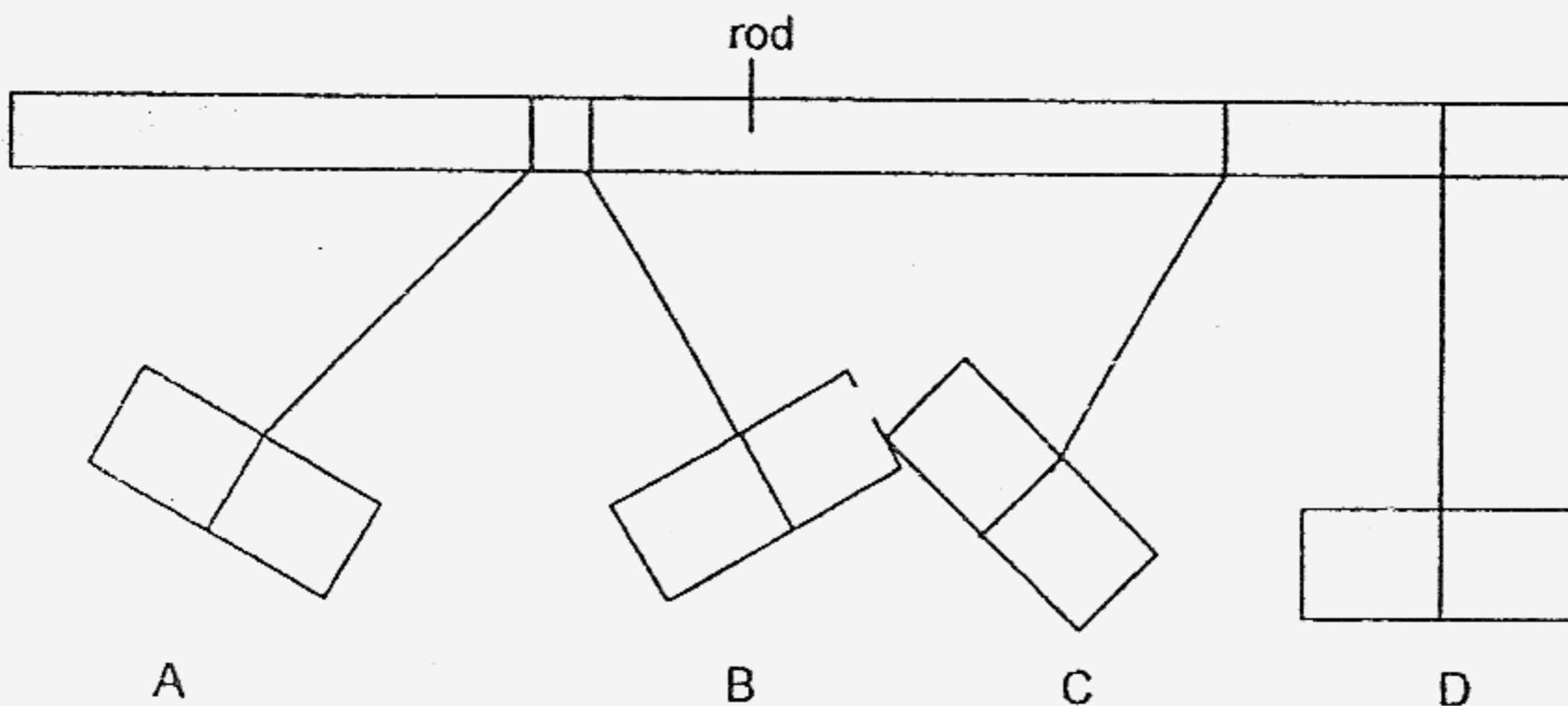

(a) If two of the metal bars are magnets, which two metal bars (A, B, C, D) are most likely to be magnets? [1]

(b) Give a reason for your answer in (a). [1]

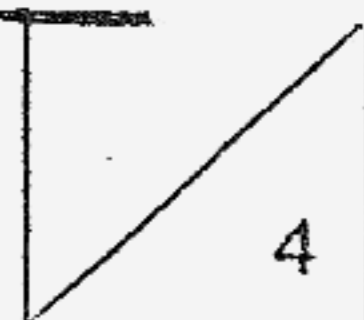

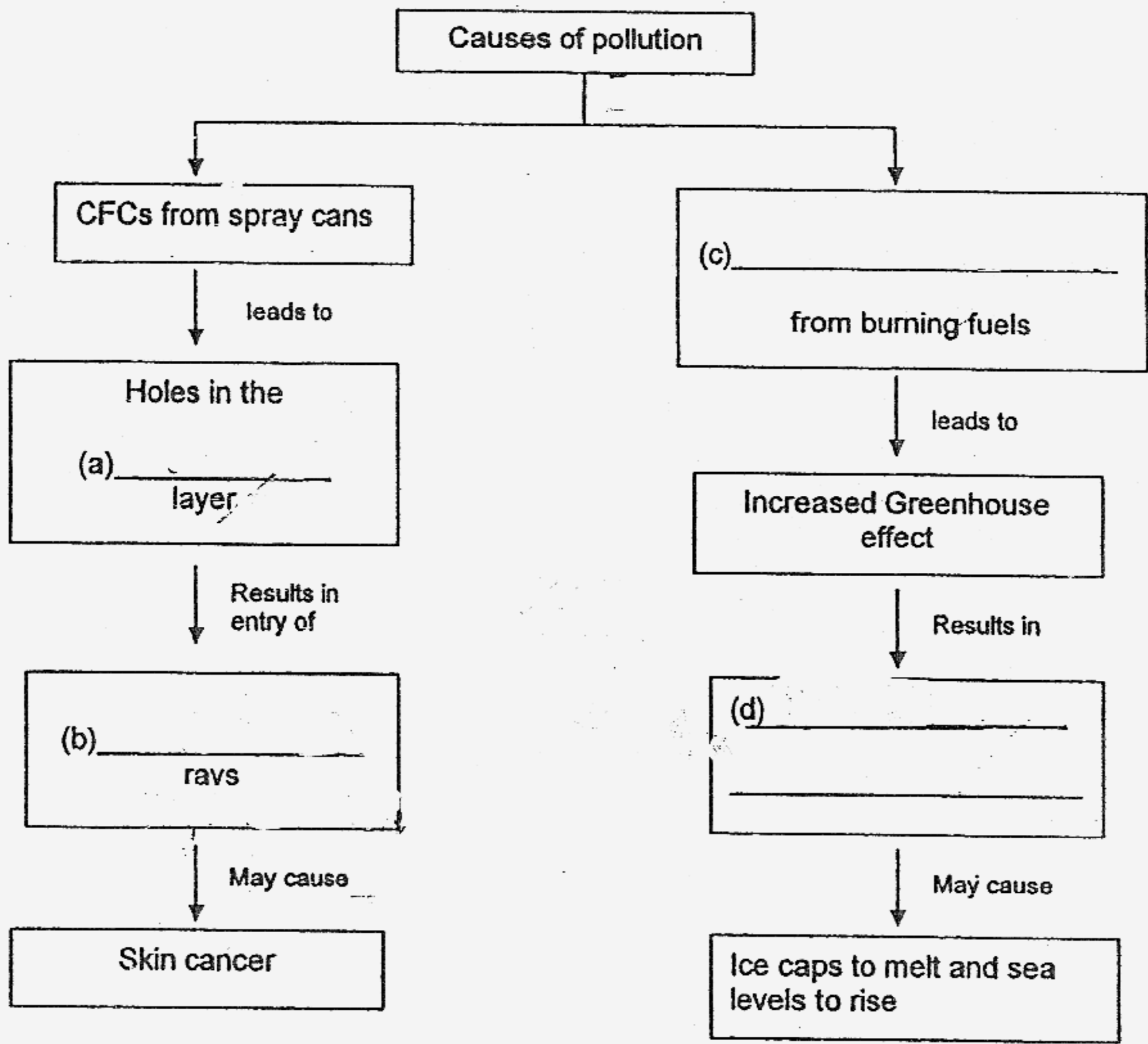

45(a) Tom placed four drops of wax at the four corners of a square metal frame as shown in the diagram below.

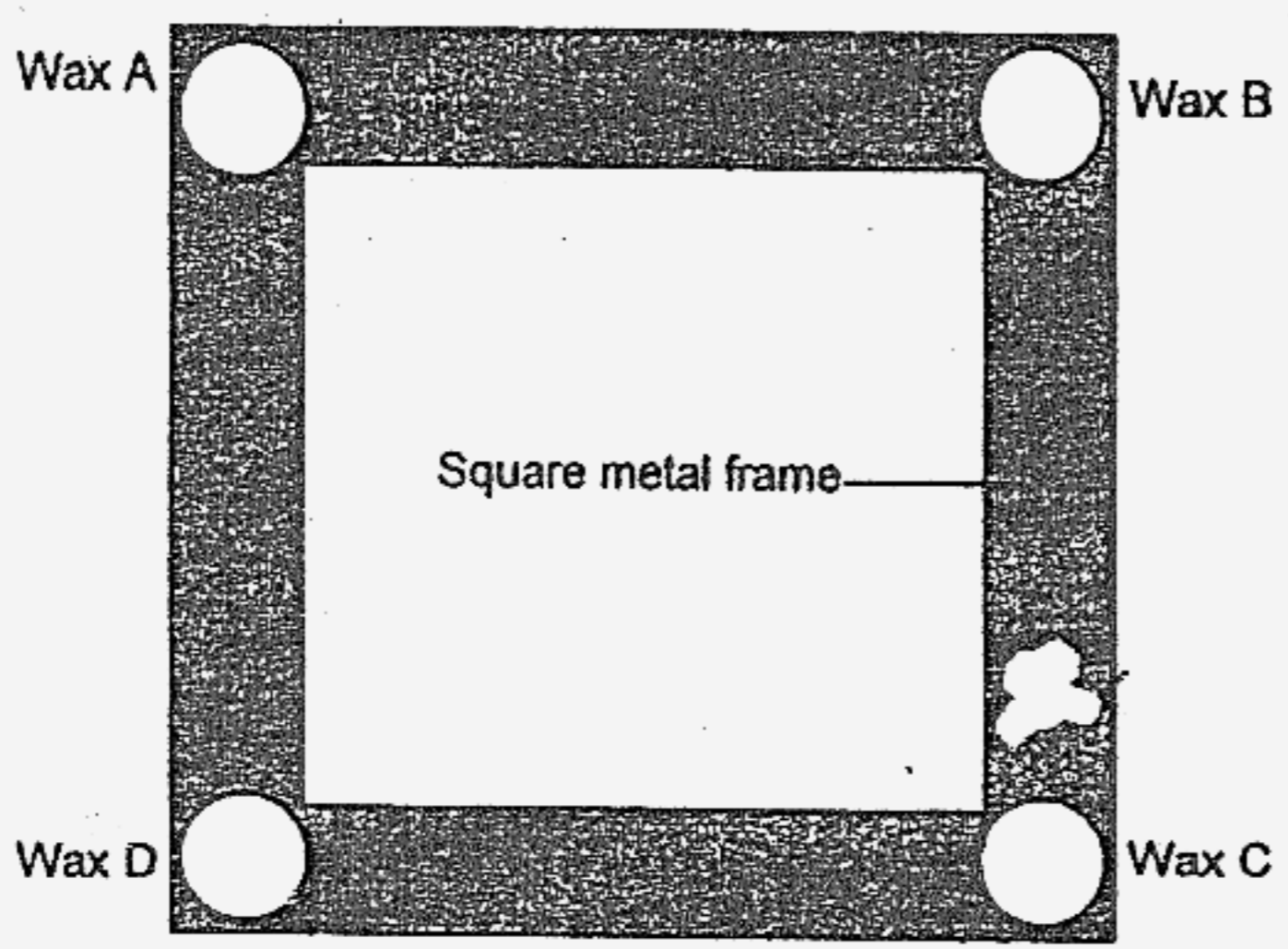

When Tom heated the square metal frame with a bunsen burner, the drops of wax melted in the following order: C, B, D, A.

On the diagram, mark "X" on the spot where Tom is likely to have heated the metal frame. [1]

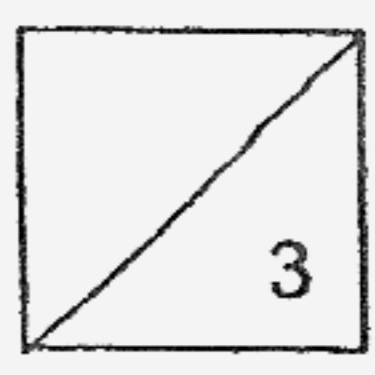

45(b) The graph below shows the temperature changes of a substance Q when it is heated.

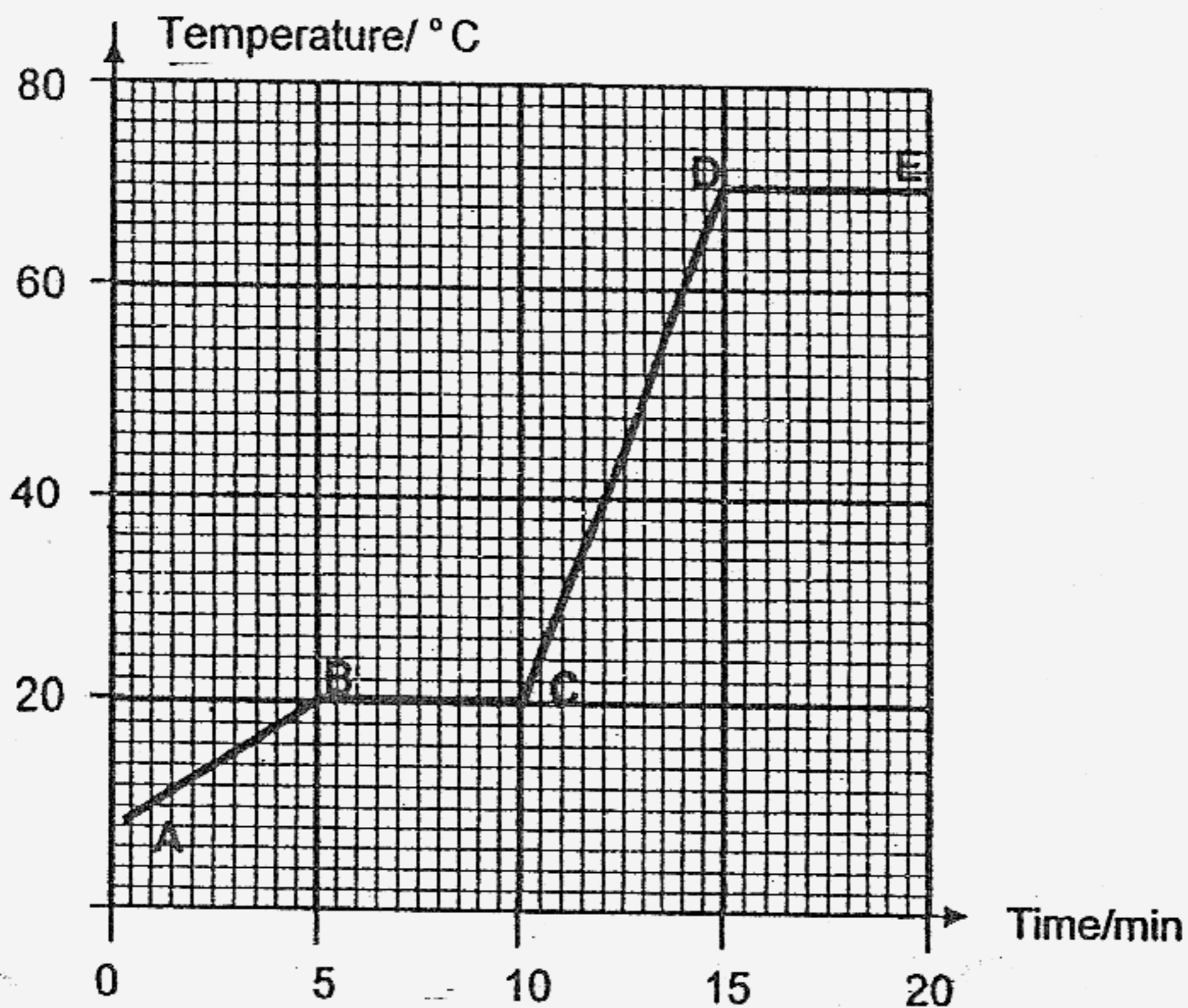

(i) Which part(s) of the graph, AB, BC, CD, DE represent(s) a change in the state of substance Q? [1]

(ii) What is the state of substance Q at 40° C? [1]

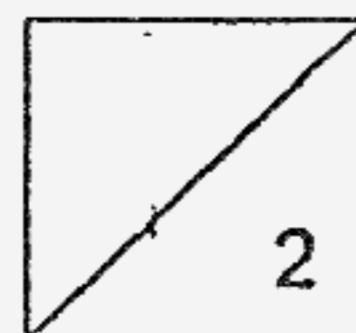

46(a) The diagram below shows the shapes of the shadows produced when two different objects were placed between a screen and a torchlight. The dimensions of the objects are shown the box on the right.

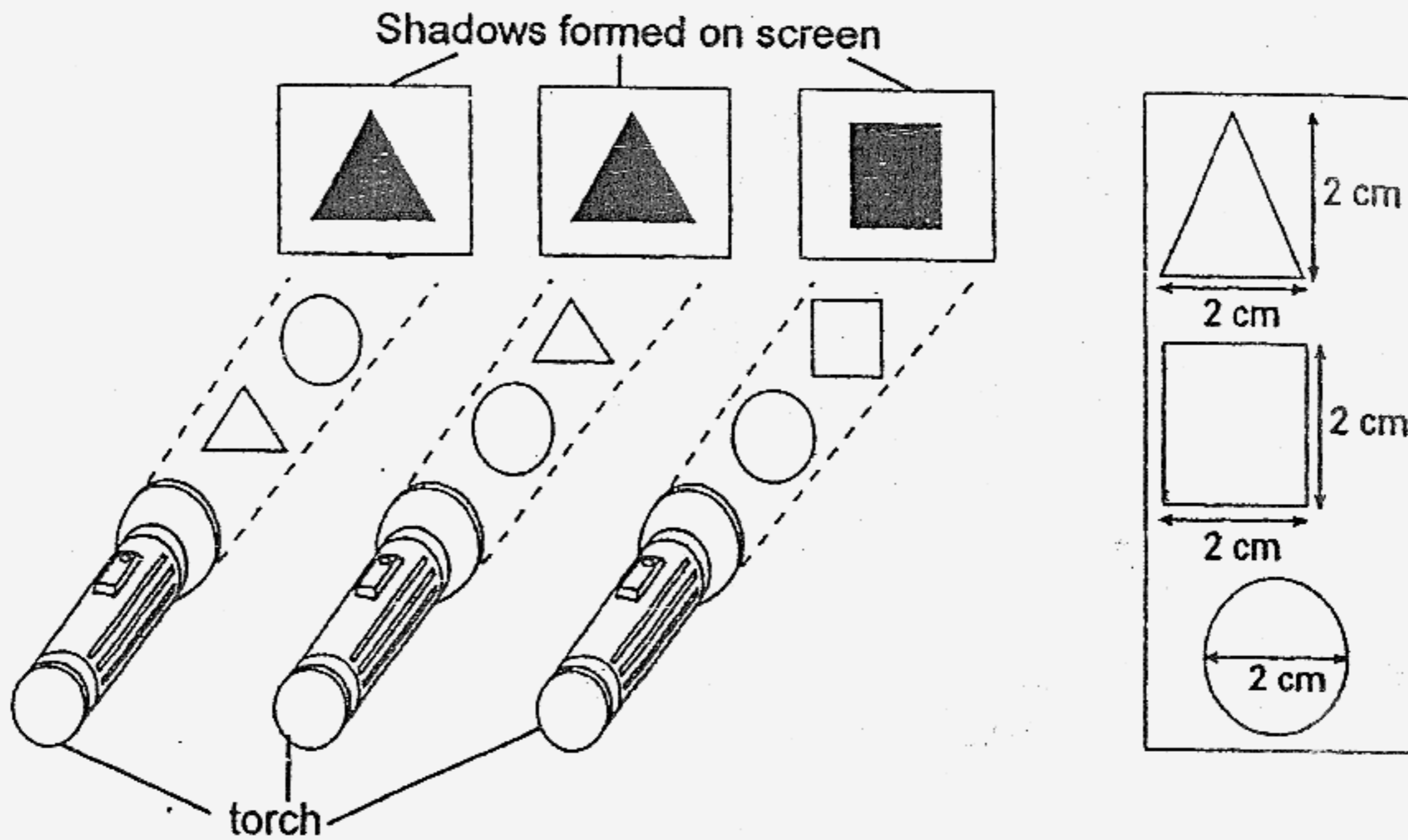

A hole was made in the centre of the square object and it was then placed in front of the screen together with the triangular object, as shown below.

Draw the shadow produced on the screen when the torch is switched on. [1]

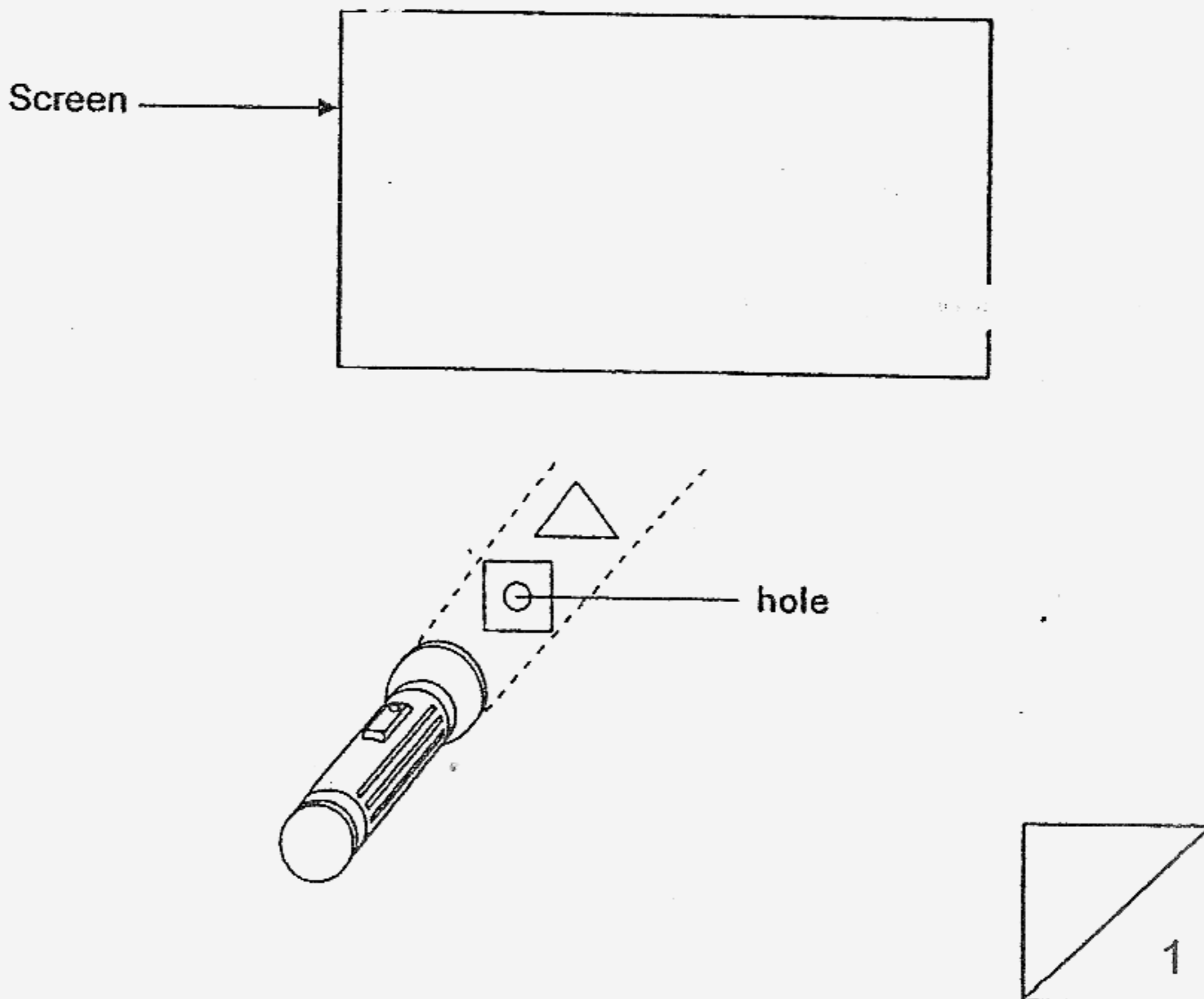

(b) Study the diagram below.

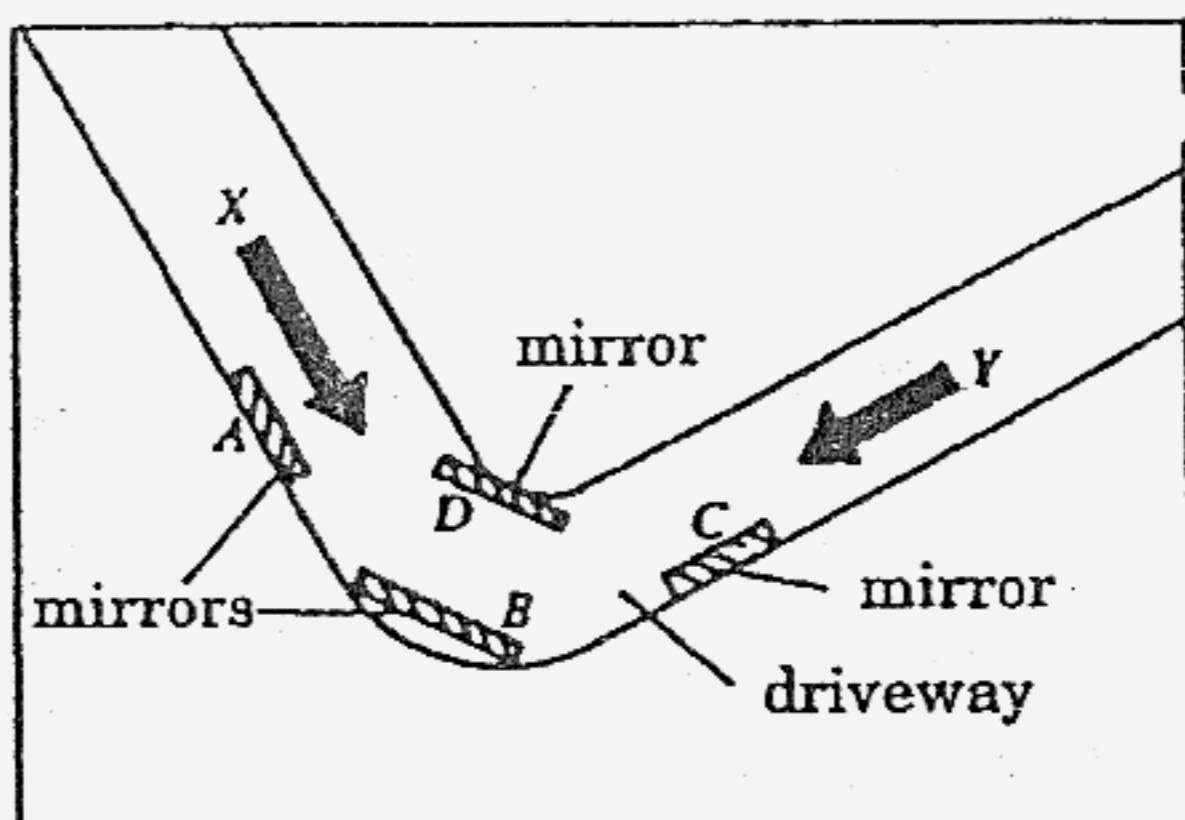

(i) Identify the mirror(s) (A, B, C, D) which enable(s) the drivers at X and Y to see each other. [1]

(ii) State two properties of light which enable drivers at X and Y to see each other. [1]

1. _____
2. _____

-END OF PAPER-

Setters: Mrs J F Siregar
Mrs Seow Jian Jian

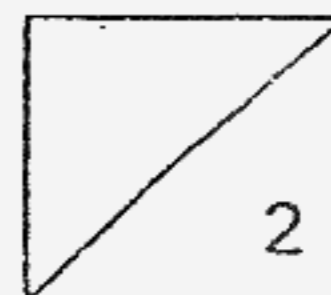

- 1)3 2)3 3)4 4)1 5)1 6)2
- 7)4 8)3 9)2 10)2 11)3 12)1
- 13)2 14)2 15)2 16)3 17)1 18)2
- 19)3 20)2 21)1 22)4 23)1 24)4
- 25)3 26)3 27)3 28)4 29)1 30)3

31)a. Seed leaves b.roots b)It is to give the seeding food until it grow its first leaf.

32)a. The animal in Group A and C lay eggs while the animals in Group B give birth to young. 32)b. C.

33)a. The dead leaves are broken down by decompose into simple substance which are absorbed as nutrients by the plant.

33)b. The glass bottle will trap heat which will kill the plant.

34)

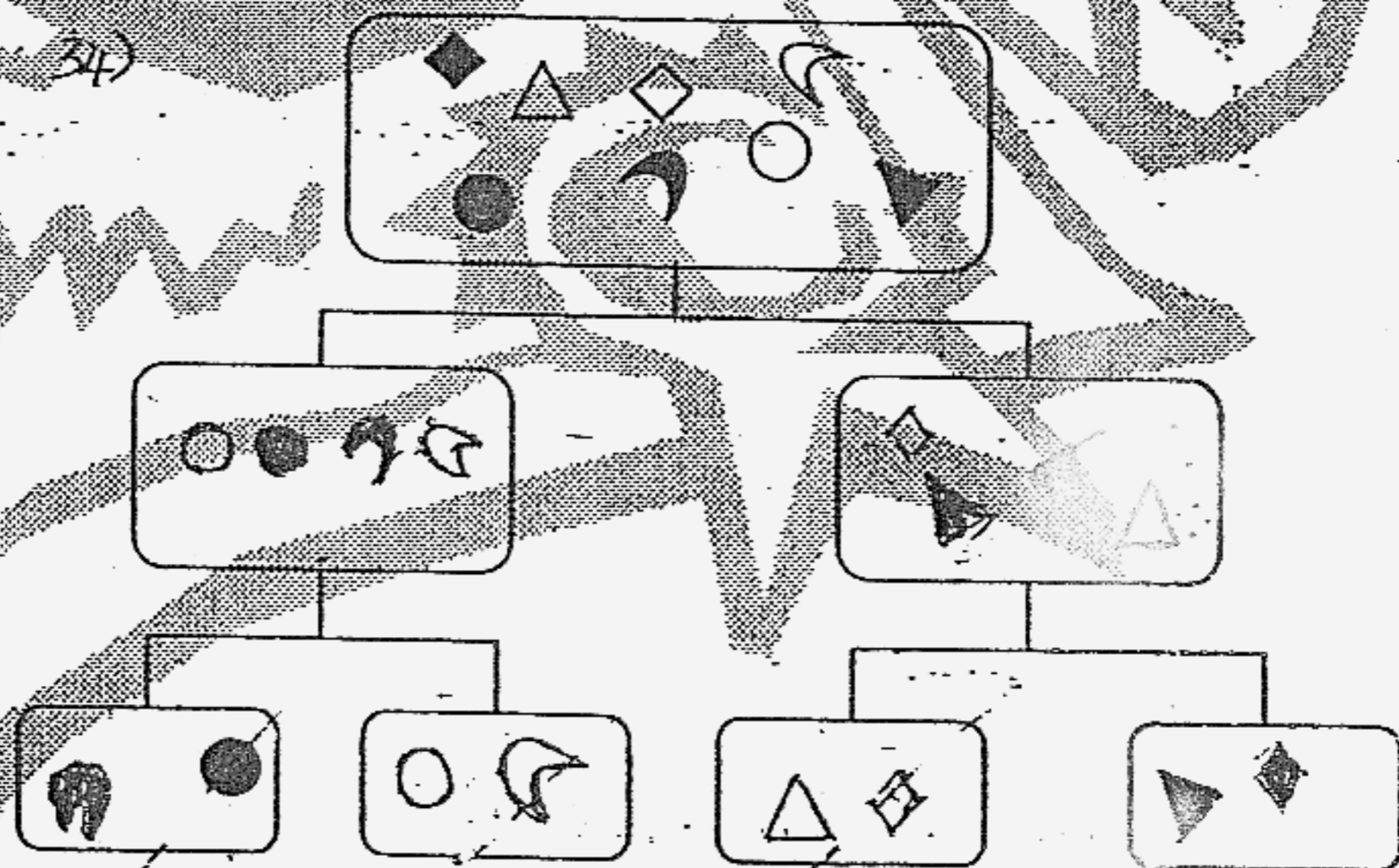

34)b. I classify them whether they are shaded or non-shaded.

35)a. Bird b. C c) The Webbed skin between the toes enable them to swim.

36)a. The population of Organism Z increase.

36)b. Reason 1: An animal that eats organisms is introduced at B

Reason 2: A diseases in killing the organism

37)a. The part is A. Inside part A is the seeds of the brinjal plant and part A is the fruit of the plant.

37)b. It may not produce fruits. Plant will not be able to make enough food to enable to grow normally.

38)a. The organism living after the dam has no water to drink and they would die.

38)b. The villagers can collect water from the rivers easily.

39)a. 350cm^3 39)b. Air can be compressed.

40)a. The water vapour which came out from our mouth condense on cool surface which formed mist.

40)b. As the surface at the mirror becomes warmer, less and less water vapour condenses on it.

41)1. Fill the measuring cylinder with water and record the initial volume.

2. He should pour the same amount of water in the hole until it was full.

3. Record the final volume of water left in measuring cylinder.

4. Calculate the difference between the initial and final volume of water in measuring cylinder

42)a. C, D, B, A

42)b. K:-L, N, M

L:- M:-L, k

N:-L, K

43)a. A and B.

43)b. metal bars A and B seen to repelled from each other meaning to say it was like pole facing each other.

44)a. ozan b. ultra-voilet c. carbon dioxide d. Global warming

45)a.

45)b. i. BC and DE

ii. liquid.

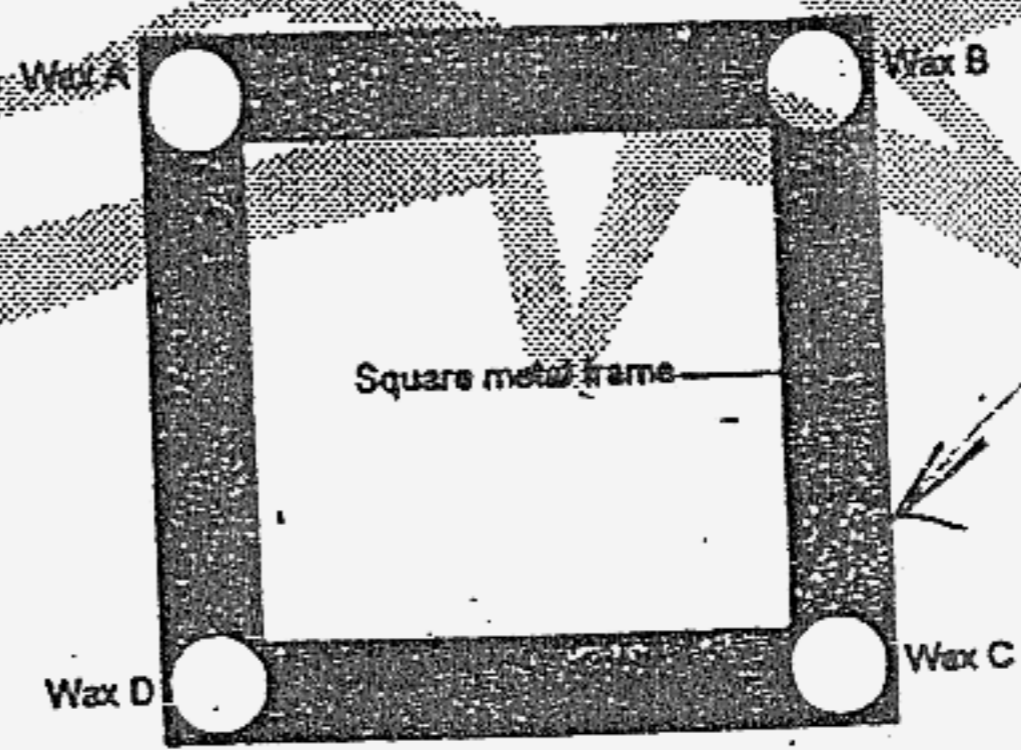

46)a.

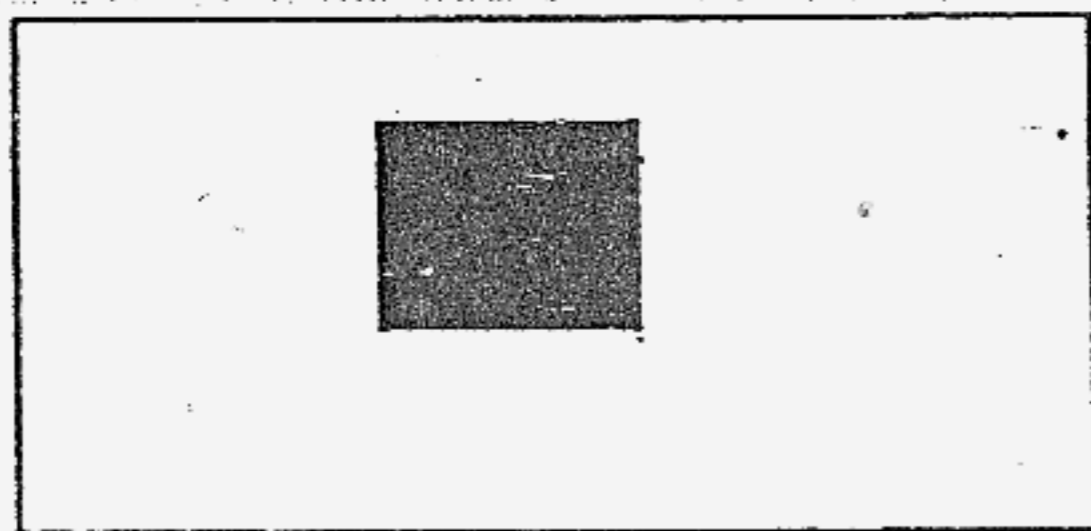

46)b. B

ii. Light travels in a straight line.