

Index No.

--	--	--	--	--	--	--

**NAN HUA PRIMARY SCHOOL**  
**PRIMARY SIX PRELIMINARY EXAMINATION 2006**  
**MATHEMATICS**  
**BOOKLET A**

**15 Questions**

**20 marks**

**Total Time For Booklets A & B : 2 h 15 min**

**INSTRUCTIONS TO CANDIDATES**

**DO NOT OPEN THIS BOOKLET UNTIL YOU ARE TOLD TO DO SO.**

**FOLLOW ALL INSTRUCTIONS CAREFULLY.**

**ANSWER ALL QUESTIONS.**

---

Marks Obtained :

Booklet A

Booklet B

Total

Name : \_\_\_\_\_ ( )

Class : P 6 \_\_\_\_\_

Date : 22 August 2006

Parent's Signature : \_\_\_\_\_

**Section A (20 marks)**

Questions 1 to 10 carry 1 mark each. Questions 11 to 15 carry 2 marks each. For each question, 4 options are given. Only one of them is correct. Make your choice (1, 2, 3 or 4). Shade the correct oval in the optical answer sheet.

1. Find the value of  $12 + 30 \div 3 \times 2$ .

- (1) 7
- (2) 28
- (3) 32
- (4) 44

( )

2. Express 5 kg 3 g in kg.

- (1) 5.3 kg
- (2) 5.03 kg
- (3) 5.003 kg
- (4) 5.0003 kg

( )

3. Which one of the following fractions is arranged in ascending order?

- (1)  $\frac{1}{6}, \frac{1}{7}, \frac{1}{8}, \frac{1}{9}$
- (2)  $\frac{1}{4}, \frac{1}{2}, \frac{3}{5}, \frac{5}{8}$
- (3)  $\frac{3}{4}, \frac{3}{5}, \frac{4}{7}, \frac{4}{8}$
- (4)  $\frac{9}{10}, \frac{17}{20}, \frac{3}{4}, \frac{1}{2}$

( )

4. Simplify  $6m + 17 - 2m - 30$ .

- (1)  $8m + 47$
- (2)  $6m + 47 - 2m$
- (3)  $4m + 13$
- (4)  $4m - 13$

( )

5. Look at the number line below.

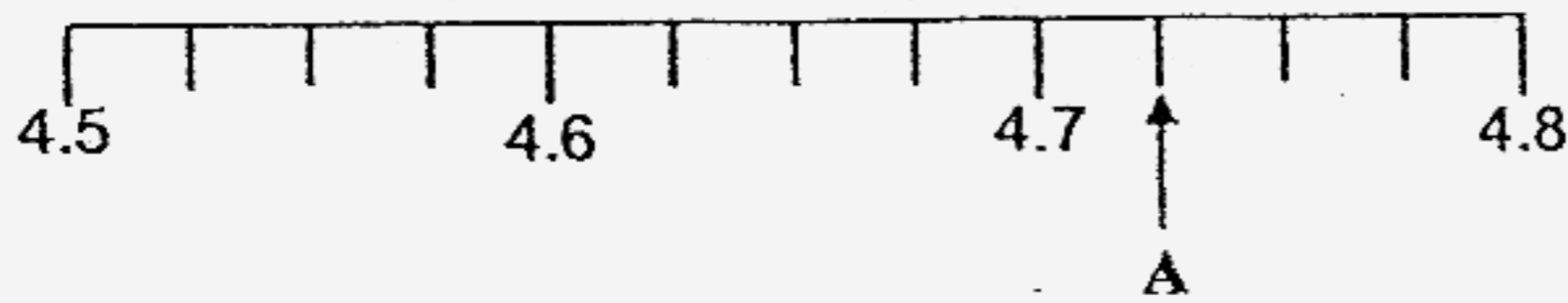

What is the value of "A" in the number line?

- (1) 4.025
- (2) 4.725
- (3) 4.75
- (4) 0.775

( )

6. A printer can print 15 pages a minute. How many pages can it print in 3 hours?

- (1) 45
- (2) 180
- (3) 2 700
- (4) 3 000

( )

7. The figure shows a square and a straight line OA. Find  $\angle a$ .

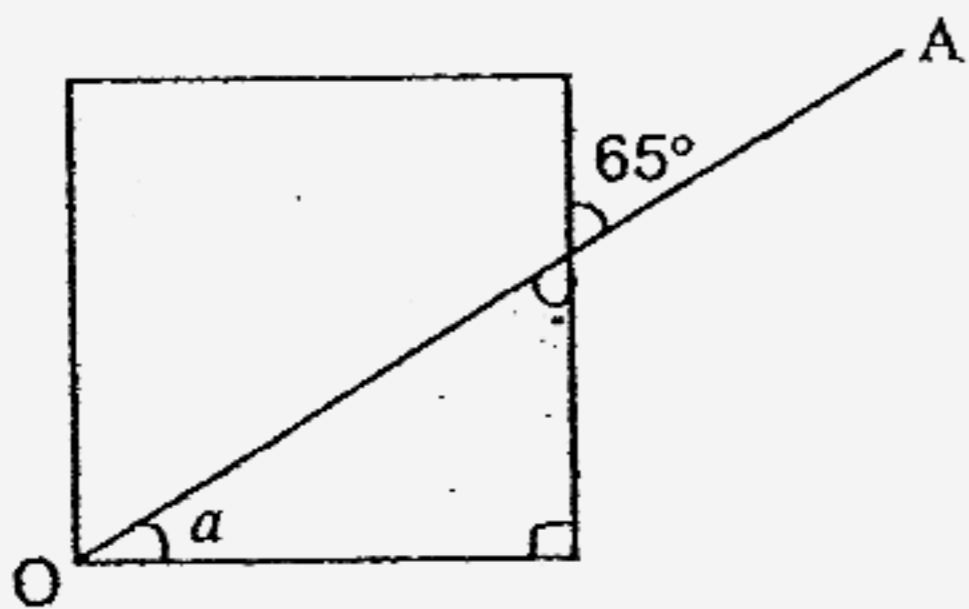

- (1) 25°
- (2) 45°
- (3) 115°
- (4) 135°

( )

8. Five girls have an average mass of 32 kg. When a new girl joins the group, their average mass increases to 35 kg. What is the mass of the new girl?

- (1)  $38\frac{1}{2}$  kg
- (2) 18 kg
- (3) 50 kg
- (4) 53 kg

( )

9. Which of the following has only 4 lines of symmetry?

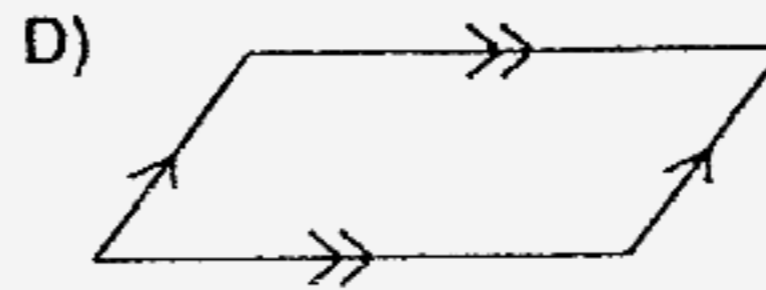
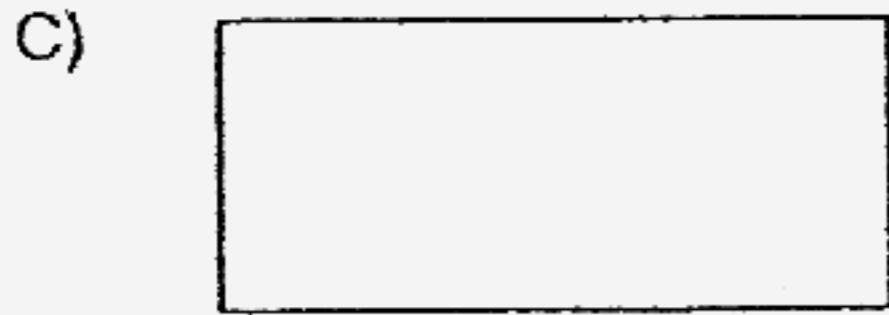
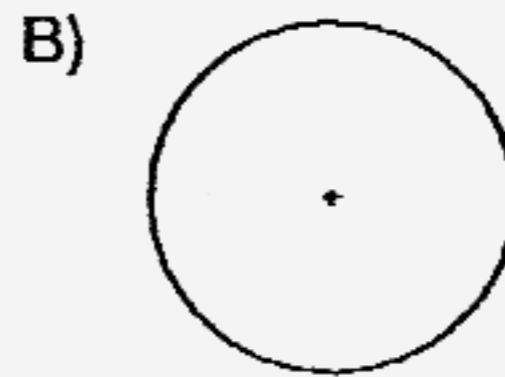

- (1) A only
- (2) A and B
- (3) A, B and D
- (4) All of the above

( )

10. Mrs. Tan bought a handbag at a discount of 15%. She paid \$153 for it. What was the original price of the handbag?

- (1) \$160
- (2) \$180
- (3) \$1020
- (4) \$1100

( )

11. Which of the following is not a NET of a cube?

A)

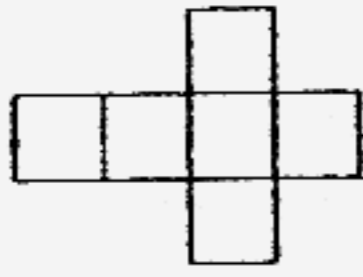

B)

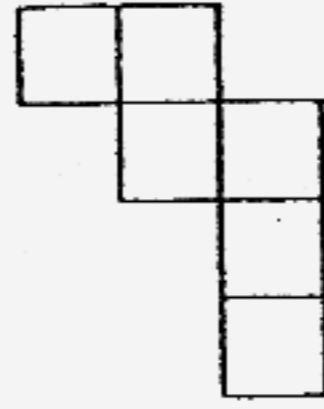

C)

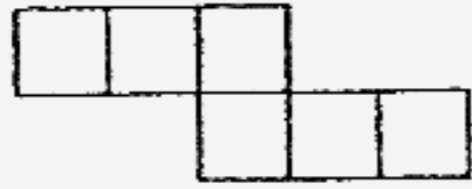

D)

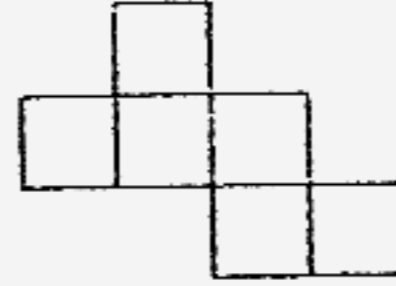

- (1) B only
- (2) C only
- (3) B and C only
- (4) A and B only

( )

12. What is the **maximum** number of circles of radius 3 cm that can be cut out from a rectangle 21 cm by 15 cm?

- (1) 6
- (2) 7
- (3) 15
- (4) 35

( )

13. Between the numbers 10 and 100, how many times will the digit "6" appear?

- (1) 10
- (2) 19
- (3) 20
- (4) 21

( )

14. Express 35 g as a percentage of 4 kg.

- (1) 87.5 %
- (2) 8.75 %
- (3) 0.875 %
- (4) 0.0875 %

( )

15. Mr. Tan drove for 2 hours at an average speed of 85 km/h. Then he reduced his average speed by 15 km/h and covered another 175 km. What is his average speed for the whole journey?

(1)  $76\frac{2}{3}$  km/h

(2)  $77\frac{1}{2}$  km/h

(3) 79 km/h

(4) 158 km/h

( )

NAN HUA PRIMARY SCHOOL

PRIMARY SIX PRELIMINARY EXAMINATION 2006

MATHEMATICS

BOOKLET B

Marks:

/ 80

Name : \_\_\_\_\_ ( )

Class : P 6 \_\_\_\_\_

**SECTION B**

Questions 16 to 25 carry 1 mark each. Write your answers in the spaces provided. For questions which require units, give your answers in the units stated. (10 marks)

---

16. Round off 18.067 to the nearest hundredth.

Answer : \_\_\_\_\_

17.  $24 \times \frac{5}{9} = 14 \times \frac{5}{9} + \frac{5}{9} + \frac{5}{9} + \square \times \frac{5}{9}$

What is the missing number in the box?

Answer : \_\_\_\_\_

18. If  $a = 8$ , find the value of  $3a^2 - 4a - 29$ .

Answer : \_\_\_\_\_

19. In the rectangle  $ABCD$ ,  $E$  &  $F$  are mid-points of  $AC$  &  $BD$  respectively.

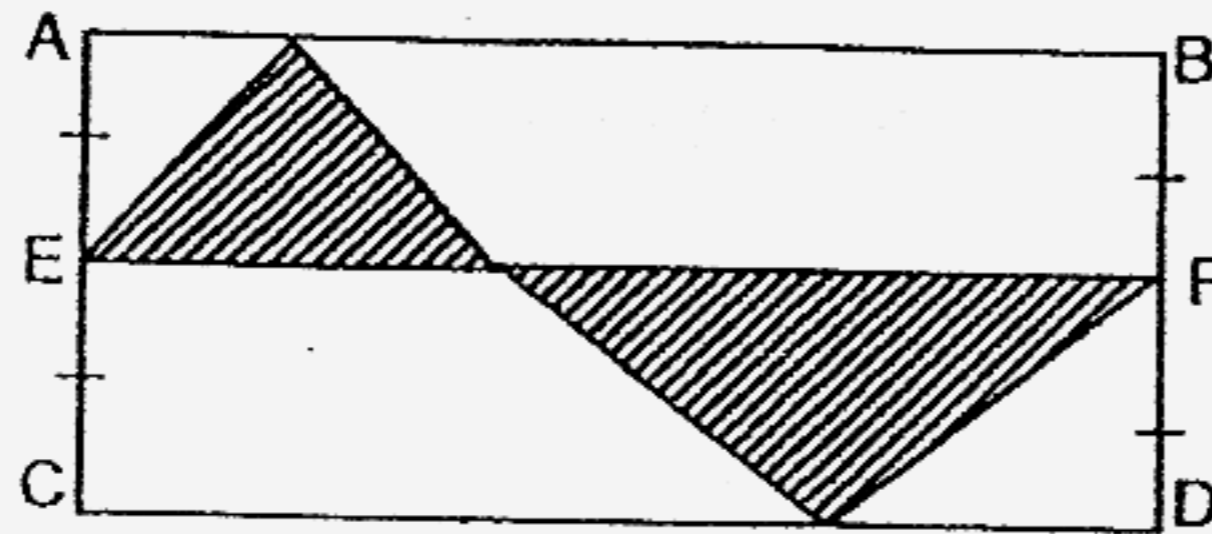

The shaded area is  $\frac{1}{2}$  of rectangle \_\_\_\_\_.

Answer : \_\_\_\_\_

20. 15 copies of Teenage magazine cost \$60. How much will 2 dozen copies cost?

Answer : \$ \_\_\_\_\_

21. Mrs. Tan made some sardine and curry puffs. She packed 3 sardine puffs and 5 curry puffs in each box. Altogether she had 20 boxes. What fraction of the total number of puffs was the curry puffs?

Answer : \_\_\_\_\_

22. The solid is made up of 2-cm cubes. What is its volume?

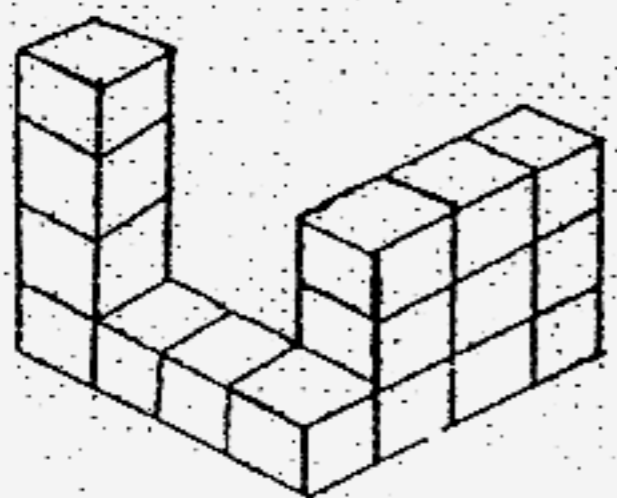

Answer : \_\_\_\_\_  $\text{cm}^3$



23. Equal amount of water is poured into 2 empty tanks A & B as shown below. If Tank A is half-filled, what is the height of the water level in Tank B?

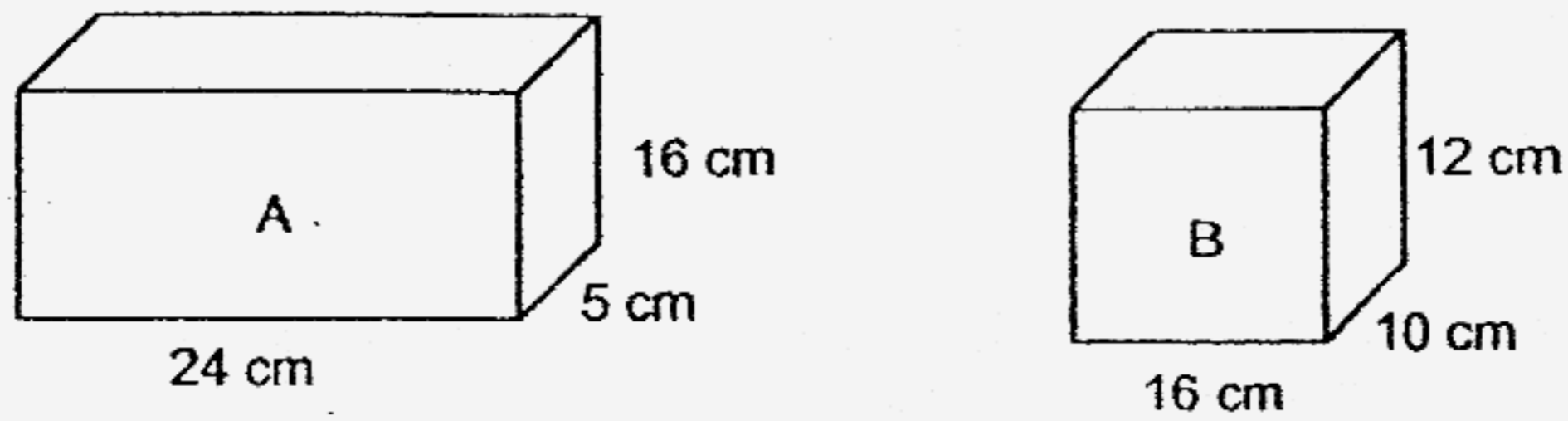

Answer: \_\_\_\_\_ cm

24. The table below shows the time the bus leaves the interchange for the airport.

Leaves Bus Interchange	Arrives at Airport
08 30	09 15
08 45	09 30
✓ 09 20	10 05
09 45	10 30
10 30	11 15

Sandy needs to arrive at the airport before 10 15. What is the latest time that she must board the bus so that she will be punctual?

Answer : \_\_\_\_\_

25. Mrs. Tan can sew a dress in 3 days. Mrs. Leong can sew a similar dress in 4 days. How many days will they take to sew a dress if they sew the dress together?

Answer : \_\_\_\_\_ days

Questions 26 to 35 carry 2 marks each. Show your working clearly in the space below each question and write your answers in the spaces provided. For questions which require units, give your answers in the units stated. (20 marks)

---

26. The sum of three numbers is 766. The first number is twice the second number. The third number is 54 more than the second number. Find the second number.

Answer : \_\_\_\_\_

27. A wheel of diameter 70 cm is rolled from wall A to wall B. If the wheel takes 5 revolutions to reach wall B, what is the distance between wall A & wall B?

(Take  $\pi = \frac{22}{7}$ )

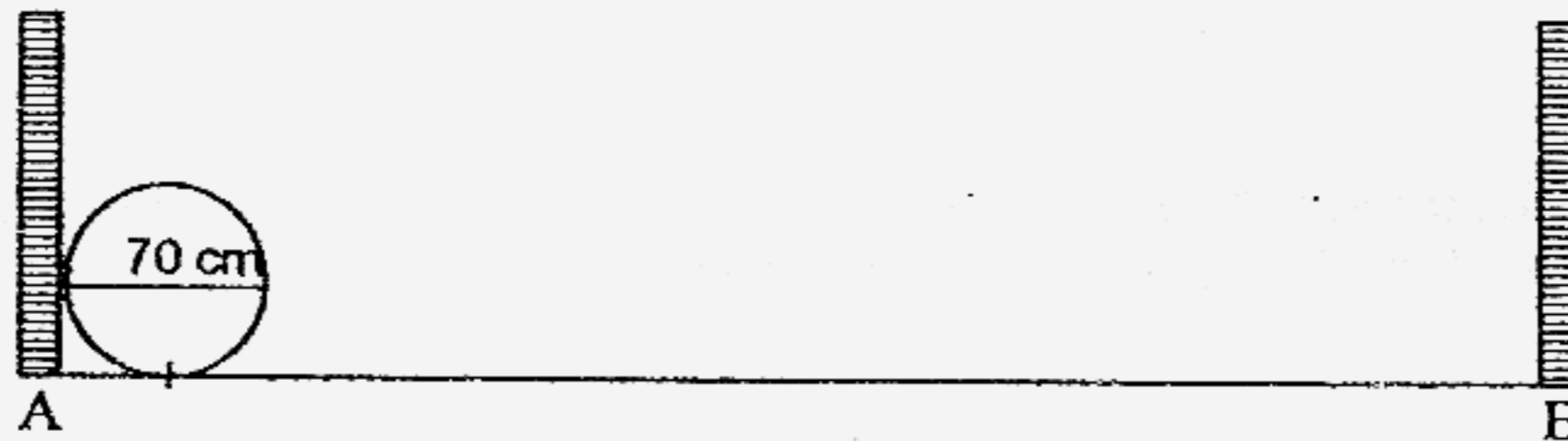

Answer : \_\_\_\_\_ m

28. Simon and Tammy had a cycling race. Simon cycled at an average speed of 15 km/h and Tammy cycled at an average speed of 18 km/h. If Simon started 20 minutes earlier than Tammy, how long would she take to catch up with Simon?

Answer : \_\_\_\_\_ h

29. A square has an area of  $36y^2 \text{ cm}^2$ .  
(a) Find the length of the square.  
(b) Find the perimeter of the square.

Answer : (a) \_\_\_\_\_ cm

(b) \_\_\_\_\_ cm

30. If Adam gives Bobby 20 marbles, he will have the same number of marbles as Bobby. If Bobby gives Adam 40 marbles, the number of marbles he has will be  $\frac{1}{7}$  that of Adam's. How many marbles has Bobby?

Answer : \_\_\_\_\_

31. The rectangle is divided into 4 smaller rectangles. The ratio of their areas of A, B and D is 12 : 5 : 2 respectively. The area of D is 12 cm<sup>2</sup>. What is the area of C?

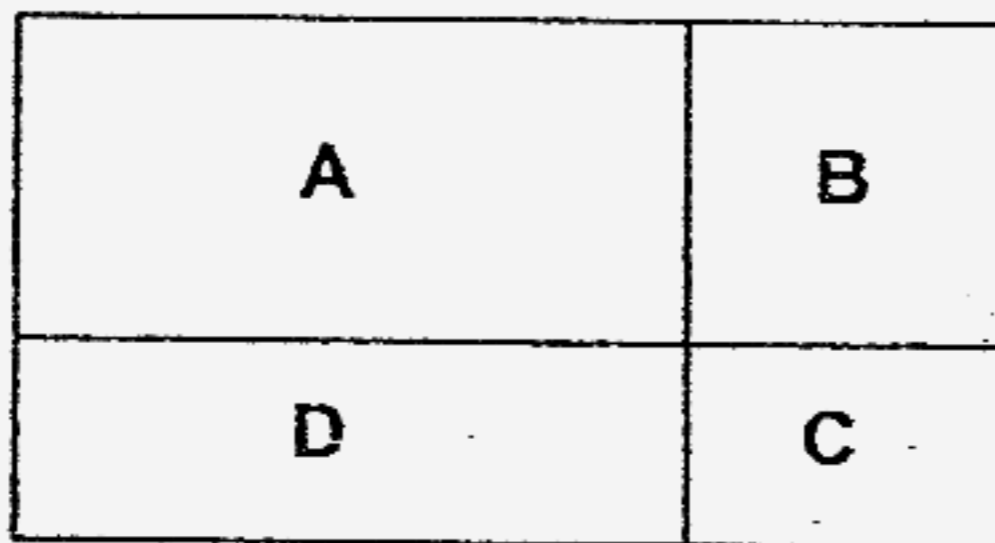

Answer : \_\_\_\_\_

32. In the figure, not drawn to scale, ABCD is a rhombus. Find  $\angle a$ .

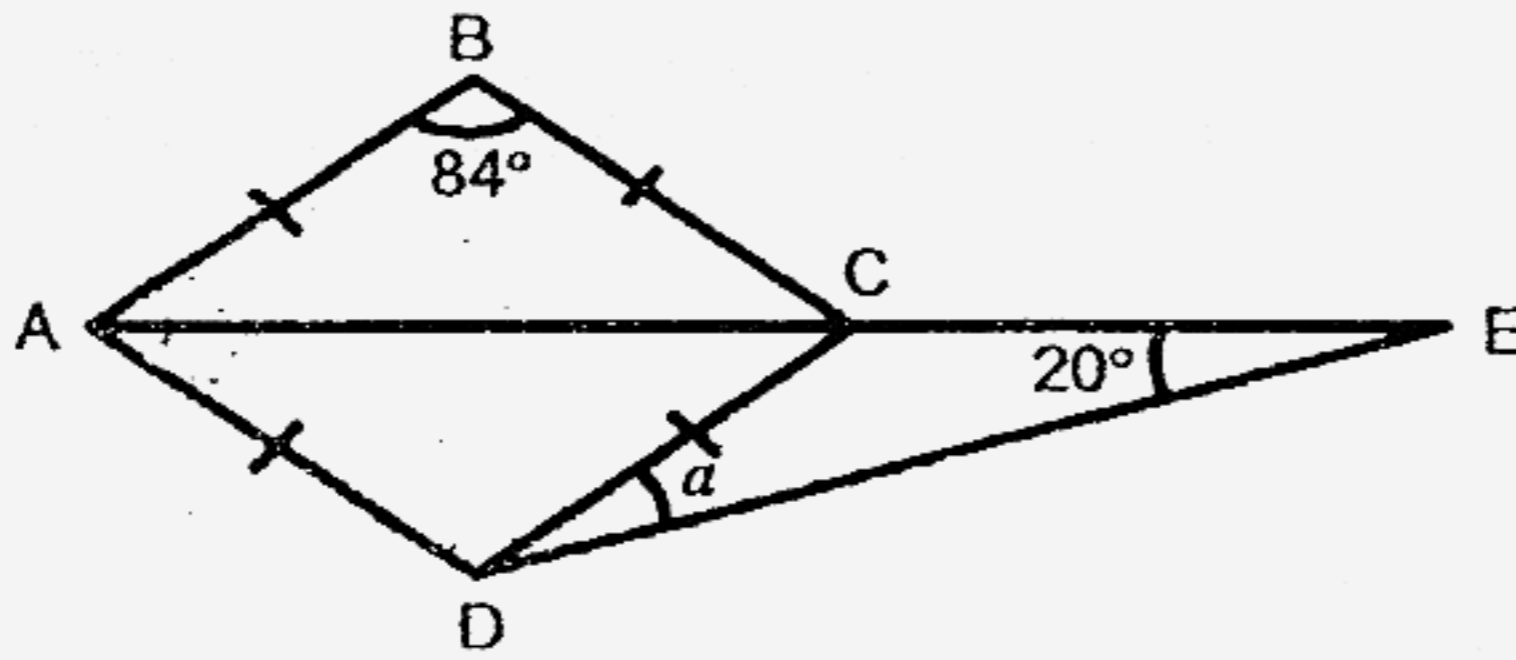

Answer : \_\_\_\_\_

33. How many 3-cm cubes can be cut from a block of wood measuring 27cm by 35cm by 51cm?

Answer : \_\_\_\_\_

34. The pie chart shows the amount of money donated by each family. If the amount of money donated by the Yeo family is \$620, what is the amount donated by the Lim family?

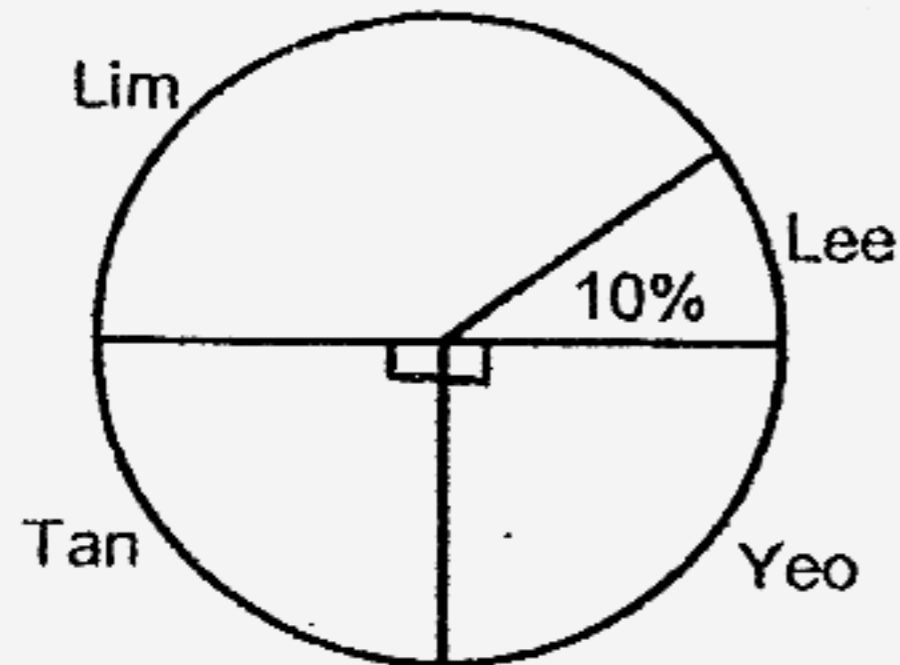

Answer : \$ \_\_\_\_\_

35. There are 40 workers in Bata factory and 35 workers in Reebok factory. 30% of the workers in Bata factory are male while 60% of the workers in Reebok factory are male. The two factories closed down and **all** the workers went to work in Nike factory. How many percent of the workers are male in Nike factory if there are no workers working in there before that?

Answer : \_\_\_\_\_ %

**Section C**

For questions 36 to 48, show your working clearly in the space provided for each question and write your answers in the spaces provided.

The number of marks available is show in brackets [ ] at the end of each question or part-question.

(50 marks)

36. The diagrams below show two different orientations of the same cube. The letters on the faces of the cube are H, A, B, I; T, S:

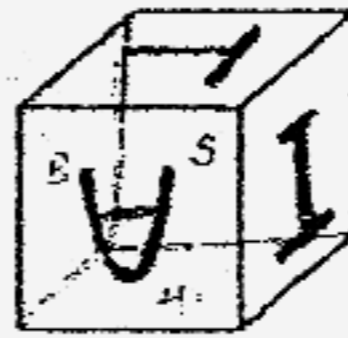
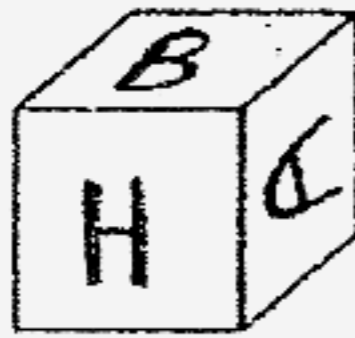

- (a) Which face is opposite to that marked S?  
 (b) Which face is opposite to that marked H?  
 (c) Which face is opposite to that marked B?

Answer : (a) \_\_\_\_\_ [1]

(b) \_\_\_\_\_ [1]

(c) \_\_\_\_\_ [1]

37. Rectangle ABCD is divided into 9 identical small rectangles as shown. Given that the perimeter of rectangle ABCD is 90 cm, find its area.

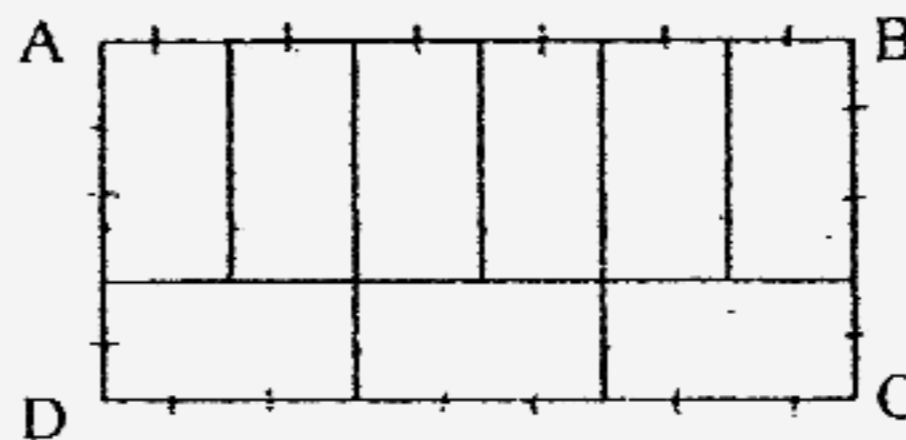

Answer : \_\_\_\_\_ [3]

38. Tessellate the shape on the grid provided. Draw another 7 of the given shape.

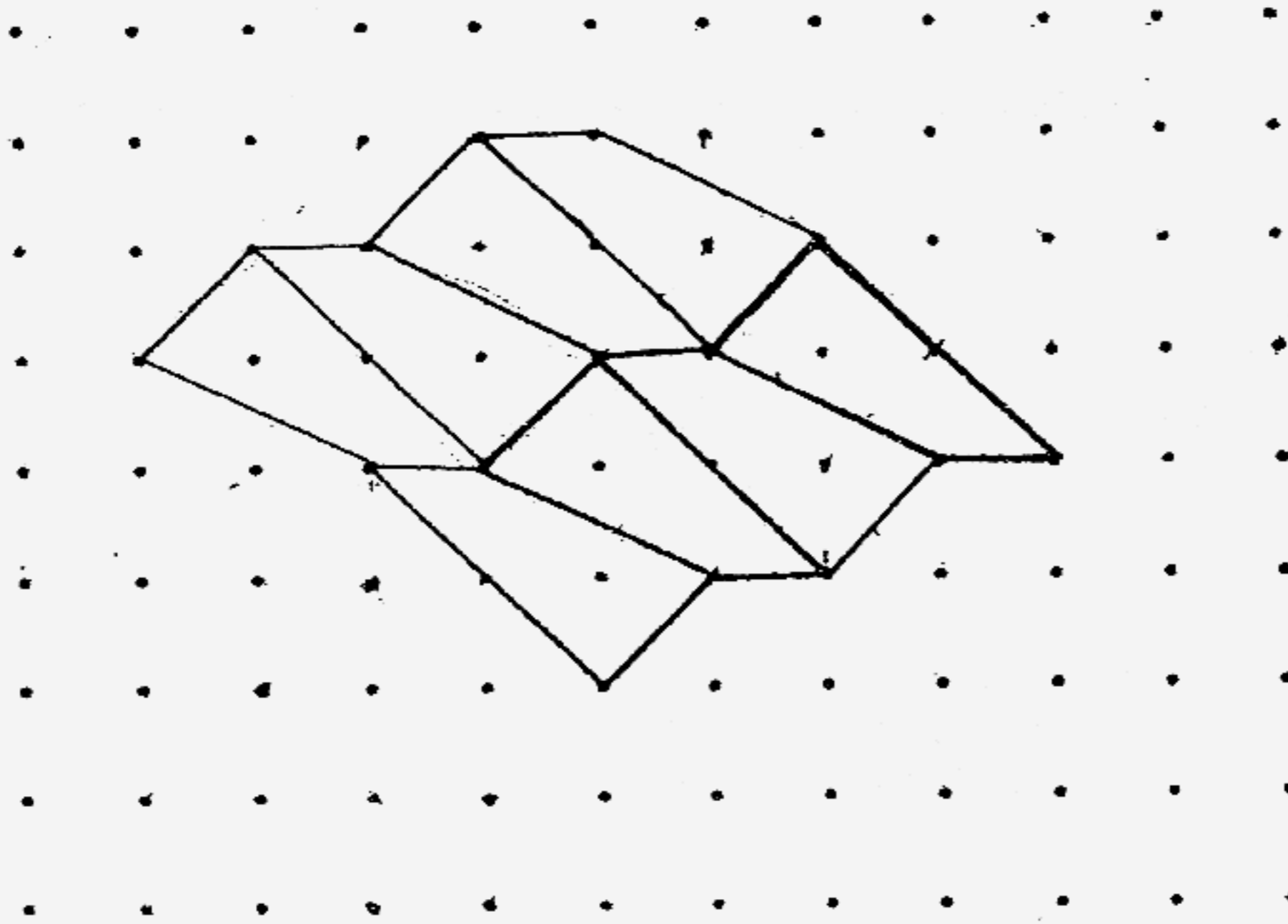

Answer : \_\_\_\_\_ [3]

39. School P has 180 more pupils than School Q. If 60 pupils are being transferred from School Q to School P, there will be 4 times as many pupils in School P as School Q. How many pupils are there in School P?

Answer : \_\_\_\_\_ [3]



40. The ratio of banana trees to papaya trees in an orchard is 4 : 1. When 50% of the banana trees were cut down, there were 420 more banana trees than papaya trees. How many trees were there at first?

Answer : \_\_\_\_\_ [3]

41. The figure shows a trapezium and a triangle. Find,  
 (a)  $\angle x$   
 (b)  $\angle y$

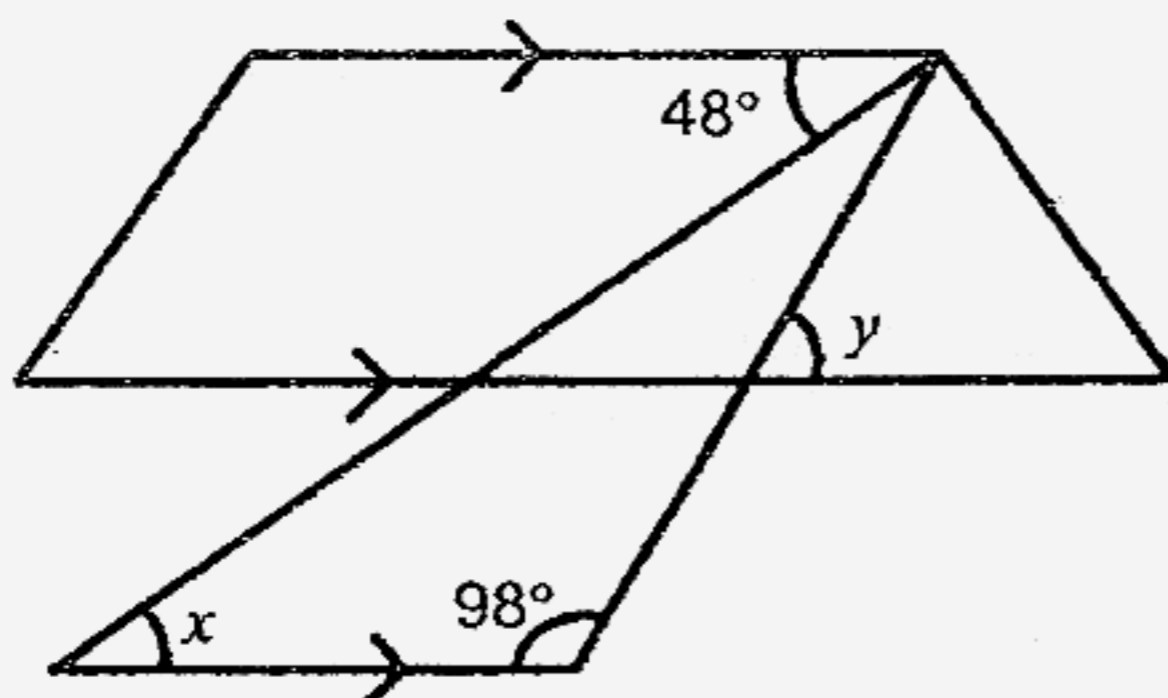

Answer :  $\angle x =$  \_\_\_\_\_ [1]

$\angle y =$  \_\_\_\_\_ [2]

42. The sequence of patterns is formed with squares. The first four patterns are shown below.

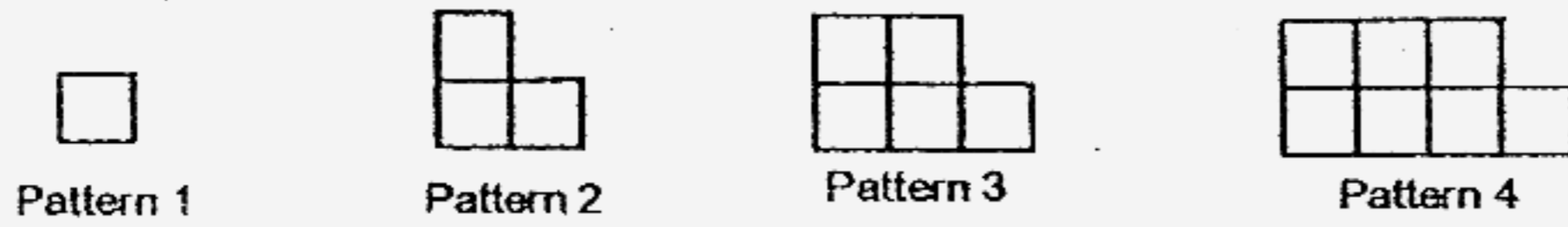

- (a) How many squares are needed for Pattern 7?  
(b) There are 100 squares and some of them are used to form Pattern 50.  
How many squares are left unused?  
(c) Find the pattern that has a total of 205 squares.

Answer : (a) \_\_\_\_\_ [1]

(b) \_\_\_\_\_ [1]

(c) \_\_\_\_\_ [2]

43. Mrs. Chan travelled at 60 km/h from her home to the office. On the way home, she increased her speed by 30 km/h and took 5 minutes less. What was the distance between her home and the office?

Answer : \_\_\_\_\_ [4]

44. A box containing 3 files weighed 10.2 kg. Later Peter added 2 more files and 3 books into the box and the mass of the box with its contents became 19 kg. If the mass of one file was four times the mass of the book,
- (a) find the mass of the box. (Express your answer as a decimal).
  - (b) Peter could only lift a maximum mass of 13 kg. What was the least number of files that he could remove from the box so that he was able to lift the box?

Answer: (a) \_\_\_\_\_ [2]

(b) \_\_\_\_\_ [2]

45. In the figure below, O is the centre of the circle. ABCO is a square and OD is 14 cm. Quadrant OAC is equal to Quadrant BAC. Find the area of the shaded parts.

(Take  $\pi = \frac{22}{7}$ )

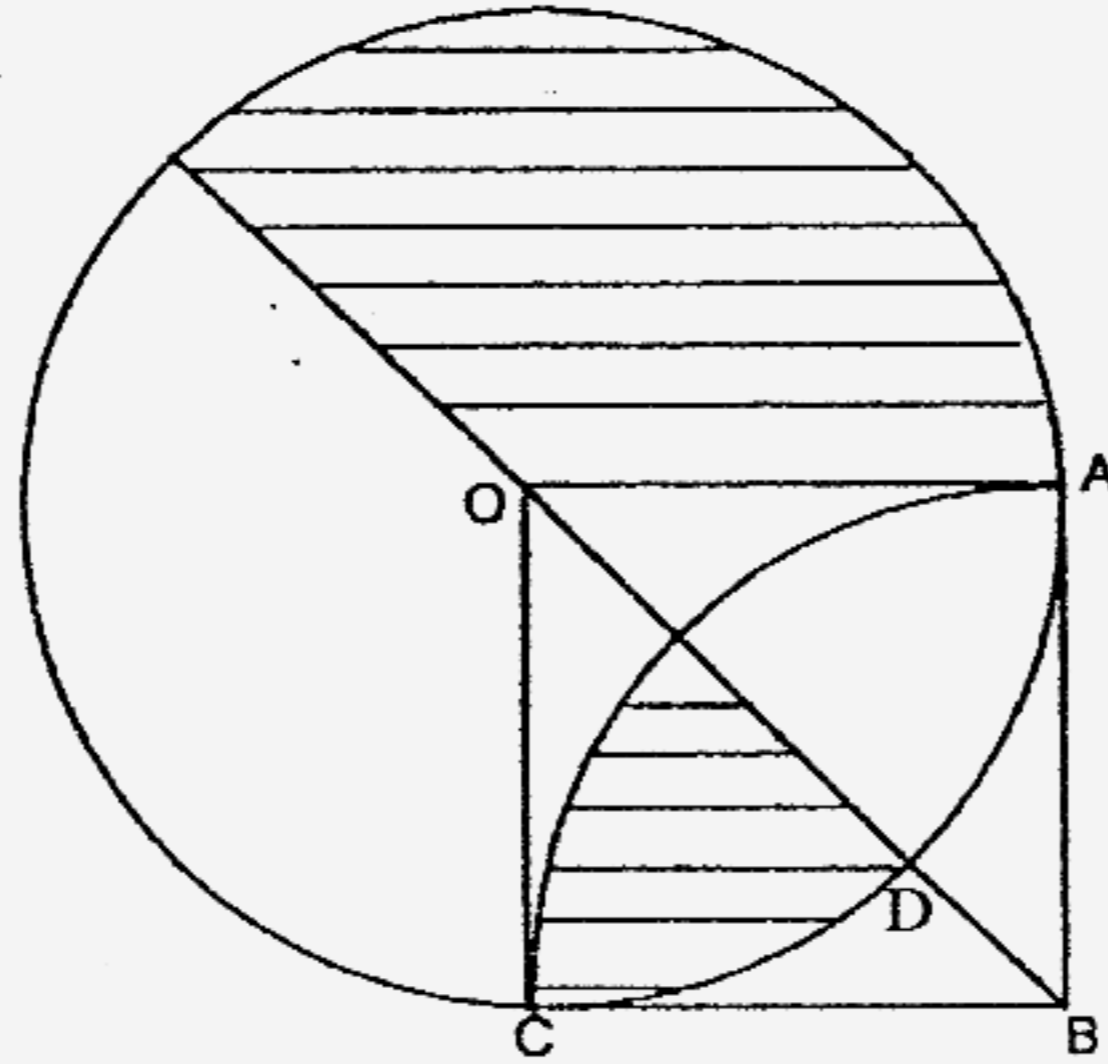

Answer: \_\_\_\_\_ [5]

46. Eight identical 5-cm cubes are placed in an empty rectangular tank of length 75 cm and width 40 cm. The tank is then filled with water running from a tap at the rate of 9 litres per minute. It takes 11 min to fill up  $\frac{2}{3}$  of the tank.
- (a) How much more water is needed to fill up the tank to its brim?  
(Express your answer in litres)
- (b) Find the height of the tank.

Answer : (a) \_\_\_\_\_ [3]

(b) \_\_\_\_\_ [2]

47. At first, Jonathan had  $\frac{2}{3}$  as many stamps as Kevan. After Jonathan bought another 8 stamps and Kevan lost 5 stamps, Jonathan now has  $\frac{4}{5}$  as many stamps as Kevan.  
Find the number of stamps Jonathan had at first.

Answer \_\_\_\_\_ [5]

48. X and Y are two schools in the same cluster. In school X, the ratio of the number of girls to the number of boys is 4 : 1. In school Y, the ratio of the number of girls to the number of boys is 2 : 3. School X has twice as many pupils as school Y.
- (a) Find the ratio of the number of girls in school X to the number of boys in school Y.
- (b) After 40 boys leave school X to join school Y, the ratio of the number of girls to the number of boys in school Y becomes 5 : 8. How many boys are there in school Y now?

Answer : (a) \_\_\_\_\_ [2]

(b) \_\_\_\_\_ [3]

~ the end ~

Q1	Q2	Q3	Q4	Q5
3	3	2	4	2
Q6	Q7	Q8	Q9	Q10
3	1	3	1	2
Q11	Q12	Q13	Q14	Q15
1	1	2	3	1

16. 18.07  
 17. 8  
 18. 131  
 19. ABFE  
 20. \$96.00
21.  $\frac{5}{8}$   
 22. 128cm<sup>3</sup>  
 23. 6cm  
 24. 0920  
 25.  $1\frac{5}{7}$  days

26.	178	27.	$220 \times 5 + 70 = 1170\text{cm}$ $= 11.7\text{m}$
28.	$\frac{1}{3} \times 15 = 5$ $\frac{5}{3} = 1\frac{2}{3}$ hours	29a.	6ycm
30.	$3u = 60$ $4u = 80$ $80 - 20 = 60$	29b.	27ycm
32.	28	31.	5cm <sup>2</sup>
		33.	1683

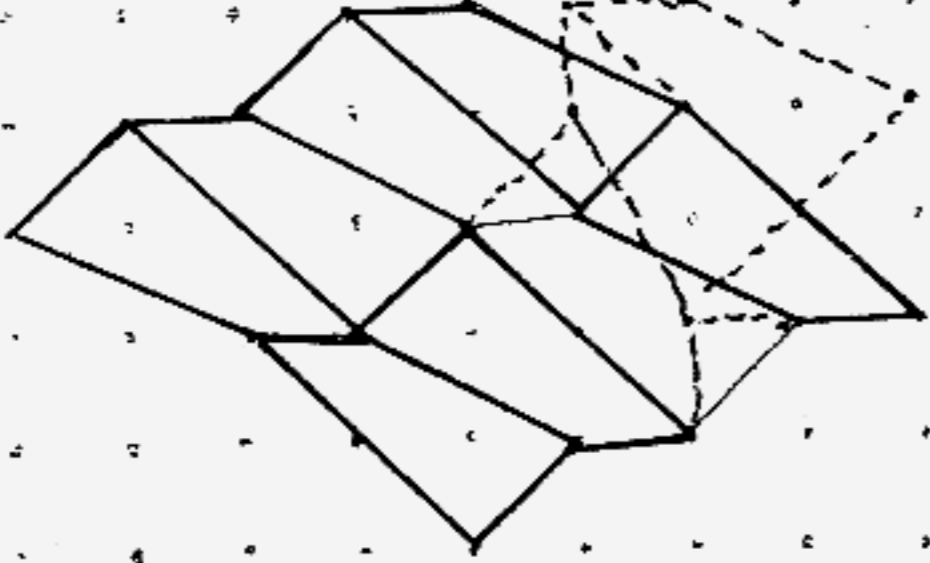

<p>34.</p>	<p>25% = 620 5% = 124 40% = 992</p> <p>The amount donated by the Lim's family is <u>\$992.00</u> (Ans)</p>	<p>35.</p>	<p><math>\frac{30}{100} \times 40 = 12</math> (Bata' workers) 40 = 12 = 28</p> <p><math>\frac{60}{100} \times 35 = 21</math> (Reebok's workers) 35 - 21 = 14</p> <p>12 + 21 = 33 40 + 35 = 75 = <math>\frac{33}{75} \times 100 = 44\%</math></p> <p><u>44%</u> are male in Nike factory (Ans)</p>
<p>36.</p>	<p>A - opposite S I - opposite B T - opposite H</p> <p>a. It is face A b. It is face T c. It is face I</p>	<p>37.</p>	<p><math>B = \frac{1}{2} \text{hr}</math></p> <p>90 = 30 + 30 + 15 + 15 = 30 x 15 = 450</p> <p>It is area if <u>450cm<sup>2</sup></u> (Ans)</p>
<p>38.</p>		<p>39.</p>	<p>3u = 180 + 60 + 60 = 300 1u = 100 4u = 400 = 400 - 60 = 340 pupils.</p> <p>There are <u>340 pupils</u> (Ans)</p>
<p>40.</p>	<p><math>\frac{1}{2} \times 4 = 2</math> 2u - 1u = 1u 1u = 420 5u = 2100</p> <p>There are <u>2100 trees</u> at first. (Ans)</p>	<p>41.</p>	<p>X = 48° (Z) = 180° - 98 = 82°</p> <p>a. Lx = 48° b. Ly = 82°</p>

<p>42a. Pattern = <math>(n \times 2) - 1</math>  <math>= (7 \times 2) - 1 = 13</math></p> <p>13 squares are needed.</p> <p>42b. <math>(n \times 2) - 1</math>  <math>(50 \times 2) - 1 = 99</math>  1 square is left unused.</p> <p>42c. <math>(n + 1) \div 2</math>  <math>(205 + 1) \div 2 = 103</math>  It is pattern <u>103</u>. (Ans)</p>	<p>43. <math>60 + 30 = 90</math></p> $\frac{1}{12} \times 60 = 5$ $\frac{5}{30} \text{ hr} = \frac{1}{6} \text{ hr}$ $\frac{1}{6} \text{ hr} \times 90 = 15$ <p>It was <u>15km</u>. (Ans)</p>
<p>44. <math>(2 \times 4) + 3 = 11</math></p> $19 - 10.2 = 8.8$ <p>11 books = 8.8  1book = 0.8  4 books (1 file) = 3.2  3 files = 9.6  <math>= 10.2 - 9.6 = 0.6</math></p> <p>a. It is 0.6kg</p> <p>b. Remove 1 file = <math>19 - 3.2 = 15.8</math>  Remove 2 files = <math>19 - (3.2 \times 2) = 12.6</math>  He could remove <u>2 files</u>. (Ans)</p>	<p>45. <math>\frac{3}{8} \times \frac{22}{7} \times 14 \times 14 = 231</math></p> $\frac{1}{2} \times 14 \times 14 = 98$ $\frac{1}{8} \times \frac{22}{7} \times 14 \times 14 = 77$ $98 - 77 = 21$ $98 - 21 - 21 = 56$ $= 56 + 231$ $= 287$ <p>The area is <u>287cm<sup>2</sup></u> (Ans)</p>
<p>46. <math>5 \times 5 \times 5 = 125</math>  <math>125 \times 8 = 1000</math>  <math>9000 \times 11 = 99000</math>  <math>99000 + 1000 = 100000</math></p> $\frac{2}{3} = 100000$ $\frac{1}{3} = 50000 \text{ (50€)}$ <p>a. <u>50€</u> is needed.</p> <p>b. <math>150000 \div 75 \div 40 = 50</math>  It is <u>50cm</u> (Ans)</p>	<p>47. J : K  2 : 3  60 : 90</p> $60 + 8 = 68$ $90 - 5 = 85$ $\frac{68}{85} = \frac{4}{5}$ <p>J : K  60 : 90</p> <p>Jonathan had <u>60 stamps</u> at first. (Ans)</p>

48.

$$\begin{array}{l} \underline{X} \\ G : B : T \\ 4 : 1 : 5 \\ 8 : 2 : 10 \end{array}$$

$$\begin{array}{l} \underline{Y} \\ G : B : T \\ 2 : 3 : 5 \end{array}$$

$$\begin{array}{l} \underline{\text{After}} \\ G : B \\ 5 : 8 \\ 10 : 16 \end{array}$$

$$\begin{array}{l} \underline{\text{Before}} \\ G : B \\ 2 : 3 \\ 10 : 15 \end{array}$$

$$\begin{array}{l} \underline{X} \\ G : B \\ 8 : 2 \end{array}$$

$$\begin{array}{l} \underline{Y} \\ G : B \\ 2 : 3 \end{array}$$

$$\begin{array}{l} 16 - 15 = 1 \\ 1u = 40 \\ 16u = 640 \end{array}$$

$$\begin{array}{l} G : B \\ 8 : 3 \end{array}$$

a.

The ratio is 8 : 3 (Ans)

b.

There are 640 boys. (Ans)