



UNIVERSITY OF CAMBRIDGE INTERNATIONAL EXAMINATIONS  
General Certificate of Education Ordinary Level

**PHYSICS**

**5054/12**

Paper 1 Multiple Choice

**October/November 2012**

**1 hour**

Additional Materials: Multiple Choice Answer Sheet  
Soft clean eraser  
Soft pencil (type B or HB is recommended)



**READ THESE INSTRUCTIONS FIRST**

Write in soft pencil.

Do not use staples, paper clips, highlighters, glue or correction fluid.

Write your name, Centre number and candidate number on the Answer Sheet in the spaces provided unless this has been done for you.

There are **forty** questions on this paper. Answer **all** questions. For each question there are four possible answers **A, B, C** and **D**.

Choose the **one** you consider correct and record your choice in **soft pencil** on the separate Answer Sheet.

**Read the instructions on the Answer Sheet very carefully.**

Each correct answer will score one mark. A mark will not be deducted for a wrong answer.  
Any rough working should be done in this booklet.

This document consists of **14** printed pages and **2** blank pages.



- 1 The level of water in a measuring cylinder is  $75 \text{ cm}^3$ . A stone of volume  $20 \text{ cm}^3$  is lowered into the water.

What is the new reading of the water level?

- A  $20 \text{ cm}^3$       B  $55 \text{ cm}^3$       C  $75 \text{ cm}^3$       D  $95 \text{ cm}^3$

- 2 The diagram shows three forces acting on a block.



Which additional force will produce a resultant force of 3 N to the left?

- A 3 N to the left  
 B 6 N to the right  
 C 9 N to the left  
 D 13 N to the right
- 3 A table-tennis ball is released from the top of an evacuated tube.

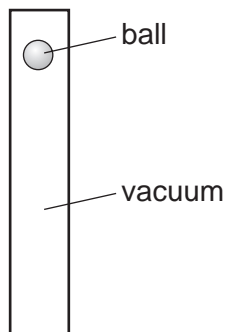

Which graph shows how the speed of the ball changes with time as it falls to the bottom of the tube?

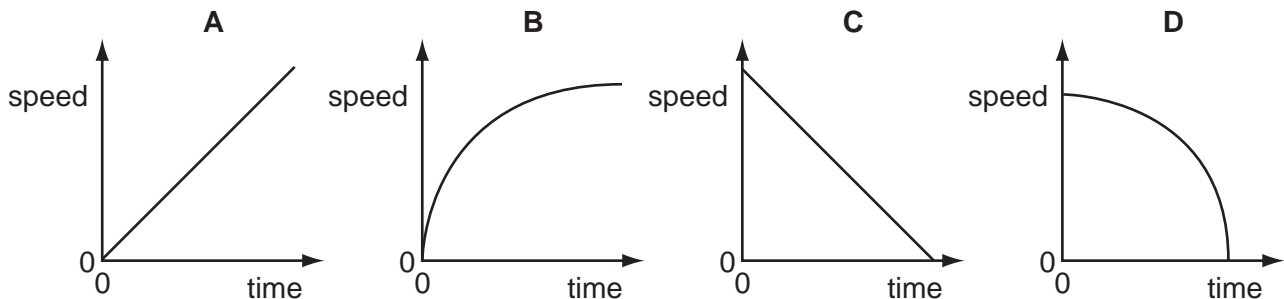

4 The speed-time graph for a car is shown.

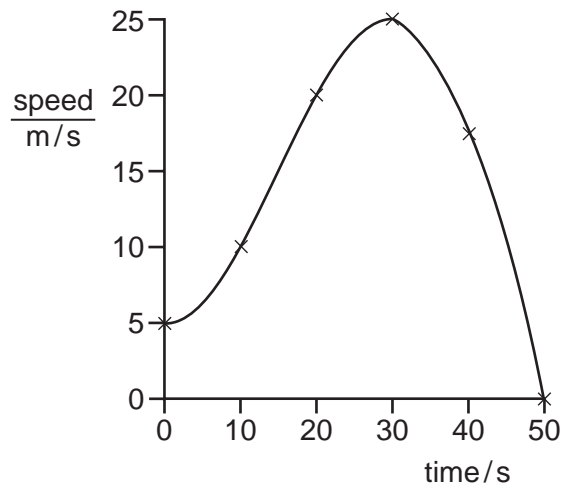

What is the acceleration of the car at 30 s?

- A 0                      B  $\frac{25-5}{30} \text{ m/s}^2$                       C  $\frac{25}{30} \text{ m/s}^2$                       D  $\frac{25}{50} \text{ m/s}^2$

5 The diagram shows a firework rocket.

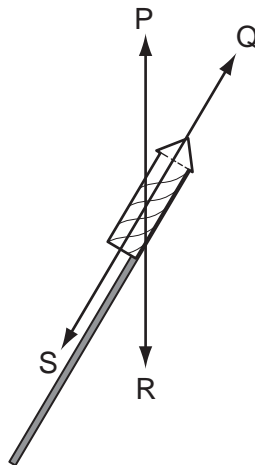

As the rocket flies through the air, three forces act on it. These forces are weight, thrust and air resistance.

What are the three forces?

	thrust	air resistance	weight
<b>A</b>	P	R	S
<b>B</b>	P	S	R
<b>C</b>	Q	R	S
<b>D</b>	Q	S	R

- 6 An object has a mass of 15 kg. It is pushed horizontally by a force of 40 N. The frictional force is 10 N.

What is the acceleration of the object?

- A**  $0.50 \text{ m/s}^2$     **B**  $1.5 \text{ m/s}^2$     **C**  $2.0 \text{ m/s}^2$     **D**  $2.7 \text{ m/s}^2$

- 7 An object Y is in a fixed position on a rod. A weight X is moved and the position of a pivot is adjusted until the rod balances on the pivot, as shown.

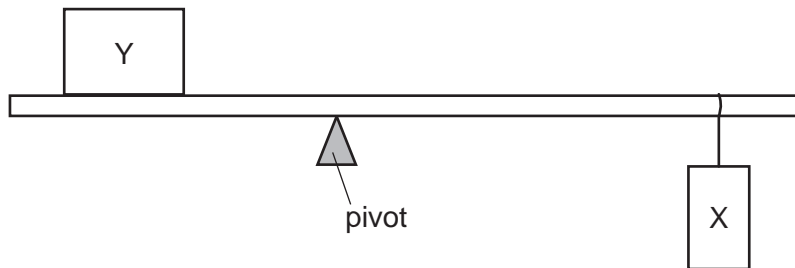

The experiment is repeated in a region where the gravitational field strength is lower.

What is done to keep the rod balanced?

	pivot	X
<b>A</b>	move left	no movement
<b>B</b>	move right	move left
<b>C</b>	no movement	move right
<b>D</b>	no movement	no movement

- 8 Four solid uniform cones have equal weight. They are placed on a bench as shown in the scale diagram.

Which cone is the most stable?

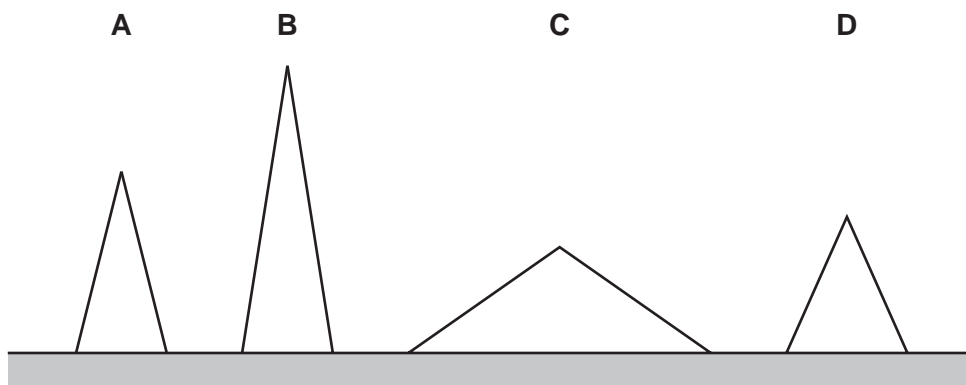

- 9 The diagram shows how the length of a spring changes when a load of 10 N is hung on it.

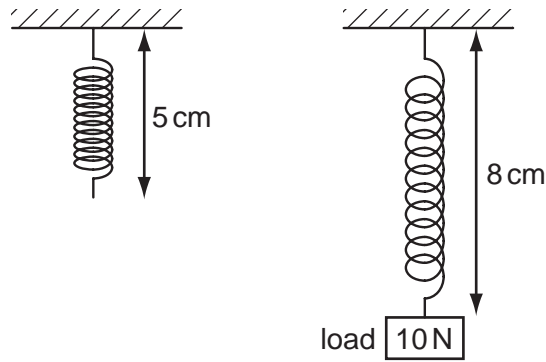

The 10 N load is replaced by a 20 N load. What is the new length of the spring?

- A 6 cm                      B 11 cm                      C 14 cm                      D 16 cm
- 10 The mass and the volume of a bar made from metal X are measured.

The masses and volumes of four other bars are measured.

Which bar is made from a metal with a density that is double that of X?

	mass compared with X	volume compared with X
<b>A</b>	double	half
<b>B</b>	half	same
<b>C</b>	same	double
<b>D</b>	same	half

- 11 Four solid blocks with flat surfaces are placed on some soft plasticine, in the positions shown.

Which block sinks the deepest into the plasticine?

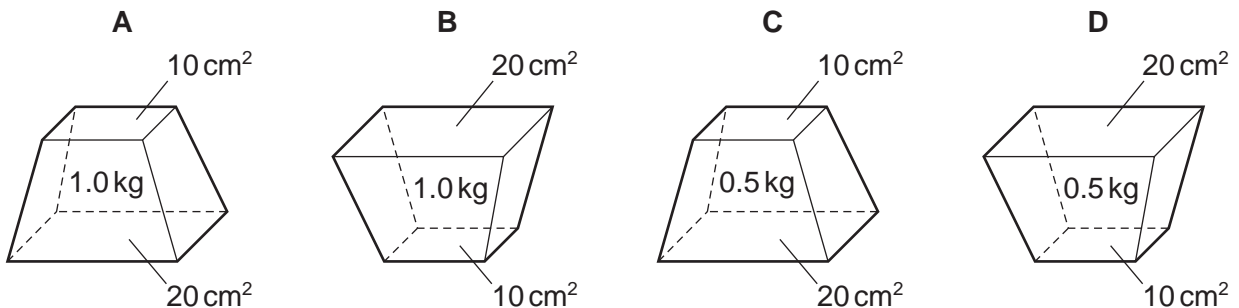

- 12 The end of a bicycle pump is sealed.

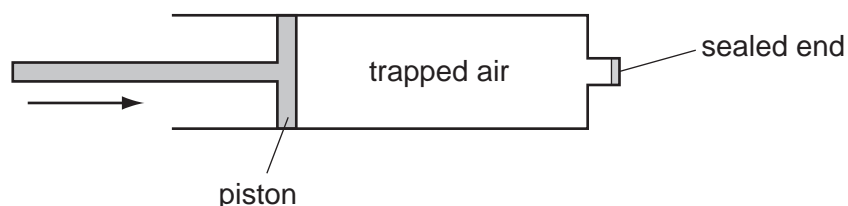

The temperature of the air does not change as the piston is pushed in. The final volume of trapped air is  $\frac{1}{4}$  of the original volume.

How does the pressure of the trapped air change?

- A** It decreases to  $\frac{1}{4}$  of the original value.
- B** It decreases to  $\frac{3}{4}$  of the original value.
- C** It increases to 3 times the original value.
- D** It increases to 4 times the original value.
- 13 Hydroelectric, tidal and fossil fuel power stations generate electrical energy.

Do these use renewable sources of energy?

	hydroelectric	tidal	fossil fuel
<b>A</b>	no	yes	yes
<b>B</b>	no	no	yes
<b>C</b>	yes	no	no
<b>D</b>	yes	yes	no

- 14 An object of mass 5 kg is carried a distance of 4 m across a room at a constant height above the floor.

What is the work done on the object?

- A** 0                      **B** 20 J                      **C** 50 J                      **D** 200 J
- 15 A gas in a container of fixed volume is heated.

What happens to the molecules of the gas?

- A** They collide less frequently.
- B** They expand.
- C** They move faster.
- D** They move further apart.

- 16 In hot weather, people use electric fans to keep cool.

Why do the fans make them feel cool?

- A They change one form of energy into another.
- B They cool the air in the room.
- C They increase the rate of evaporation from the skin.
- D They speed up the vibration of air molecules.

- 17 Four metal cans are identical except for the colour and the texture of their outer surfaces.

100 cm<sup>3</sup> of water at 70 °C is poured into each can.

Which cools the most rapidly?

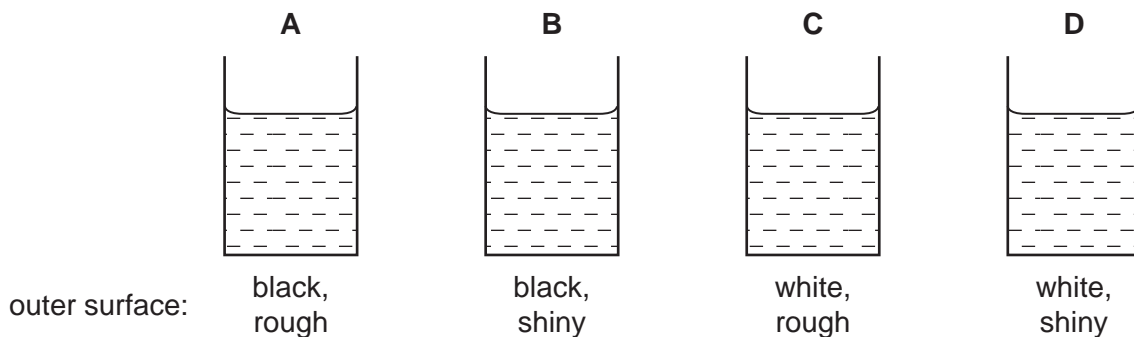

- 18 A liquid-in-glass thermometer consists of a bulb containing a liquid which expands into a very thin capillary tube.

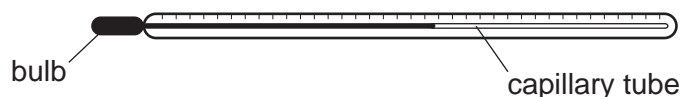

The liquid in the thermometer is replaced by the same volume of a different liquid that expands more for the same temperature rise.

The new thermometer will have

- A greater sensitivity and a greater range.
  - B greater sensitivity but a smaller range.
  - C the same sensitivity and the same range.
  - D the same sensitivity but a greater range.
- 19 An ice cube, at a temperature of 0 °C, has a mass of 10 g. The specific latent heat of fusion of water is  $3 \times 10^5$  J/kg.

How much heat energy is needed to convert the ice cube into 10 g of water at 0 °C?

- A 30 J
- B 3000 J
- C  $3 \times 10^4$  J
- D  $3 \times 10^6$  J

- 20 A strip is made from two metals joined together. The diagrams show the strip at room temperature and after it has been cooled.



at room temperature

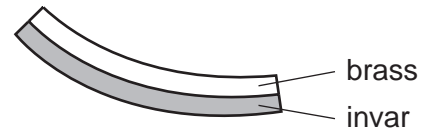

below room temperature

The change in shape occurs because

- A brass contracts more than invar.
  - B brass expands when it cools down.
  - C invar and brass contract by equal amounts.
  - D invar contracts more than brass.
- 21 In a ripple tank, a vibrator produces circular wavefronts which hit a flat surface.

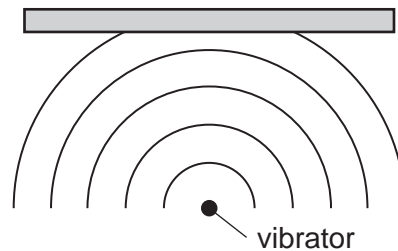

The reflected wavefronts are also parts of circles. Where is the centre of these circles?

A ●

B ●



D ● vibrator

- 22 An object is placed in front of a plane mirror. The image produced is

- A real and smaller than the object.
- B real and the same size as the object.
- C virtual and smaller than the object.
- D virtual and the same size as the object.



23 A ray of red light enters a semi-circular glass block normal to the curved surface.

Which diagram shows the partial reflection and refraction of the ray?

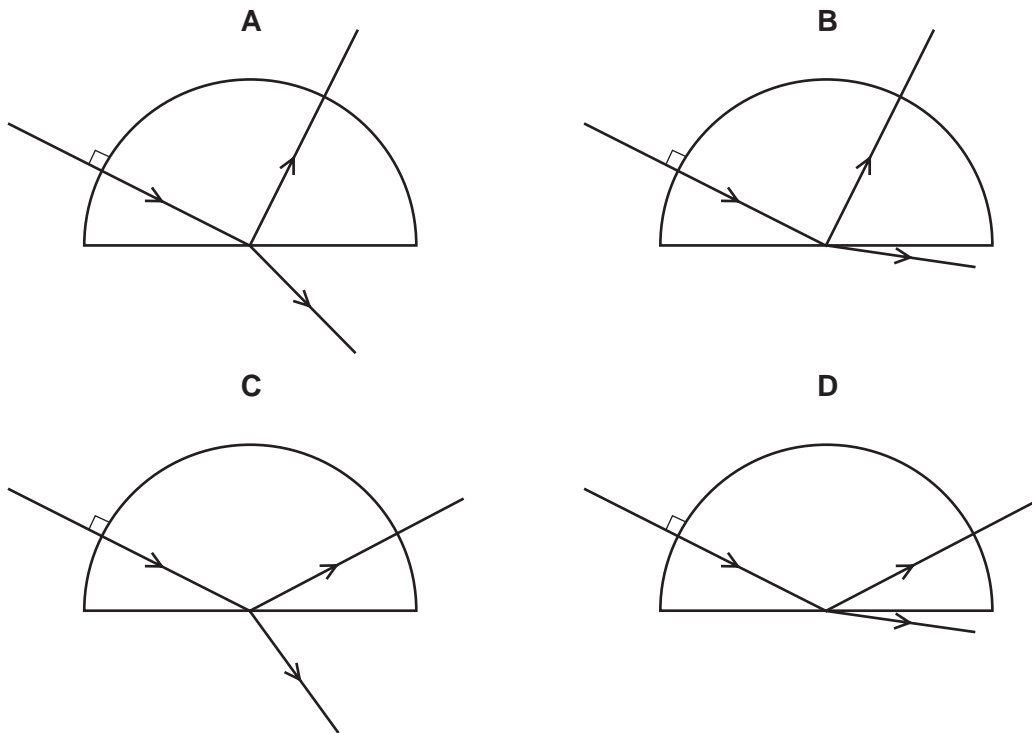

24 A lens is used to produce a magnified image, as shown in the scale diagram.

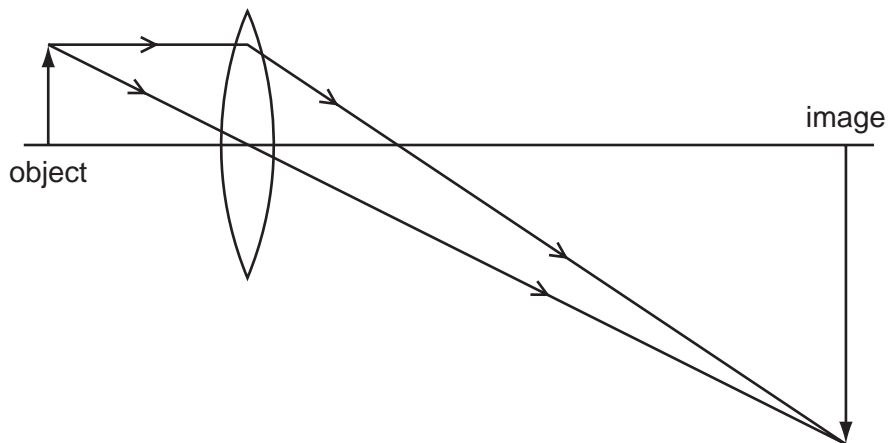

What is the linear magnification of the object?

- A** 0.33      **B** 3.0      **C** 4.0      **D** 6.0

25 Which statement about red light and blue light is correct?

- A** Red light has a higher frequency than blue light.  
**B** Red light has a longer wavelength than blue light.  
**C** Red light has the same speed in glass as blue light.  
**D** Red light is refracted by a glass prism more than blue light.

26 A magnet is placed close to an iron bar.



The iron bar becomes an induced magnet.

Which magnetic poles are formed at the ends X and Y of the bar?

	end X	end Y
<b>A</b>	N	N
<b>B</b>	N	S
<b>C</b>	S	N
<b>D</b>	S	S

27 A small uncharged metal sphere hangs from an insulating thread.

A negatively-charged rod moves close to the sphere.

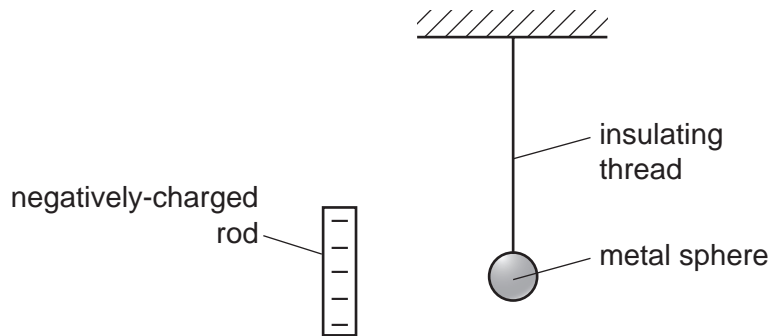

Which diagram shows the charges on the sphere and its final position?

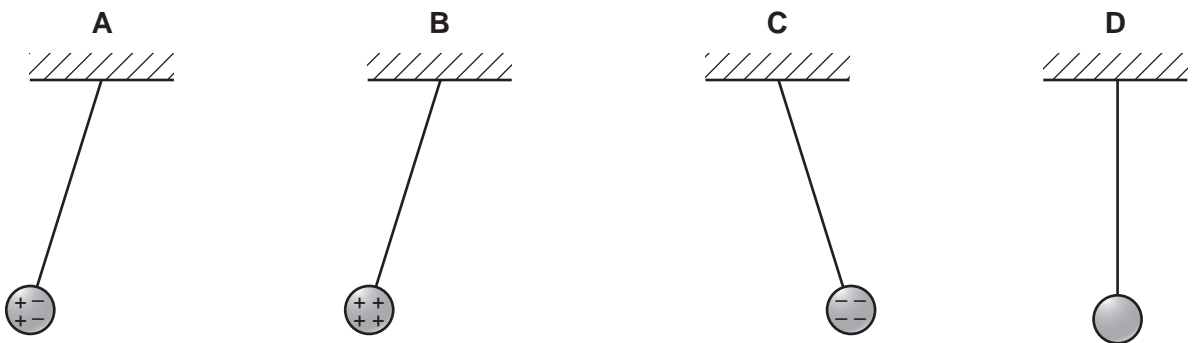

28 A metal wire has length  $l$  and cross-sectional area  $A$ .

What is the resistance proportional to?

- A**  $A + l$       **B**  $\frac{A}{l}$       **C**  $\frac{l}{A}$       **D**  $l \times A$

- 29 A student joins three  $6\ \Omega$  resistors as shown in the diagram.

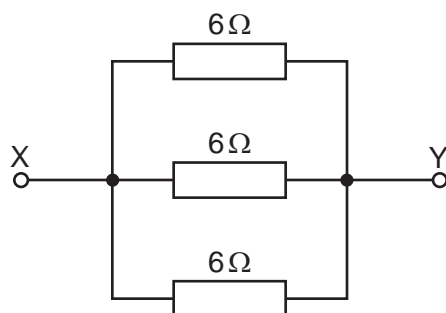

What is the total resistance between points X and Y?

- A**  $0.5\ \Omega$       **B**  $2\ \Omega$       **C**  $6\ \Omega$       **D**  $18\ \Omega$
- 30 P, Q and R are electrical symbols.

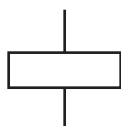

P

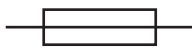

Q

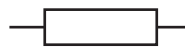

R

What do these symbols represent?

	P	Q	R
A	fuse	resistor	relay coil
B	relay coil	fuse	resistor
C	relay coil	resistor	fuse
D	resistor	fuse	relay coil

- 31 A lamp is rated at  $60\ \text{W}$  on a  $240\ \text{V}$  supply.

What is the current in the lamp when used normally?

- A**  $0.25\ \text{A}$       **B**  $4.0\ \text{A}$       **C**  $60\ \text{A}$       **D**  $180\ \text{A}$
- 32 The cost of electricity is  $16\ \text{c}$  per  $\text{kWh}$ .

What is the cost of using a  $3\ \text{kW}$  heater for 4 hours?

- A**  $\frac{3 \times 4}{16}\ \text{c}$       **B**  $\frac{3 \times 16}{4}\ \text{c}$       **C**  $4 \times 3 \times 16\ \text{c}$       **D**  $4 \times 3 \times 60 \times 16\ \text{c}$

- 33 Two parallel wires carry currents in opposite directions. Three plotting compasses are placed in the positions shown.

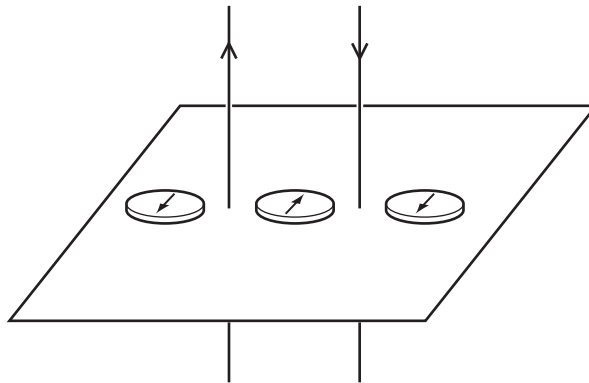

The currents in **both** wires are reversed. How many compass needles change direction?  
(Ignore the effect of the Earth's magnetic field.)

- A 0                      B 1                      C 2                      D 3

- 34 Which single-coil motor has the largest turning effect?

	current in coil / A	number of turns in coil	iron core
<b>A</b>	6	100	no
<b>B</b>	10	200	no
<b>C</b>	6	100	yes
<b>D</b>	10	200	yes

- 35 A magnet is moved towards a coil of insulated wire. A voltmeter connected across the coil shows a positive reading.

What produces a higher reading on the voltmeter?

- A moving the magnet away from the coil at the same speed  
 B moving the magnet away from the coil at a slower speed  
 C moving the magnet towards the coil at a faster speed  
 D moving the magnet towards the coil at a slower speed

- 36 The diagram shows the output of an a.c. generator as displayed on a cathode-ray oscilloscope. The horizontal scale is 5 ms/cm.

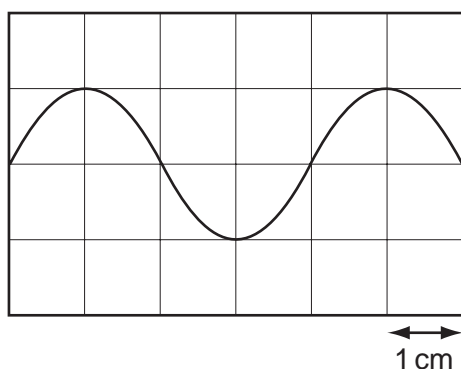

What is the time for one complete rotation of the coil of the generator?

- A 5 ms                      B 10 ms                      C 20 ms                      D 30 ms
- 37 The trace of a waveform is seen on the screen of a cathode-ray oscilloscope.

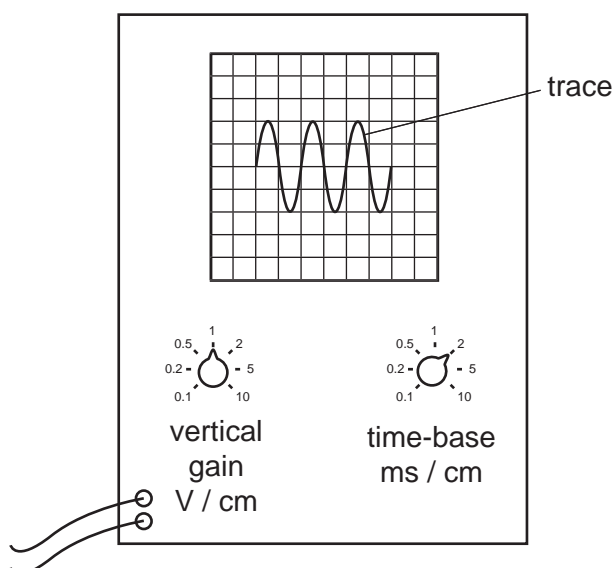

Which statement about the controls is correct?

- A The amplitude of the trace is changed by adjusting the time-base.  
 B The amplitude of the trace is changed by adjusting the vertical gain.  
 C The whole trace is moved to the right by adjusting the time-base.  
 D The whole trace is moved upwards by adjusting the vertical gain.
- 38 How many protons are in the nucleus of an atom of radium,  ${}^{226}_{88}\text{Ra}$  ?

- A 88                      B 138                      C 226                      D 314

- 39 The diagram shows the radioactive emissions that pass through a piece of plastic and a piece of metal of the same thickness.

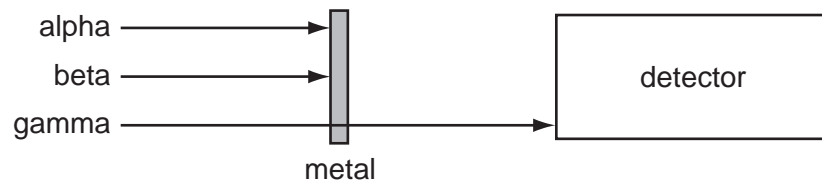
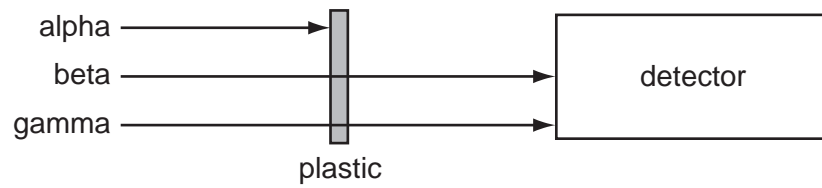

Which types of radioactive emission can distinguish between the plastic and the metal?

- A alpha, beta and gamma
  - B alpha only
  - C beta only
  - D gamma only
- 40 The background count rate in a laboratory is 10 counts/min.
- The measured count rate from a radioactive source is 410 counts/min, which includes the background.
- The half-life of the source is 5 days.
- What is the measured count rate after 15 days?
- A 10 counts/min
  - B 50 counts/min
  - C 60 counts/min
  - D 110 counts/min



**BLANK PAGE**

---

Permission to reproduce items where third-party owned material protected by copyright is included has been sought and cleared where possible. Every reasonable effort has been made by the publisher (UCLES) to trace copyright holders, but if any items requiring clearance have unwittingly been included, the publisher will be pleased to make amends at the earliest possible opportunity.

University of Cambridge International Examinations is part of the Cambridge Assessment Group. Cambridge Assessment is the brand name of University of Cambridge Local Examinations Syndicate (UCLES), which is itself a department of the University of Cambridge.