



UNIVERSITY OF CAMBRIDGE INTERNATIONAL EXAMINATIONS
General Certificate of Education Ordinary Level

PHYSICS

5054/11

Paper 1 Multiple Choice

May/June 2011

1 hour

Additional Materials: Multiple Choice Answer Sheet
Soft clean eraser
Soft pencil (type B or HB is recommended)



READ THESE INSTRUCTIONS FIRST

Write in soft pencil.

Do not use staples, paper clips, highlighters, glue or correction fluid.

Write your name, Centre number and candidate number on the Answer Sheet in the spaces provided unless this has been done for you.

There are **forty** questions on this paper. Answer **all** questions. For each question there are four possible answers **A, B, C** and **D**.

Choose the **one** you consider correct and record your choice in **soft pencil** on the separate Answer Sheet.

Read the instructions on the Answer Sheet very carefully.

Each correct answer will score one mark. A mark will not be deducted for a wrong answer.
Any rough working should be done in this booklet.

This document consists of **15** printed pages and **1** blank page.



- 1 A plumber measures, as **accurately** as possible, the length and internal diameter of a straight copper pipe.

The length is approximately 80 cm and the internal diameter is approximately 2 cm.

What is the best combination of instruments for the plumber to use?

	internal diameter	length
A	rule	rule
B	rule	tape
C	vernier calipers	rule
D	vernier calipers	tape

- 2 What is the correct unit for the quantity shown?

	quantity	unit
A	electromotive force (e.m.f.)	N
B	latent heat	J
C	pressure	kg/m ³
D	weight	kg

- 3 A skydiver falls from rest through the air and reaches terminal velocity.

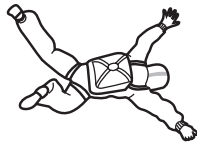

What is the acceleration of the skydiver during his fall?

- A** constant at 0 m/s^2
B constant at 10 m/s^2
C starting at 0 m/s^2 and increasing to 10 m/s^2
D starting at 10 m/s^2 and decreasing to 0 m/s^2

- 4 A car accelerates from traffic lights for 10 s. It stays at a steady speed for 20 s and then brakes to a stop in 3 s.

Which graph shows the journey?

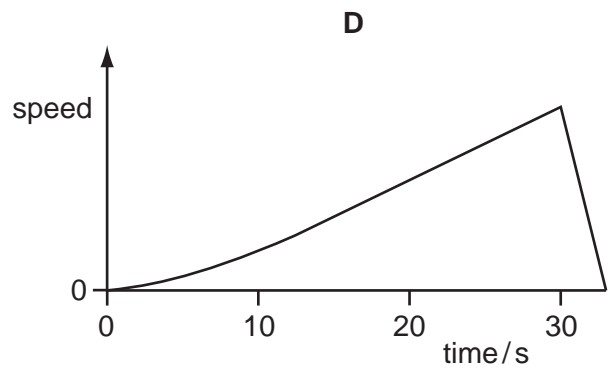
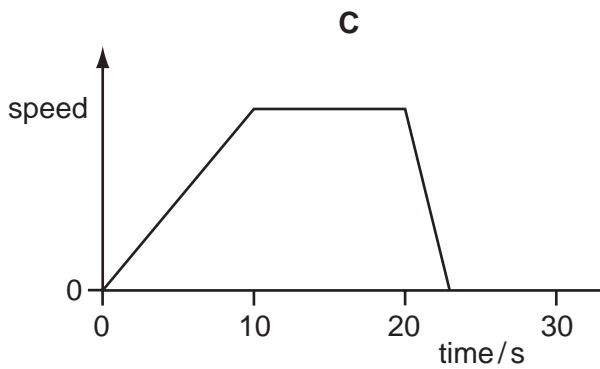
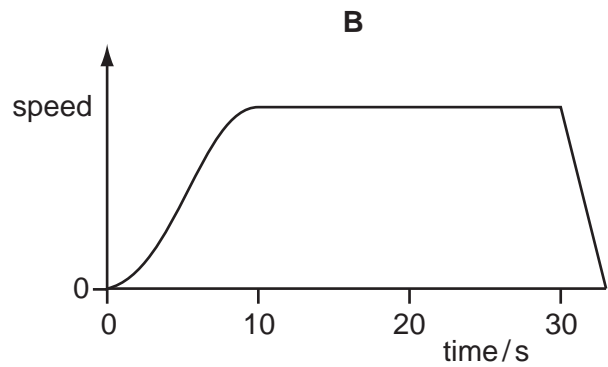
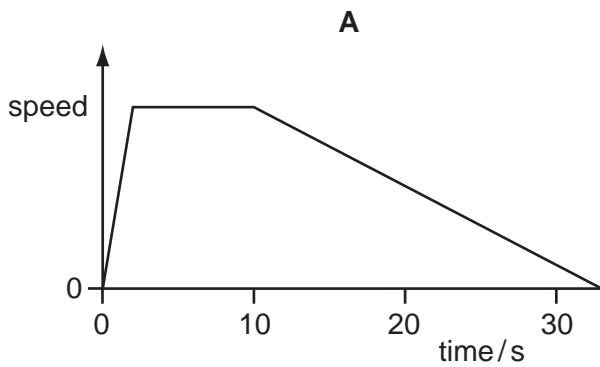

- 5 Which vehicle has an acceleration of 5 m/s^2 ?
- A** a bicycle, when its speed changes from rest to 2.5 m/s in 2 s
 - B** a car, when its speed changes from rest to 15 m/s in 5 s
 - C** a lorry, when its speed changes from rest to 20 m/s in 15 s
 - D** a motorbike, when its speed changes from rest to 50 m/s in 10 s

- 6 A car moves in a circle at constant speed.

What is the direction of the resultant force acting on the car?

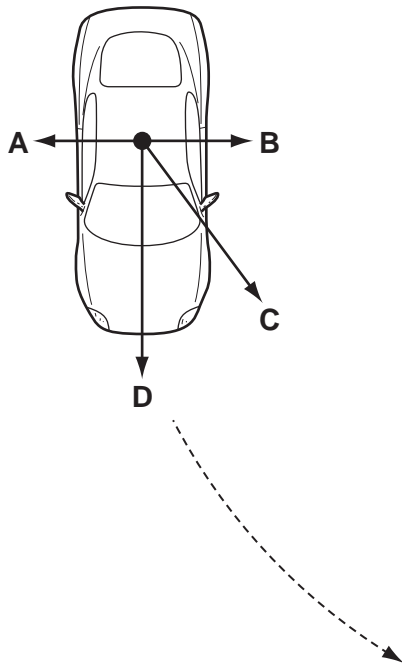

● centre of circle
turned by car

- 7 A student collects stones and finds their density.

Which apparatus is needed to measure the mass and the volume of the stones?

	mass	volume
A	newton meter	measuring cylinder and water
B	newton meter	ruler and calipers
C	top-pan balance	measuring cylinder and water
D	top-pan balance	ruler and calipers

- 8 A uniform beam is balanced at its midpoint. An object is placed on the beam, as shown.

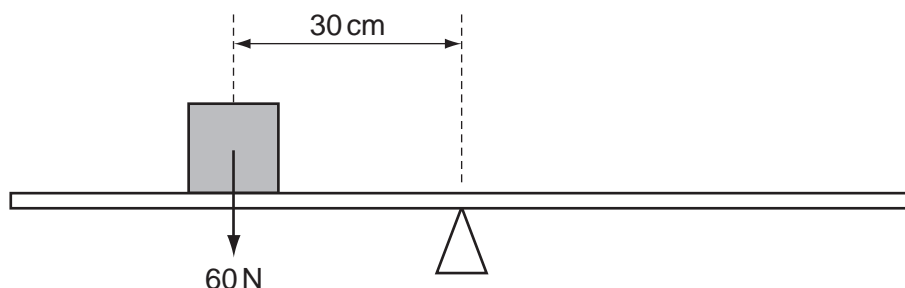

Which force will rebalance the beam?

- A** 30 N acting upwards, 60 cm to the left of the midpoint
B 30 N acting upwards, 60 cm to the right of the midpoint
C 45 N acting downwards, 45 cm to the right of the midpoint
D 90 N acting downwards, 20 cm to the left of the midpoint
- 9 A student finds the centre of mass of a triangular lamina PQR.

He drills a small hole at Q. He suspends the lamina from a pin through the hole at Q so that the lamina swings freely. He then hangs a plumb-line from the pin at Q, as shown. He marks the position of the plumb-line on the lamina.

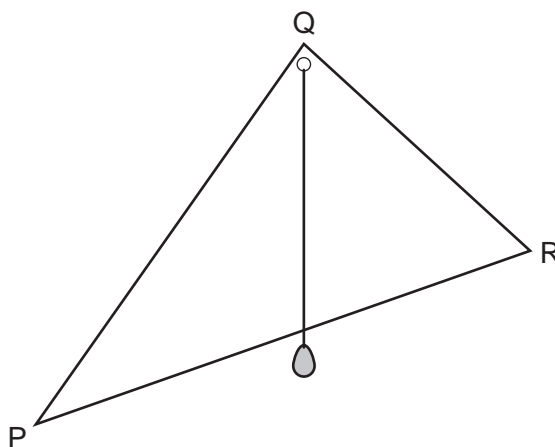

To determine the location of the centre of mass, the student then repeats the experiment but with one change.

What is the change?

- A** He suspends the lamina from the hole at Q, with R on the left and P on the right.
B He suspends the lamina from a pin through a hole at R.
C He uses a heavier weight on the plumb-line.
D He uses a longer plumb-line.

10 The **same** downward force is applied to four objects resting on a horizontal surface.

Which exerts the greatest pressure on the surface?

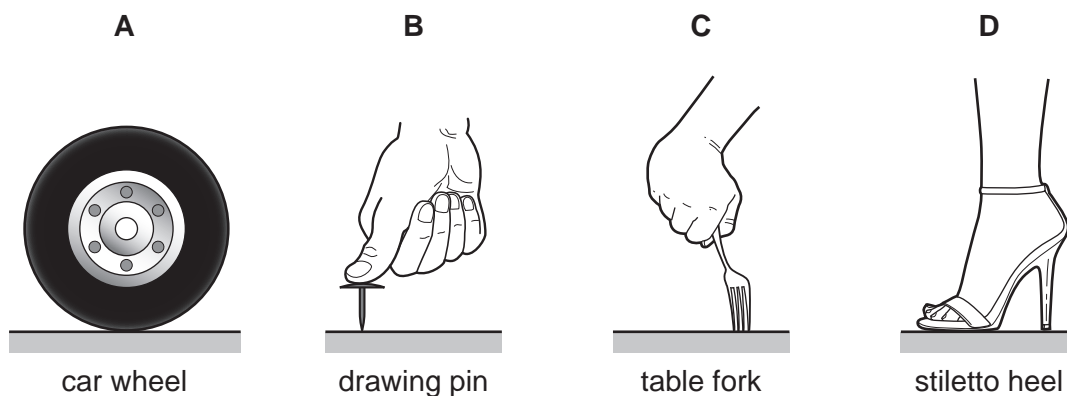

11 Four identical measuring cylinders contain liquid.

Two contain water of density 1000 kg/m^3 .

Two contain paraffin of density 800 kg/m^3 .

Which cylinder has the **least** pressure exerted on its base by the liquid it contains?

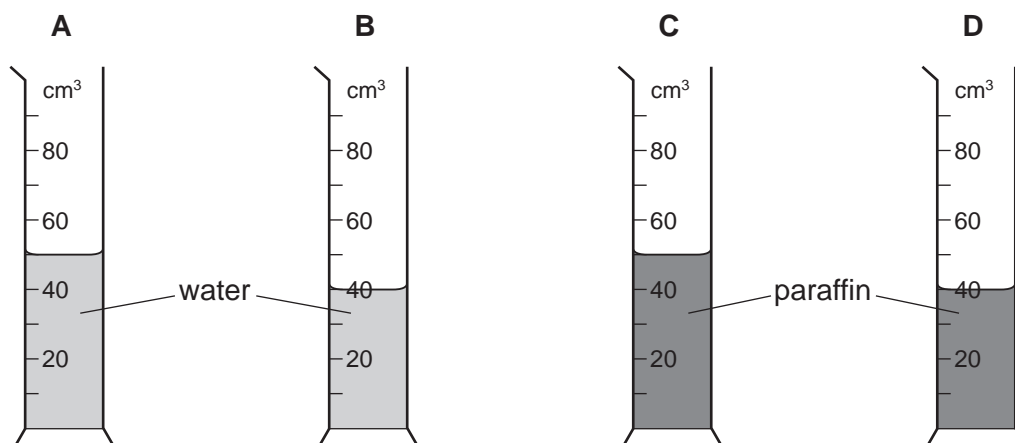

12 The diagram represents parts of a power station.

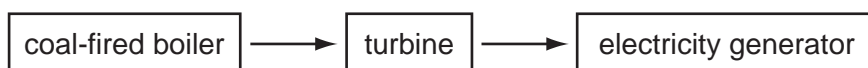

What is the order of the energy changes taking place?

- A chemical → heat → kinetic → electrical
- B chemical → kinetic → heat → electrical
- C heat → chemical → kinetic → electrical
- D kinetic → chemical → heat → electrical

- 13 The centre of the Sun produces large amounts of energy.

What is the source of this energy?

- A chemical reaction
- B nuclear fission
- C nuclear fusion
- D radioactive decay

- 14 A crane lifts a weight of 1000 N through a vertical height of 30 m.

It uses 60 000 J of energy.

What is the efficiency of the crane?

- A 20% B 30% C 50% D 200%

- 15 According to the kinetic theory, matter is made up of very small particles in a constant state of motion.

Which row best describes the particle behaviour in the liquid state?

	forces between particles	motion of particles
A	strong	move randomly at high speed
B	strong	vibrate but are free to move position
C	strong	vibrate to and fro around a fixed position
D	weak	move randomly at high speed

- 16 A balloon filled with air is gently heated.

What happens to the mass and the density of the air inside the balloon?

	mass	density
A	decreases	decreases
B	decreases	stays the same
C	stays the same	decreases
D	stays the same	stays the same

- 17 A certain liquid is used in a liquid-in-glass thermometer. It does not expand uniformly with temperature.

What effect will this have on the scale of the thermometer?

- A It will be non-linear.
 B It will have a small range.
 C The markings will be close together.
 D The markings will be far apart.
- 18 An ice pack is used to cool 0.25 kg of water. The specific heat capacity of water is $4.2 \text{ kJ}/(\text{kg } ^\circ\text{C})$.

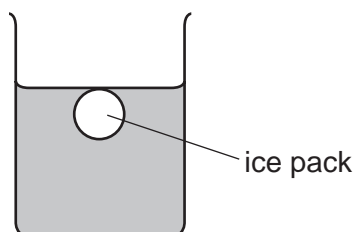

How much thermal energy (heat) must the ice pack extract from the water to reduce the water temperature by 15°C ?

- A 0.070 kJ B 1.1 kJ C 16 kJ D 250 kJ
- 19 Fillings in teeth should be made from a material which
- A does not expand when heated.
 B expands by the same amount as the tooth when heated.
 C expands less than the tooth when heated.
 D expands more than the tooth when heated.

- 20 The displacement-distance and displacement-time graphs are for a water wave in a ripple tank.

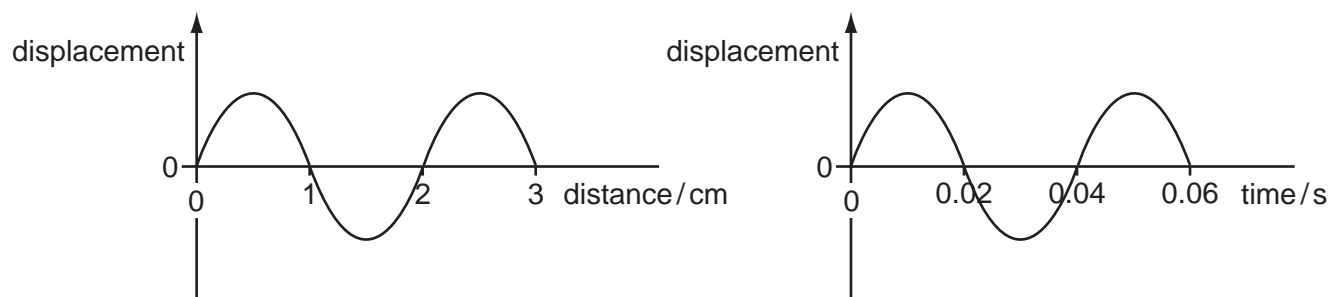

What is the speed of the water wave?

- A 0.02 cm/s B 0.08 cm/s C 25 cm/s D 50 cm/s

21 A ray of light strikes a plane mirror and is reflected.

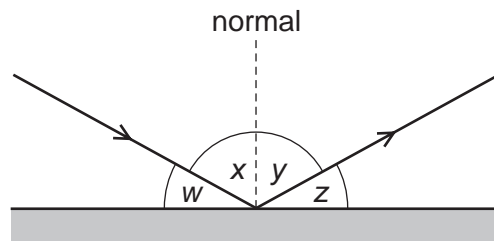

Which pair of angles **must** be equal in value?

- A** w and x **B** w and y **C** x and y **D** x and z

22 In which diagram is the path of the light ray **not** correct?

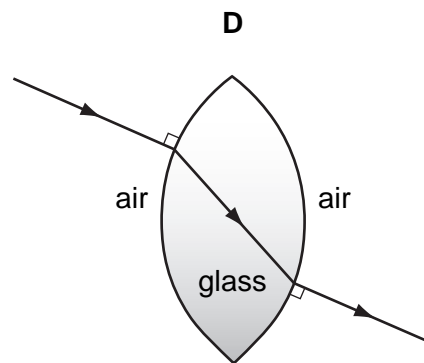
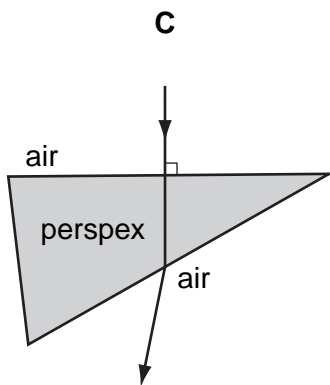
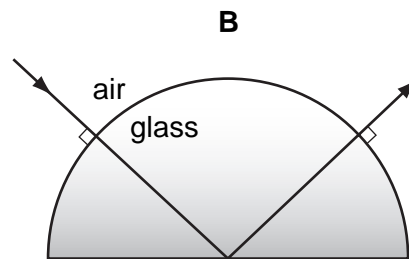
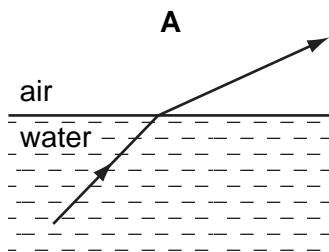

- 23 The ray diagram shows two rays from a point on an object placed in front of a diverging (concave) lens.

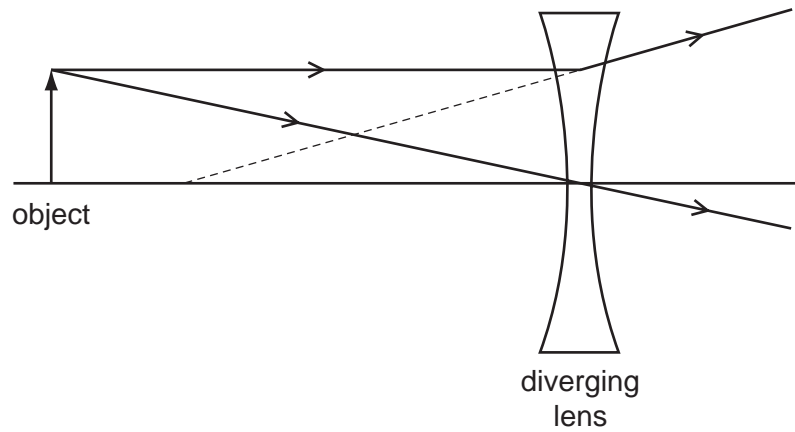

What are the properties of the image produced?

- A real and larger than the object
 - B real and smaller than the object
 - C virtual and larger than the object
 - D virtual and smaller than the object
- 24 Which application may use the part of the electromagnetic spectrum called microwaves?
- A cooking vegetables
 - B detecting small cracks in metals
 - C gaining a sun-tan
 - D lighting a fluorescent tube
- 25 Sound travels at different speeds in air, water and steel.

For these materials, which row is correct?

	sound travels slowest in	sound travels fastest in
A	air	steel
B	air	water
C	steel	air
D	water	air

26 Which list contains an example of a non-magnetic material, a magnetic material and a magnetised material?

- A copper, iron, a compass needle
- B copper, iron, polythene
- C iron, steel, a compass needle
- D iron, steel, polythene

27 To charge an isolated metal sphere by induction, the following four processes are required.

- P The sphere is earthed by touching it.
- Q The earth connection is removed from the sphere.
- R A charged rod is brought close to the sphere.
- S The charged rod is removed.

In which order can these stages be carried out to charge the isolated metal sphere?

- A P → Q → R → S
- B P → R → S → Q
- C R → P → Q → S
- D R → P → S → Q

28 The potential difference (p.d.) across a 10Ω resistor is 5V.

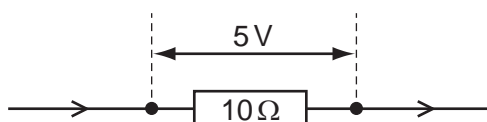

How much charge passes through the 10Ω resistor in 30 seconds?

- A 2 C
- B 15 C
- C 60 C
- D 1500 C

29 Which changes both cause a decrease in the resistance of a copper wire?

	size of wire	temperature of wire
A	decrease in length	lower
B	increase in length	lower
C	decrease in thickness	higher
D	increase in thickness	higher

30 The diagram shows a circuit.

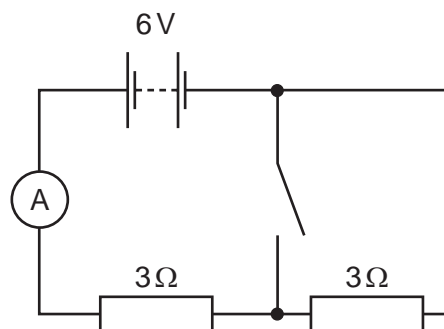

What is the reading on the ammeter when the switch is open, and the reading when it is closed?

	ammeter reading when open / A	ammeter reading when closed / A
A	1	1
B	1	2
C	2	1
D	2	2

31 The diagram shows a circuit.

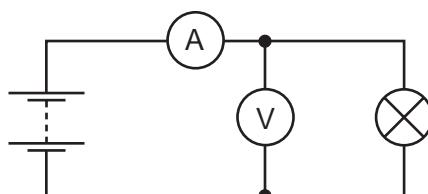

The lamp is a 12W lamp and is working at normal brightness.

What are the readings on the meters?

	voltmeter reading / V	ammeter reading / A
A	6	0.5
B	12	0.5
C	12	1
D	24	2

32 A lamp rated 6V, 2A is switched on for 60s.

How much energy is used?

- A** 0.2J **B** 20J **C** 180J **D** 720J

33 The diagram shows three pairs of parallel wires with the currents in the directions shown.

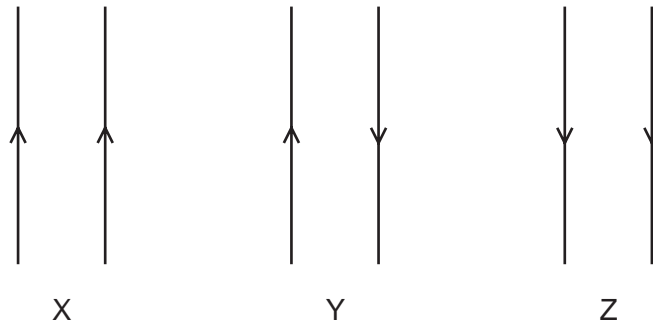

For each pair of wires, what are the forces between the wires?

	X	Y	Z
A	attraction	none	repulsion
B	attraction	repulsion	attraction
C	repulsion	attraction	repulsion
D	repulsion	repulsion	repulsion

34 The coil in an electric motor is wound onto a cylinder.

Why is the cylinder made of soft iron?

- A to deflect the magnetic field away from the coil
- B to increase the current through the coil
- C to increase the strength of the magnetic field through the coil
- D to support the coil and prevent it from collapsing

35 The electromotive force (e.m.f.) induced in a conductor moving at right-angles to a magnetic field does **not** depend upon

- A the length of the conductor.
- B the resistance of the conductor.
- C the speed of the conductor.
- D the strength of the magnetic field.

- 36 The diagram shows part of an a.c. generator when its coil is in a horizontal position.

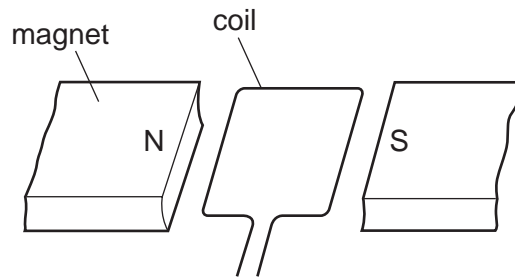

The graph shows the voltage output plotted against time.

Which point on the graph shows when the coil is in a vertical position?

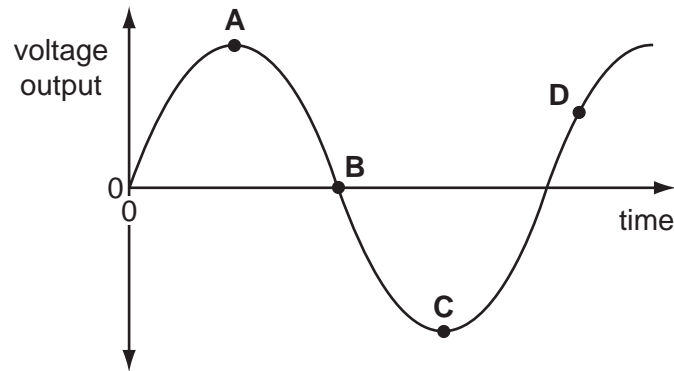

- 37 An alternating voltage of frequency 0.5 Hz is applied to the Y-plates of a cathode-ray oscilloscope (c.r.o.).

The diagram shows the screen of the c.r.o.

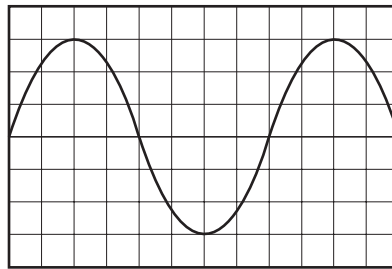

What is the time taken for the spot to cross the screen?

- A** 3 s **B** 6 s **C** 15 s **D** 30 s

- 38 Tritium is a radioactive isotope of hydrogen with a half-life of 12 years.

If a sample starts with 40 million atoms of tritium, how many atoms of tritium will be left after 12 years?

- A 40 million
- B 20 million
- C 10 million
- D 5 million

- 39 A radioactive nuclide ${}_{92}^{238}\text{U}$ decays into thorium by emitting an alpha-particle.

The thorium then decays into protactinium by emitting a beta-particle.

What is the symbol for protactinium?

- A ${}_{90}^{230}\text{Pa}$
- B ${}_{89}^{234}\text{Pa}$
- C ${}_{90}^{234}\text{Pa}$
- D ${}_{91}^{234}\text{Pa}$

- 40 Chlorine exists as two isotopes. One has a nucleon number (mass number) of 35 and the other has a nucleon number (mass number) of 37.

Which table shows the correct numbers of protons and neutrons in the isotopes?

A

	number of protons	number of neutrons
isotope 1	17	18
isotope 2	17	20

B

	number of protons	number of neutrons
isotope 1	18	17
isotope 2	20	17

C

	number of protons	number of neutrons
isotope 1	35	17
isotope 2	37	17

D

	number of protons	number of neutrons
isotope 1	17	35
isotope 2	17	37

BLANK PAGE

Permission to reproduce items where third-party owned material protected by copyright is included has been sought and cleared where possible. Every reasonable effort has been made by the publisher (UCLES) to trace copyright holders, but if any items requiring clearance have unwittingly been included, the publisher will be pleased to make amends at the earliest possible opportunity.

University of Cambridge International Examinations is part of the Cambridge Assessment Group. Cambridge Assessment is the brand name of University of Cambridge Local Examinations Syndicate (UCLES), which is itself a department of the University of Cambridge.