



UNIVERSITY OF CAMBRIDGE INTERNATIONAL EXAMINATIONS
General Certificate of Education Ordinary Level

PHYSICS

5054/13

Paper 1 Multiple Choice

May/June 2010

1 hour

Additional Materials: Multiple Choice Answer Sheet
Soft clean eraser
Soft pencil (type B or HB is recommended)



READ THESE INSTRUCTIONS FIRST

Write in soft pencil.

Do not use staples, paper clips, highlighters, glue or correction fluid.

Write your name, Centre number and candidate number on the Answer Sheet in the spaces provided unless this has been done for you.

There are **forty** questions on this paper. Answer **all** questions. For each question there are four possible answers **A, B, C** and **D**.

Choose the **one** you consider correct and record your choice in **soft pencil** on the separate Answer Sheet.

Read the instructions on the Answer Sheet very carefully.

Each correct answer will score one mark. A mark will not be deducted for a wrong answer.
Any rough working should be done in this booklet.

This document consists of **17** printed pages and **3** blank pages.



1 The following statements are about motion.

- 1 A plane flies due East for 600 km.
- 2 A runner's average speed in a race around a track is 5 m/s.
- 3 A snail crawls at 3 mm/s in a straight line towards a lettuce.
- 4 A tourist travels 500 km on a journey.

Which statements describe vector quantities?

- A** 1 and 2 **B** 1 and 3 **C** 2 and 3 **D** 2 and 4

2 Power is measured in watts.

What is the correct symbol for millions of watts?

- A** mw **B** mW **C** Mw **D** MW

3 Two men jump out of an aeroplane at the same time. One of the men opens his parachute and the other man remains in free-fall.

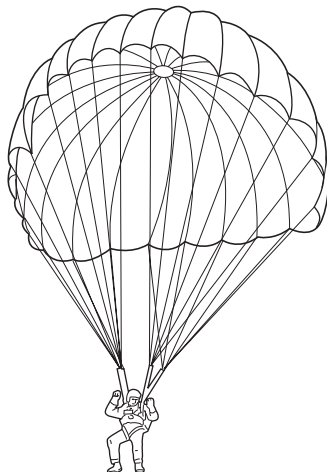

Why is the man in free-fall moving faster than the parachutist?

- A** The man in free-fall experiences greater air resistance.
B The man in free-fall has a greater mass.
C The parachutist experiences greater air resistance.
D The parachutist has not reached terminal velocity.

- 4 A student measures the speed of a trolley. At one instant, the speed of the trolley is 1.0 m/s and two seconds later the speed is 4.0 m/s.

What is the acceleration of the trolley?

- A 1.5 m/s² B 2.0 m/s² C 2.5 m/s² D 5.0 m/s²

- 5 The speed-time graph shows the movement of a car.

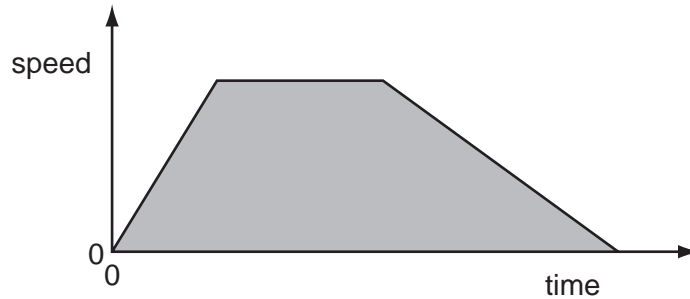

What does the shaded area of the graph represent?

- A the average acceleration of the car
 B the average speed of the car
 C the total distance travelled by the car
 D the total travelling time of the car
- 6 A passenger is sitting in an aeroplane, which takes off and climbs to 10 000 m.
 During this time, what happens to the mass and to the weight of the passenger?

	mass	weight
A	decreases	decreases
B	increases	increases
C	unchanged	decreases
D	unchanged	increases

- 7 A wooden trapdoor is hinged along one side and, when closed, is supported on the other side by a ledge.

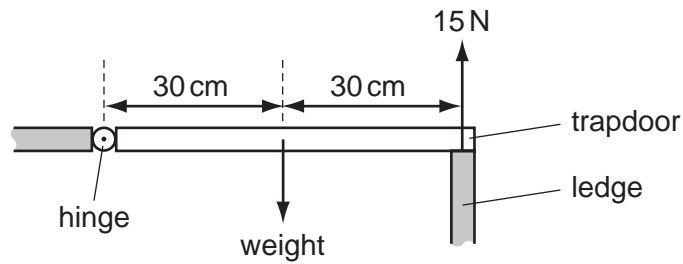

When the trapdoor is closed, the ledge exerts an upward force of 15 N on the trapdoor. The gravitational field strength is 10 N/kg.

What is the mass of the trapdoor?

- A 1.5 kg B 3.0 kg C 30 kg D 150 kg
- 8 The diagram shows an aeroplane turning in a horizontal circle at constant speed.
- In which direction is there a resultant force?

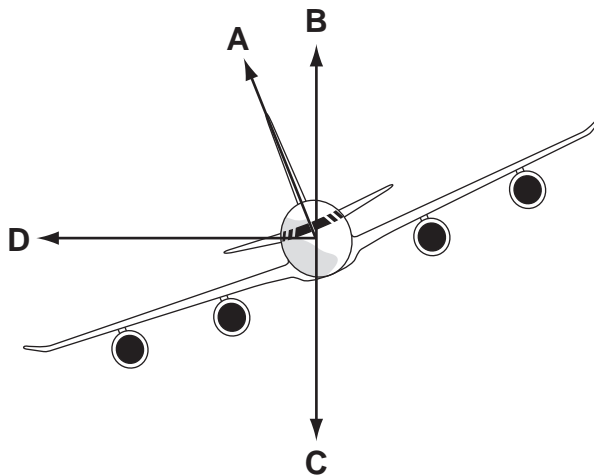

- 9 The diagram shows the levels X and Y in a liquid manometer with the gas tap open.

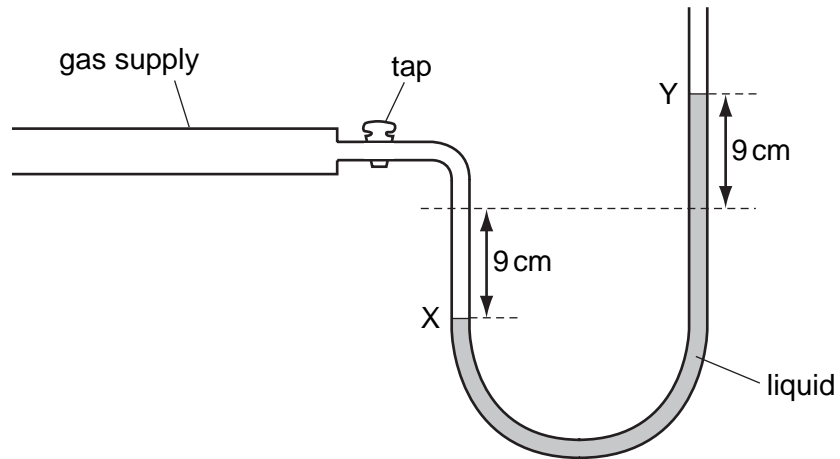

What is the pressure of the gas supply?

- A 18 cm of liquid below atmospheric pressure
 - B 9 cm of liquid below atmospheric pressure
 - C 9 cm of liquid above atmospheric pressure
 - D 18 cm of liquid above atmospheric pressure
- 10 Which part of the graph shows the limit of proportionality for an elastic solid?

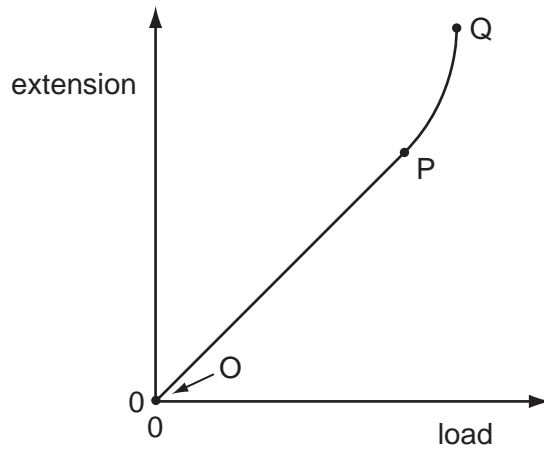

- A O
- B OP
- C P
- D PQ

- 11 Five blocks have the same mass but different base areas. They all rest on a horizontal table.

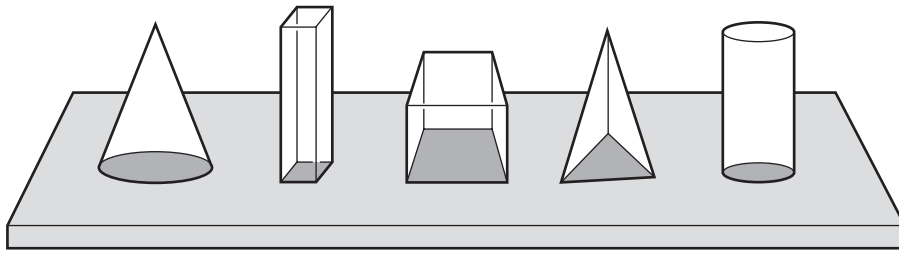

A graph is plotted to show the relationship between the pressure exerted on the table and the base area of the block.

Which graph shows this relationship?

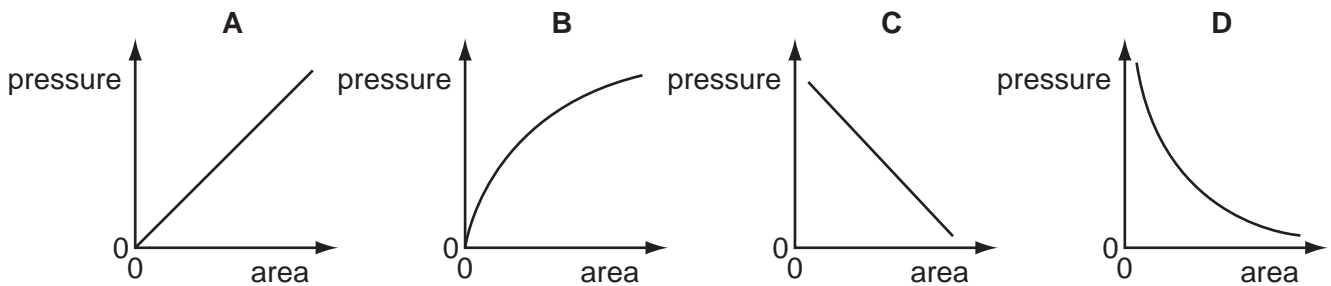

- 12 A small emergency generator supplies 432 000 000 J of electrical energy in twenty-four hours.

What is the average power output of the generator?

- A 5000 W
- B 300 000 W
- C 18 000 000 W
- D 432 000 000 W

- 13 A parachutist has opened his parachute and is falling to Earth at constant speed.

What is the principal energy conversion taking place as he falls?

- A kinetic energy \rightarrow potential energy
- B kinetic energy \rightarrow thermal energy (heat)
- C potential energy \rightarrow kinetic energy
- D potential energy \rightarrow thermal energy (heat)

- 14 An ice-cube has of mass of 7.50 g. The ice-cube is at 0°C.

Heat from the surroundings reaches the ice-cube at an average rate of 1.25 J/s.

How long does it take for all of the ice to melt?
(specific latent heat of fusion of ice = 333 J/g)

- A 35.5 s B 55.5 s C 2000 s D 3120 s

- 15 The liquid in a puddle evaporates and this causes its temperature to change.

How does the temperature of the liquid change and why?

	change	reason
A	decreases	less energetic molecules leave the liquid
B	decreases	more energetic molecules leave the liquid
C	increases	less energetic molecules leave the liquid
D	increases	more energetic molecules leave the liquid

- 16 A bimetallic strip made from brass and iron is used as a thermostat.



When the strip is heated, the brass expands more than the iron.

Which shape will the strip become?

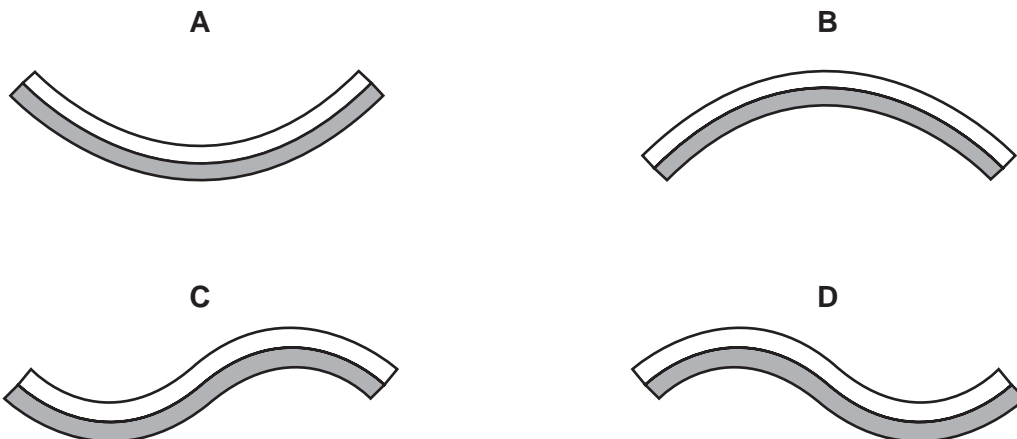

17 When a refrigerator is switched on for the first time, the air surrounding the ice-box is cooled.

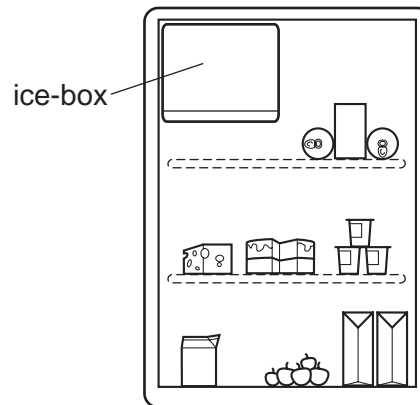

What happens to the density of this air and to its position inside the refrigerator?

	density	position of the air
A	decreases	sinks to the bottom
B	decreases	stays at the top
C	increases	sinks to the bottom
D	increases	stays at the top

18 Convex lenses are used in cameras and as magnifying glasses.

Which types of image are formed?

	type of image in camera	type of image in magnifying glass
A	real	real
B	real	virtual
C	virtual	real
D	virtual	virtual

19 Which diagram shows an example of a longitudinal wave?

A light travelling from a lamp to a screen

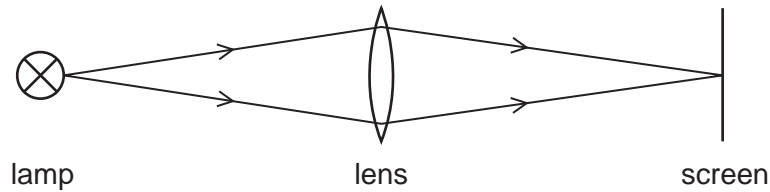

B a spring pushed backwards and forwards



C a spring pushed up and down

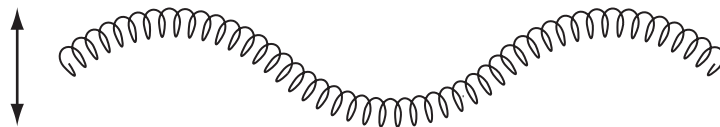

D a water ripple caused by a dipper moving up and down



20 A flash of lightning and the corresponding sound of the thunder are detected 6 s apart. A student calculates that the lightning struck about 1800 m away.

On which assumption is the calculation based?

- A Light reaches us almost instantaneously, but sound travels at 300 m/s.
- B Light travels 300 m/s faster than sound.
- C Light travels 300 times faster than sound.
- D The sound of the thunder was emitted 6 s after the flash.

21 A hospital needs to sterilise medical equipment.

Which electromagnetic waves could be used?

- A infra-red
- B microwaves
- C radiowaves
- D ultraviolet

22 A student holds a sheet of paper with letters on it facing a plane mirror.

The letters on the paper are shown.

TOF

What does the student see in the mirror?

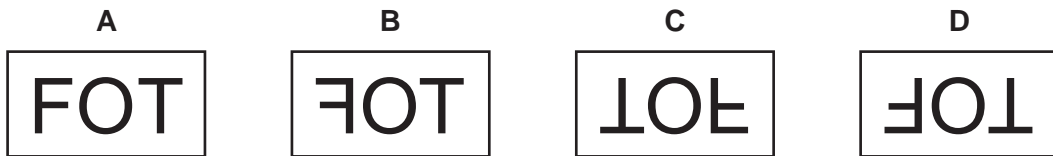

23 A semi-circular block is made from a plastic. A ray of light passes through it at the angles shown.

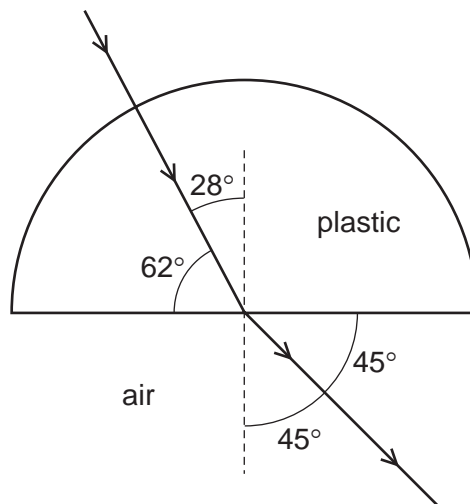

To two decimal places, what is the refractive index of the plastic?

- A 1.25 B 1.41 C 1.51 D 1.61

- 24 Two metal spheres P and Q are mounted on insulating stands and are touching each other. They are uncharged.

A positively-charged metal sphere on an insulating handle is brought close to P but does not touch it. This induces charges on P and Q.

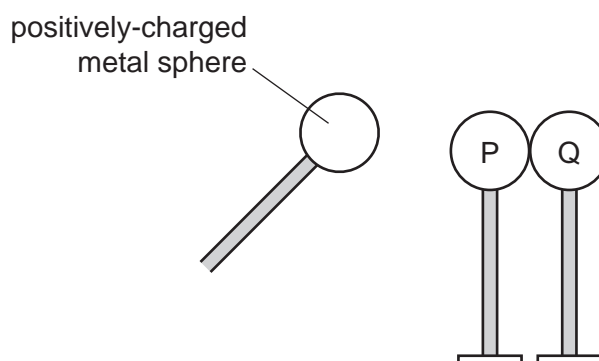

The positively-charged metal sphere is held in this position and sphere Q is moved to the right, away from sphere P.

What are the signs of the induced charges on P and Q and how do the sizes of these charges compare?

	charge on P	charge on Q	sizes of the charges
A	negative	positive	equal
B	negative	positive	unequal
C	positive	negative	equal
D	positive	negative	unequal

- 25 Which properties make materials suitable for use as a core in an electromagnet?

- A** difficult to magnetise and easy to demagnetise
- B** difficult to magnetise and retains magnetic strength
- C** easy to magnetise and retains magnetic strength
- D** easy to magnetise and easy to demagnetise

26 A student tests the circuit of a press-button telephone with a lamp and a battery.

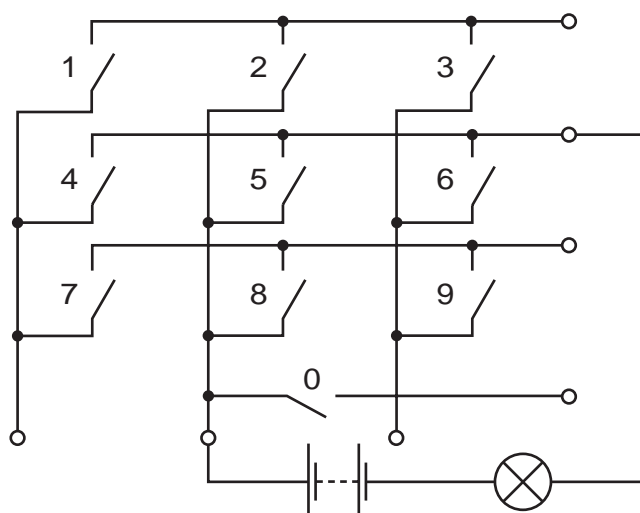

Which single switch can be pressed to make the lamp light?

- A** 0 **B** 1 **C** 5 **D** 6

27 A length of resistance wire is used as a resistor in a simple circuit.

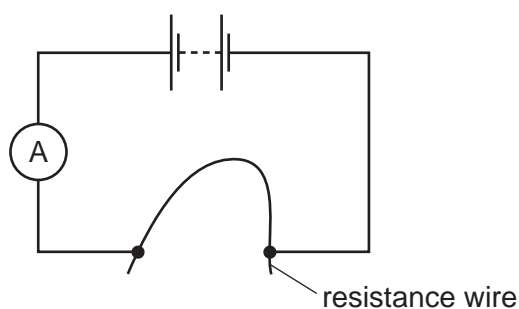

Four separate changes are made to the wire.

Which change will **not** reduce the value of the resistance of the wire?

- A** It is covered in an insulating sleeve.
B Its cross-sectional area is increased.
C Its length is decreased.
D Its temperature is decreased.

28 Which quantity is measured in kilowatt-hours?

- A** charge
B current
C energy
D power

- 29 The metal case of an electric heater is earthed. The plug to the heater contains a 5 A fuse. There is a current of 4 A when the heater works normally.

The cable to the heater becomes so worn that the live wire makes electrical contact with the case.

What happens?

- A The current flows to earth and the fuse is not affected.
 B The fuse melts and switches off the circuit.
 C The metal case becomes live and dangerous.
 D The metal case becomes very hot.
- 30 Sets of voltage-current readings are obtained for different electrical components.

Which set of readings is for a $100\ \Omega$ resistor?

A	voltage/V	-3	-2	-1	0	+1	+2	+3
	current/mA	-30	-15	-5	0	+5	+15	+30
B	voltage/V	-3	-2	-1	0	+1	+2	+3
	current/mA	-30	-20	-10	0	+10	+20	+30
C	voltage/V	-3	-2	-1	0	+1	+2	+3
	current/mA	-60	-40	-20	0	+20	+40	+60
D	voltage/V	-3	-2	-1	0	+1	+2	+3
	current/mA	-60	-45	-30	0	+30	+45	+60

- 31 A 6 V supply is connected in series with an ammeter and a $4\ \Omega$ resistor.

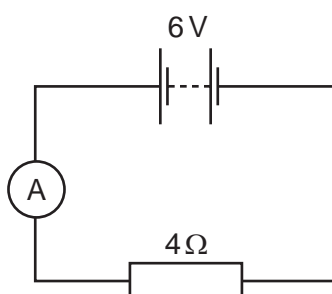

What is the reading on the ammeter?

- A 0.67 A B 1.5 A C 10 A D 24 A

32 A cathode-ray oscilloscope is connected to an a.c. generator.

A wave is seen on the screen of the oscilloscope.

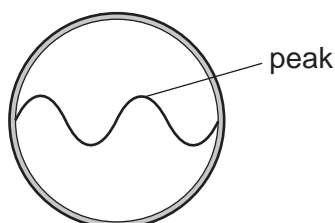

The speed of rotation of the generator is doubled.

What is the effect on the wave?

	number of peaks on the screen	amplitude of wave on the screen
A	doubled	doubled
B	doubled	same
C	same	doubled
D	same	same

33 A long flexible wire is wrapped round two wooden pegs. A large current is passed in the direction shown.

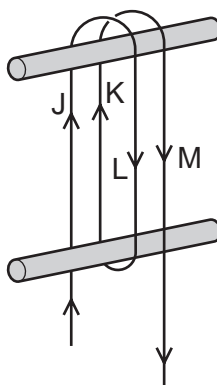

Which two pairs of lengths of wire attract each other?

	first pair	second pair
A	J and K	K and M
B	J and K	L and M
C	J and L	K and M
D	J and L	L and M

34 A capacitor C charges when it is connected to a d.c. power supply.

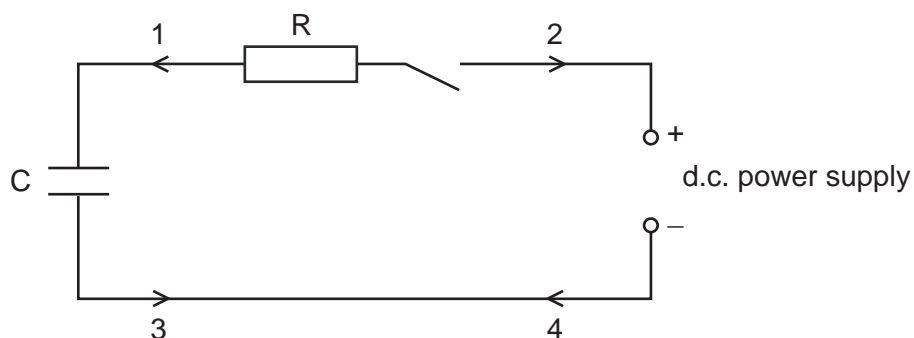

Which arrows show the direction of the conventional current when the capacitor is charging?

- A** 1 and 3 **B** 1 and 4 **C** 2 and 3 **D** 2 and 4

35 A magnet is pushed slowly into a coil and there is a current in the coil in the direction shown.

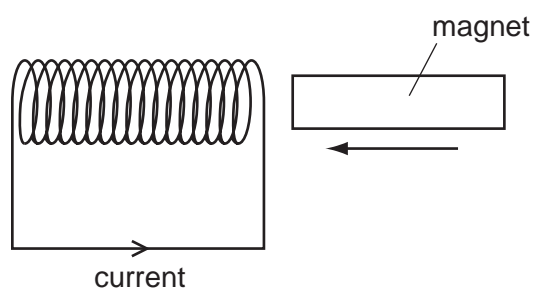

The magnet is then pulled out quickly from the same end of the coil.

What happens to the direction and the size of the current?

	direction	size
A	reversed	decreased
B	reversed	increased
C	unchanged	decreased
D	unchanged	increased

36 The diagram shows a d.c. motor.

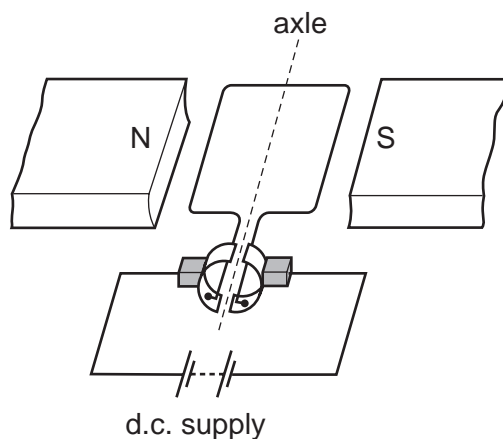

Why is a split-ring commutator used?

- A to change the current direction in the coil as the coil passes the horizontal position
- B to change the current direction in the coil as the coil passes the vertical position
- C to change the current direction in the d.c. supply as the coil passes the horizontal position
- D to change the current direction in the d.c. supply as the coil passes the vertical position

37 Which row is correct for fission and for fusion?

	fission of a nucleus	fusion
A	produces larger nuclei	is the energy source of a star
B	produces larger nuclei	is used to release energy in a power station
C	produces smaller nuclei	is the energy source of a star
D	produces smaller nuclei	is used to release energy in a power station

38 In one radioactive decay, radium (Ra) gives rise to radon (Rn) as shown.

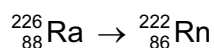

What particle is also produced?

- A an alpha-particle
- B a beta-particle
- C both an alpha-particle and a beta-particle
- D no particle but only gamma-rays

- 39 Proton number is another name for atomic number. Nucleon number is another name for mass number.

What are isotopes?

- A nuclei with different proton numbers and different nucleon numbers
 - B nuclei with different proton numbers and the same nucleon number
 - C nuclei with the same proton number and different nucleon numbers
 - D nuclei with the same proton number and the same nucleon number
- 40 When a sample of a radioactive nuclide decays, the count rate falls from 1200 to 150 in three minutes.

What is the half-life of the radioactive nuclide?

- A 0.75 minutes
- B 1.0 minutes
- C 3.0 minutes
- D 9.0 minutes

BLANK PAGE

Permission to reproduce items where third-party owned material protected by copyright is included has been sought and cleared where possible. Every reasonable effort has been made by the publisher (UCLES) to trace copyright holders, but if any items requiring clearance have unwittingly been included, the publisher will be pleased to make amends at the earliest possible opportunity.

University of Cambridge International Examinations is part of the Cambridge Assessment Group. Cambridge Assessment is the brand name of University of Cambridge Local Examinations Syndicate (UCLES), which is itself a department of the University of Cambridge.