



UNIVERSITY OF CAMBRIDGE INTERNATIONAL EXAMINATIONS  
General Certificate of Education Ordinary Level

CANDIDATE  
NAME

CENTRE  
NUMBER

--	--	--	--	--

CANDIDATE  
NUMBER

--	--	--	--



**HUMAN AND SOCIAL BIOLOGY**

**5096/22**

Paper 2

**October/November 2010**

**2 hours**

Candidates answer on the Question Paper.

No Additional Materials are required.

**READ THESE INSTRUCTIONS FIRST**

Write your Centre number, candidate number and name on all the work you hand in.  
Write in dark blue or black pen.  
You may use a pencil for any diagrams, graphs or rough working.  
Do not use staples, paper clips, highlighters, glue or correction fluid.  
**DO NOT WRITE IN ANY BARCODES.**

**Section A**

Answer **all** questions.  
Write your answers in the spaces provided on the Question Paper.  
You are advised to spend no longer than 1 hour on Section A.

**Section B**

Answer **all** the questions, including questions 8, 9 and 10 **Either** or 10 **Or**.  
Write your answers in the spaces provided on the Question Paper.  
Write an **E** (for Either) or an **O** (for Or) next to the number 10 in the  
Examiner's grid to indicate which question you have answered.

The number of marks is given in brackets [ ] at the end of each question  
or part question.

For Examiner's Use	
1	
2	
3	
4	
5	
6	
7	
<b>Section A sub-total</b>	
8	
9	
10	
<b>Total</b>	

This document consists of **15** printed pages and **1** blank page.



Section A

Answer **all** questions in this section.

Write your answers in the spaces provided.

For  
Examiner's  
Use

- 1 Fig. 1.1 represents several different types of molecules in solution, separated by a membrane.

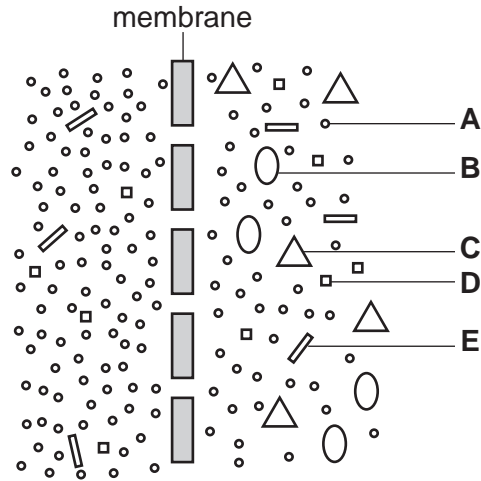

Fig.1.1

- (a) State which letter represents a water molecule. .... [1]  
(b) State the type of membrane shown in Fig. 1.1. .... [1]  
(c) Explain the processes by which molecules move through the membrane.

.....  
.....  
.....  
.....  
.....  
.....  
.....  
.....  
.....  
.....  
..... [6]

Fig. 1.2 shows what happens during filtration in the glomerulus of a kidney.

For  
Examiner's  
Use

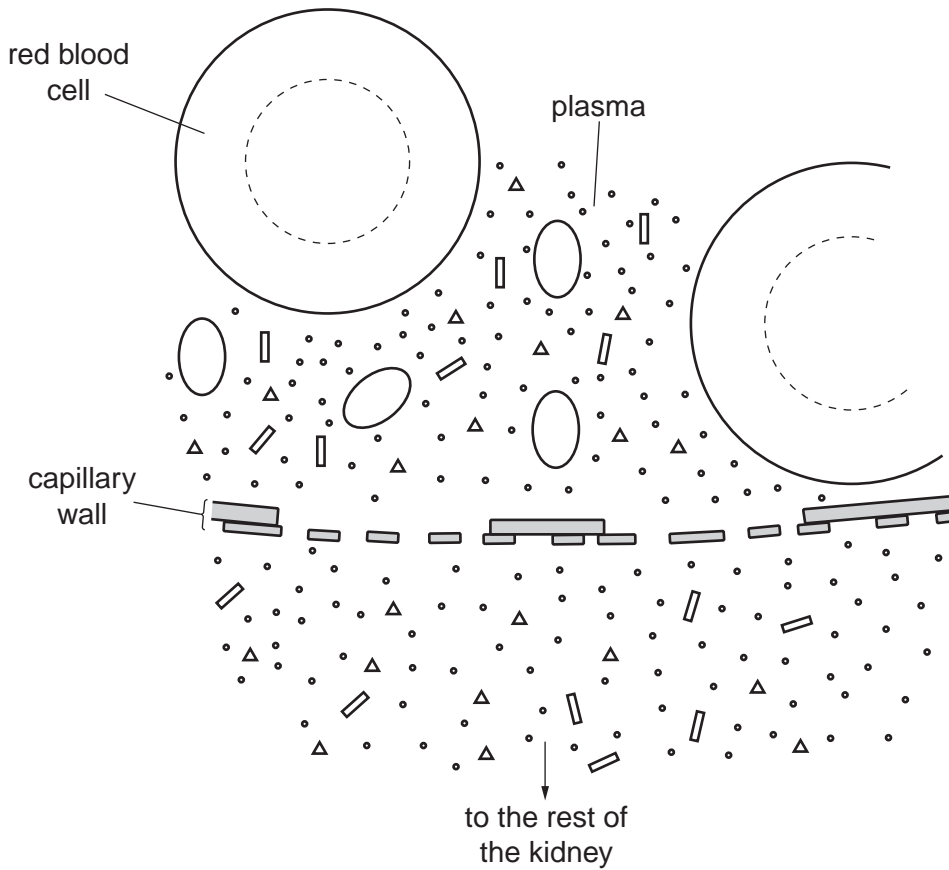

Fig. 1.2

(d) Name the molecules that pass out of the blood plasma.

.....

.....

.....

.....

..... [4]

(e) Explain how filtration differs from the processes explained in (c).

.....

.....

.....

.....

..... [3]

(f) Explain what happens to molecules in the filtrate before urine leaves the kidney.

For  
Examiner's  
Use

.....

.....

.....

.....

.....

.....

.....

.....

.....

.....

..... [5]

[Total: 20]

2 Fig. 2.1 shows a person's alimentary canal.

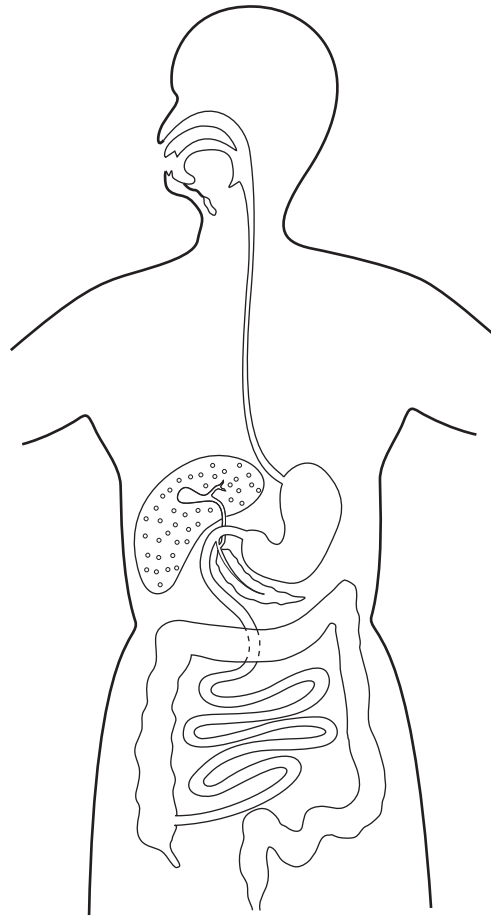

**Fig. 2.1**

- (a) On Fig. 2.1, draw in and label the diaphragm. [1]
- (b) Using a line labelled **X**, show where fat is emulsified. [1]
- (c) Describe the pathway taken by a digested fat molecule from the intestines to the heart.

.....

.....

.....

..... [3]

[Total: 5]

- 3 Fig. 3.1 shows a human forearm and the muscles that bring about its movement.

For  
Examiner's  
Use

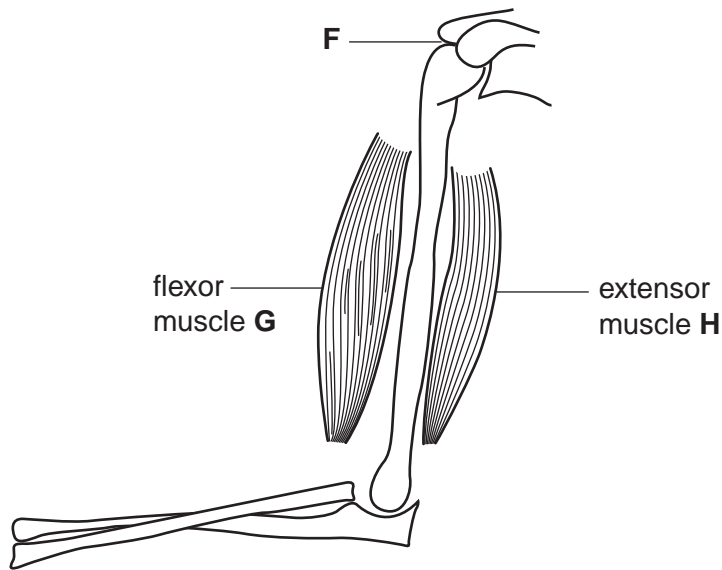
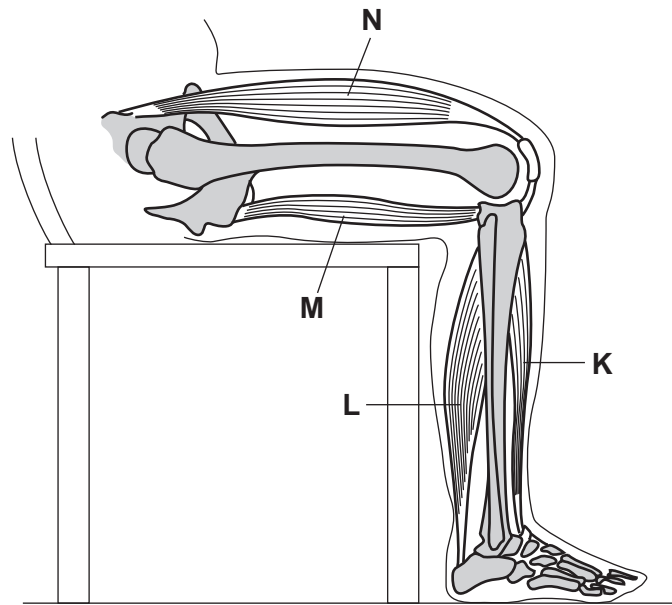

Fig. 3.1

- (a) Identify the type of joint found at **F**. ..... [1]
- (b) Draw, on Fig. 3.1, tendons to show
- (i) the insertion of muscle **G**,
  - (ii) the origin of muscle **H**. [2]

(c) Fig. 3.2 shows the leg muscles of a person sitting on a chair.

For  
Examiner's  
Use



**Fig. 3.2**

Using the information in Fig. 3.2, suggest which of the muscles, **K**, **L**, **M** or **N** is the flexor for the knee joint. Explain your answer.

*muscle* ..... [1]

*explanation* ..... [1]

[Total: 5]

- 4 Fig. 4.1 shows a human sperm cell.

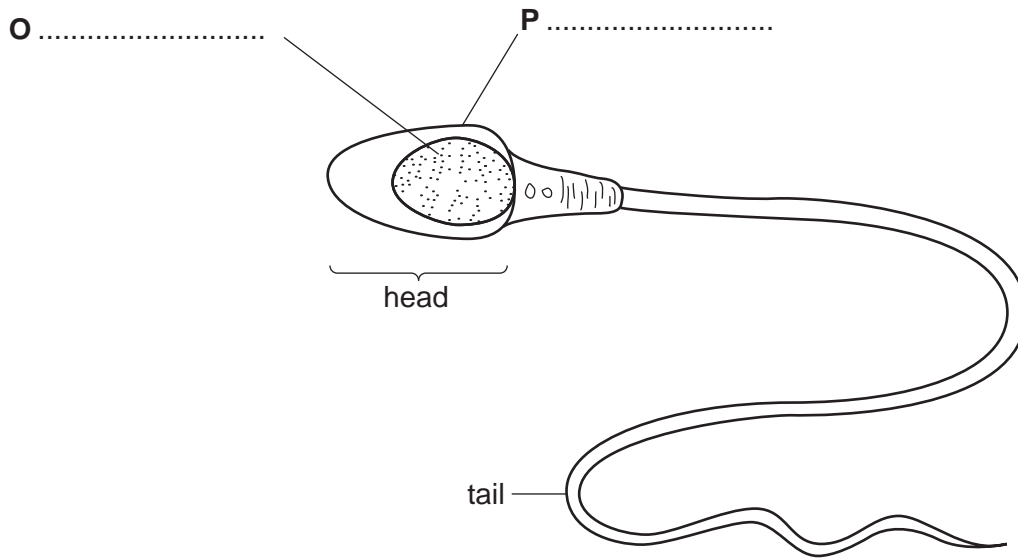

**Fig. 4.1**

- (a) On Fig. 4.1, label the structures **O** and **P**. [2]

- (b) Explain what is meant by the term *chromosome*.

.....  
 ..... [2]

- (c) Using the symbols **X** and **Y**, draw a diagram to show how sex is inherited in humans.

[3]

[Total: 7]



5 The concentration of nitrate ions in the soil was measured before, during and after the growing of a crop. The results are shown in Fig. 5.1.

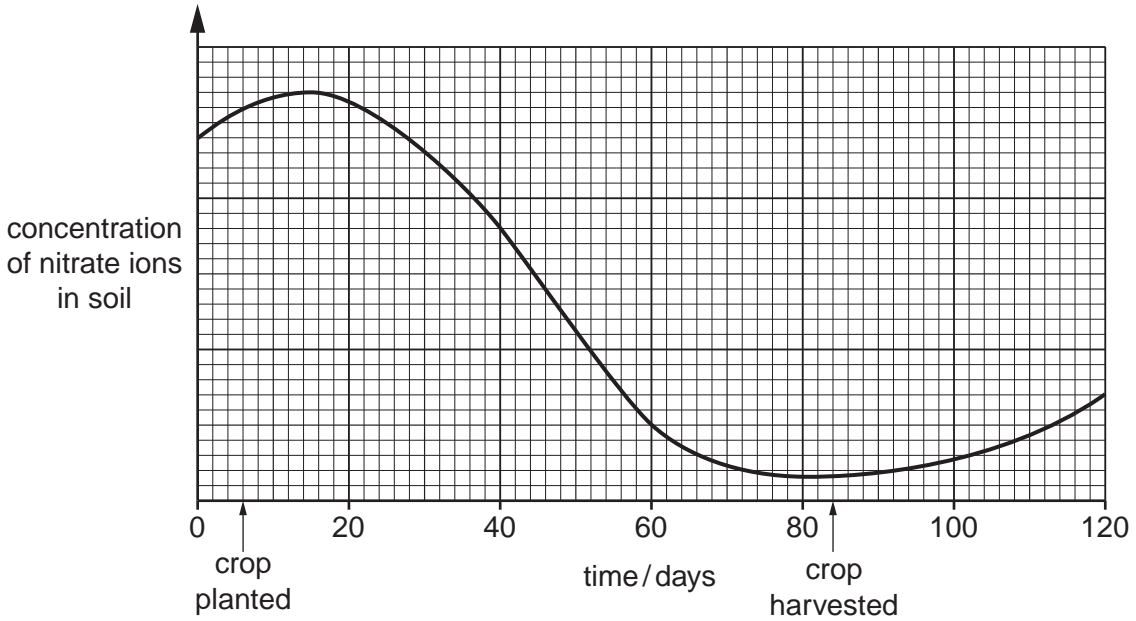

Fig. 5.1

(a) State the name of the nutrient cycle in which nitrate ions are involved.

..... [1]

(b) Outline how nitrate ions are used by the crop plant.

.....  
..... [2]

(c) Explain what is happening in the soil between time 0 and the planting of the crop to increase the concentration of nitrate ions in the soil.

.....  
.....  
.....  
.....  
.....  
.....  
.....  
.....  
.....  
..... [4]

[Total: 7]

6 The diets of two twelve-year-old girls from two countries in different parts of the world were analysed. The results are shown in Fig. 6.1.



Fig. 6.1

(a) Using information from Fig. 6.1, complete the table to compare the diet for the girl in country Q with that of the girl in country R. In each box, write *more* or *less* or *the same*.

	meat, eggs, fish	cereals	dairy products	sugars, sweets	vegetables, fruit
diet for girl in country Q					

[1]

(b) Most of the daily energy intake is provided by carbohydrates and fats. Select **one** of the food groups from Fig. 6.1 that would provide a good source of

(i) carbohydrates, .....

(ii) fats. .... [2]

(c) Suggest why the girl from country Q is more likely than the girl from country R to suffer from

(i) poor wound healing (scurvy),  
 .....  
 .....  
 ..... [2]

(ii) constipation.  
 .....  
 .....  
 ..... [3]

[Total: 8]

7 Fig. 7.1 shows a neurone.

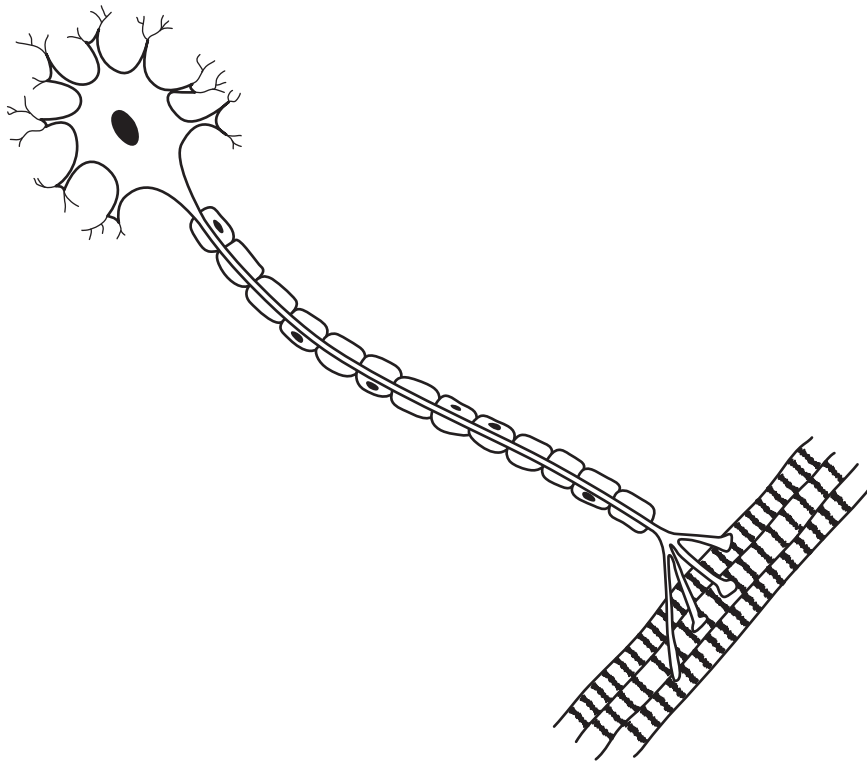

Fig. 7.1

(a) State the difference between a neurone and a nerve.

.....  
..... [1]

(b) State which type of neurone is shown in Fig. 7.1 and explain your answer.

*type of neurone* .....

*explanation* .....

..... [2]

[Total: 3]

**Section B**

Answer **all** questions, including questions 8, 9 and 10 **Either** or 10 **Or**.

For  
Examiner's  
Use

Write your answers in the spaces provided.

**8 (a)** Describe the characteristics of

**(i)** viruses,

.....  
.....  
..... [2]

**(ii)** bacteria,

.....  
.....  
..... [2]

**(iii)** fungi.

.....  
.....  
..... [2]

**(b)** Describe the life cycle of the housefly and explain how it can be responsible for the spread of disease.

.....  
.....  
.....  
.....  
.....  
.....  
.....  
.....  
.....  
.....  
.....  
.....  
.....  
.....  
.....  
.....  
.....  
.....  
.....  
.....  
.....  
.....  
.....  
..... [9]







**BLANK PAGE**

---

Permission to reproduce items where third-party owned material protected by copyright is included has been sought and cleared where possible. Every reasonable effort has been made by the publisher (UCLES) to trace copyright holders, but if any items requiring clearance have unwittingly been included, the publisher will be pleased to make amends at the earliest possible opportunity.

University of Cambridge International Examinations is part of the Cambridge Assessment Group. Cambridge Assessment is the brand name of University of Cambridge Local Examinations Syndicate (UCLES), which is itself a department of the University of Cambridge.