

CHEMISTRY

5070/11

Paper 1 Multiple Choice

October/November 2014

1 hour

Additional Materials: Multiple Choice Answer Sheet
 Soft clean eraser
 Soft pencil (type B or HB recommended)



READ THESE INSTRUCTIONS FIRST

Write in soft pencil.
Do not use staples, paper clips, glue or correction fluid.
Write your name, Centre number and candidate number on the Answer Sheet in the spaces provided unless this has been done for you.
DO NOT WRITE IN ANY BARCODES.

There are **forty** questions on this paper. Answer **all** questions. For each question there are four possible answers **A, B, C** and **D**.
Choose the **one** you consider correct and record your choice in **soft pencil** on the separate Answer Sheet.

Read the instructions on the Answer Sheet very carefully.

Each correct answer will score one mark. A mark will not be deducted for a wrong answer.
Any rough working should be done in this booklet.
A copy of the Periodic Table is printed on page 16.
Electronic calculators may be used.

This document consists of **14** printed pages and **2** blank pages.

- 1 Calcium carbonate reacts with hydrochloric acid, producing carbon dioxide gas.



The rate of this reaction can be measured using the apparatus shown.

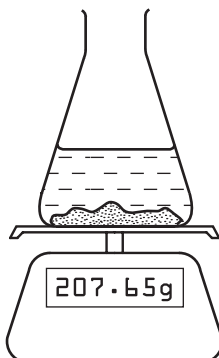

Which additional piece of apparatus is also required?

- A a burette
 - B a clock
 - C a gas syringe
 - D a thermometer
- 2 Which compound when in aqueous solution will produce a red/brown precipitate on the addition of an aqueous solution of Fe^{3+} ions?
- A hydrogen chloride
 - B sodium chloride
 - C sodium hydroxide
 - D sulfur trioxide
- 3 What is the correct sequence for obtaining pure salt from a mixture of sand and salt?
- A add water, evaporate
 - B add water, filter
 - C add water, filter, evaporate
 - D filter, add water, evaporate

4 The diagram shows the structure of which element in Period 3?

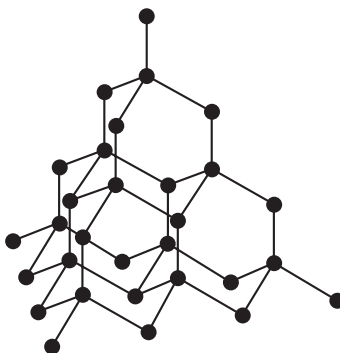

- A aluminium
- B magnesium
- C silicon
- D sodium

5 The table contains information on the structure of four particles.

particle	proton number	number of protons	number of neutrons	number of electrons
Mg	12	12	W	12
Mg ²⁺	12	12	12	X
F	Y	9	10	9
F ⁻	9	9	10	Z

What are the values of W, X, Y and Z in the table above?

	W	X	Y	Z
A	10	12	9	10
B	12	10	9	10
C	12	10	10	9
D	12	12	10	9

6 Which statement describes ionic bonding?

- A a lattice of ions in a sea of electrons
- B electrostatic attraction between oppositely charged ions
- C the sharing of electrons between atoms to gain a noble gas configuration
- D the transfer of electrons from atoms of a non-metal to the atoms of a metal

7 The experiment shown is used to test potassium bromide crystals.

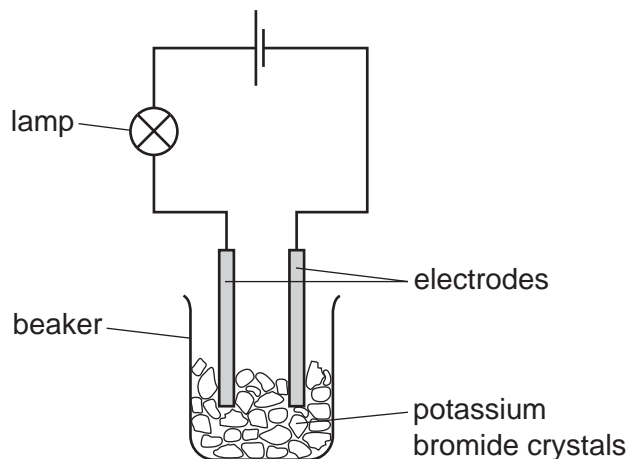

The lamp does not light.

Distilled water is then added to the beaker and the lamp lights.

Which statement explains these results?

- A Electrons are free to move in the solution when potassium bromide dissolves.
 - B Metal ions are free to move when potassium bromide melts.
 - C Metal ions are free to move when potassium reacts with water.
 - D Oppositely charged ions are free to move in the solution when potassium bromide dissolves.
- 8 Why does ammonia gas diffuse faster than hydrogen chloride gas?
- A Ammonia has a higher boiling point than hydrogen chloride.
 - B Ammonia is a base, hydrogen chloride is an acid.
 - C The ammonia molecule contains more atoms than a hydrogen chloride molecule.
 - D The relative molecular mass of ammonia is smaller than that of hydrogen chloride.
- 9 Which molecule has only four electrons involved in covalent bonds?
- A H_2S
 - B CO_2
 - C Cl_2
 - D N_2

10 A volume of ethane, C_2H_6 , at r.t.p. has a mass of 20 g.

What is the mass of an equal volume of propene, C_3H_6 , at r.t.p.?

- A 20g B 21g C 28g D 42g

11 Which element requires the largest number of electrons for one mole of the metal to be formed from its aqueous ions during electrolysis?

- A aluminium
B calcium
C copper
D sodium

12 Which changes are observed during the electrolysis of aqueous copper(II) sulfate using copper electrodes?

- 1 A pink solid is deposited on the negative electrode.
- 2 Bubbles form on the positive electrode.
- 3 The colour of the solution does not change.

- A 1 and 2 only B 1 and 3 only C 2 and 3 only D 1, 2 and 3

13 Analysis of a sample of an oxide of nitrogen gave the following data.

- percentage by mass of nitrogen 47%
- percentage by mass of oxygen 53%

What is the empirical formula of this oxide?

[A_r : N, 14; O, 16]

- A NO B NO_2 C N_2O D N_2O_3

14 Petroleum is a mixture of hydrocarbons which can be separated into fractions by fractional distillation.

Which row shows the fractions in order of decreasing boiling point?

	highest b.p. → lowest b.p.			
A	diesel	paraffin	naphtha	petrol
B	paraffin	naphtha	petrol	diesel
C	naphtha	petrol	diesel	paraffin
D	petrol	naphtha	paraffin	diesel

15 Which is **not** true about the process of photosynthesis?

- A Carbon dioxide and water react in a 1 : 1 molar ratio.
- B Glucose is produced and can be used as a source of energy.
- C Oxygen is produced.
- D The reaction is exothermic.

16 The equation shows the reaction for the manufacture of ammonia.

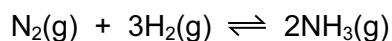

Which change will decrease the activation energy of the reaction?

- A addition of a catalyst
 - B decrease in temperature
 - C increase in concentration
 - D increase in pressure
- 17 Which ionic equation represents a redox reaction?

- A $\text{Ag}^+ + \text{Cl}^- \rightarrow \text{AgCl}$
- B $\text{Ba}^{2+} + \text{SO}_4^{2-} \rightarrow \text{BaSO}_4$
- C $\text{H}^+ + \text{OH}^- \rightarrow \text{H}_2\text{O}$
- D $\text{Zn} + \text{Cu}^{2+} \rightarrow \text{Zn}^{2+} + \text{Cu}$

18 The equation shows the reaction for the formation of sulfur trioxide using a catalyst.

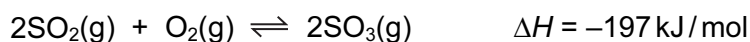

Which change in reaction conditions would produce more sulfur trioxide?

- A adding more catalyst
- B decreasing the pressure
- C increasing the temperature
- D removing some sulfur trioxide

- 19 To which substance is dilute sulfuric acid added to prepare lead(II) sulfate?
- A aqueous lead(II) nitrate
 - B lead foil
 - C powdered lead(II) carbonate
 - D powdered lead(II) oxide
- 20 Which metal can react with water at r.t.p.?
- A calcium
 - B copper
 - C lead
 - D zinc
- 21 Which statement about amphoteric oxides is **not** correct?
- A They dissolve in water.
 - B They are formed only by metals.
 - C They react with aqueous sodium hydroxide to give salts.
 - D They react with aqueous acids to give salts.
- 22 Which statement explains why the chemical properties of sodium and potassium are similar?
- A They are in the same group of the Periodic Table.
 - B They are in the same period of the Periodic Table.
 - C They are soft and can be cut with a knife.
 - D They have similar melting points.

23 The diagram shows an outline of part of the Periodic Table.

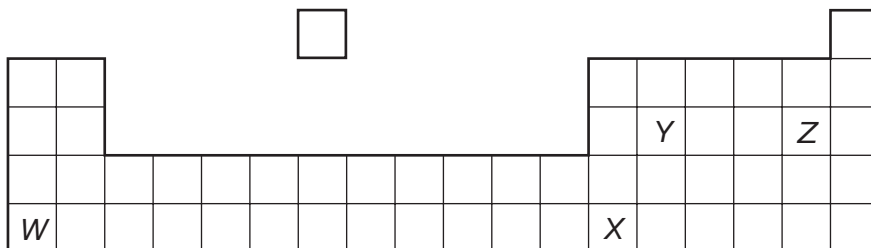

Which statement is **not** correct?

- A The melting point of *W* is lower than that of *Z*.
- B *W* and *Z* could react together and form a compound, *WZ*.
- C *X* could form an oxide, X_2O_3 .
- D *Y* could form an oxide, YO_2 .

24 The diagram shows apparatus that can be used to extract aluminium.

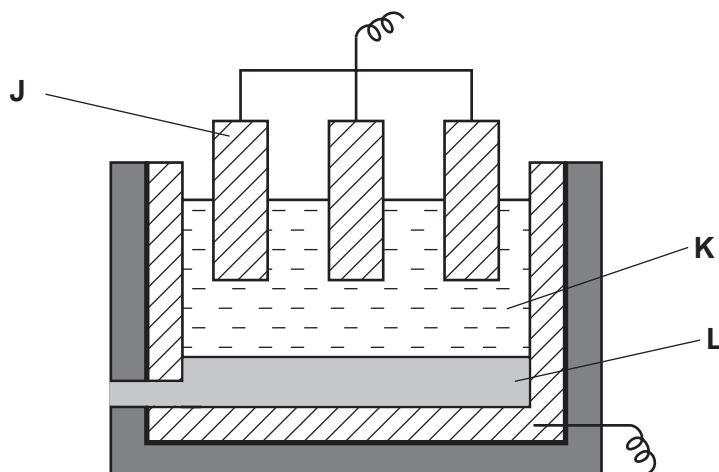

What are **J**, **K** and **L**?

	J	K	L
A	negative electrode	aluminium oxide + cryolite	aluminium
B	negative electrode	cryolite	aluminium oxide
C	positive electrode	aluminium oxide	cryolite
D	positive electrode	aluminium oxide + cryolite	aluminium

25 Sulfur is burnt in air.

Which statement about this reaction is correct?

- A The gas formed turns aqueous potassium dichromate(VI) from green to orange.
- B The product is used as a food preservative.
- C The reaction is endothermic.
- D The reaction is reversible.

26 A gas **G**

- 1 has no smell,
- 2 is not poisonous,
- 3 reacts with hydrogen at high temperature and pressure.

What is gas **G**?

- A carbon monoxide
- B helium
- C nitrogen
- D chlorine

27 Which method of water purification can be used to obtain drinkable water from seawater?

- A chlorination
- B desalination
- C filtration
- D sedimentation

28 Which atmospheric pollutant is produced by bacterial decay of vegetable matter?

- A carbon monoxide
- B methane
- C ozone
- D sulfur dioxide

- 29 Substance **P** reacts with dilute hydrochloric acid to produce a gas. This gas reduces substance **Q**.

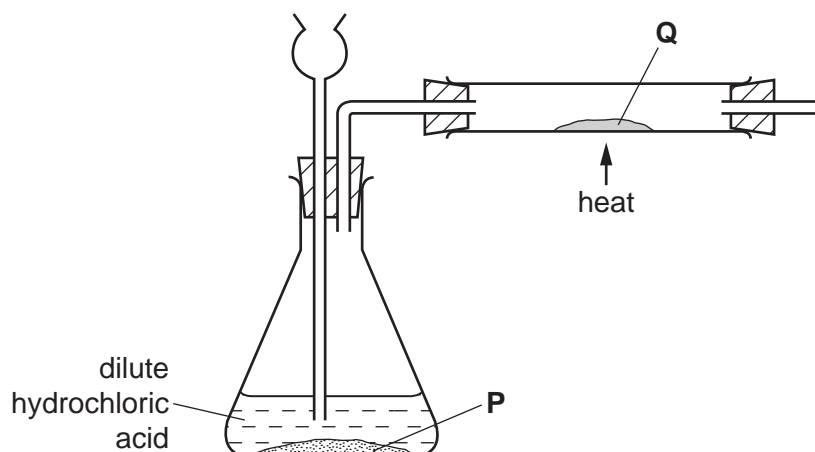

What are substances **P** and **Q**?

	P	Q
A	copper	copper(II) oxide
B	lead	lead(II) oxide
C	magnesium	zinc oxide
D	zinc	copper(II) oxide

- 30 Which two statements about alloys are correct?

- 1 Alloys are formed by mixing two metals.
- 2 Alloys do **not** conduct electricity.
- 3 Atoms in an alloy must all be the same size.
- 4 In an alloy there is metallic bonding.

- A** 1 and 2 **B** 1 and 4 **C** 2 and 3 **D** 3 and 4

- 31 A powdered mixture of metals contains aluminium, calcium, silver and iron. Excess hydrochloric acid is added until no more mixture dissolves.

What is the undissolved residue?

- A** aluminium
B calcium
C iron
D silver

32 Iron rusts when exposed to oxygen in the presence of water.

Which method will **not** slow down the rate of rusting of an iron roof?

- A attaching strips of copper to it
- B coating it with plastic
- C galvanising it with zinc
- D painting it

33 A compound has the following structure.

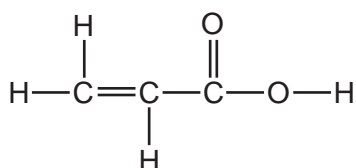

Which reactions will occur with this compound?

- 1 Bromine water will decolourise.
- 2 It will react with an alcohol to form an ester.
- 3 It will react with sodium metal.

- A 1 only B 1 and 2 only C 1, 2 and 3 D 2 and 3 only

34 In the Periodic Table, how many periods are needed to accommodate the elements of atomic numbers 1-18?

- A 2 B 3 C 4 D 8

35 A compound **X** has the molecular formula $\text{C}_4\text{H}_8\text{O}_2$. It reacts with calcium carbonate to give carbon dioxide.

What is **X**?

- A $\text{HCO}_2\text{C}_3\text{H}_7$
- B $\text{CH}_3\text{CO}_2\text{C}_2\text{H}_5$
- C $\text{C}_2\text{H}_5\text{CO}_2\text{CH}_3$
- D $\text{C}_3\text{H}_7\text{CO}_2\text{H}$

36 Methane is the first member of the alkane series of hydrocarbons. The second member is ethane.

Which statements about ethane are correct?

- 1 Ethane has the formula C_2H_4 .
- 2 Ethane has a higher boiling point than that of methane.
- 3 Ethane has the same molecular formula as methane.
- 4 Ethane has chemical properties very similar to those of methane.

A 1, 2 and 3 **B** 1 and 4 **C** 2 and 4 **D** 3 only

37 Which alkane, when any one hydrogen atom is substituted by a chlorine atom, will **not** produce isomers?

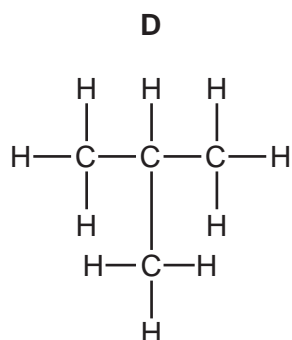
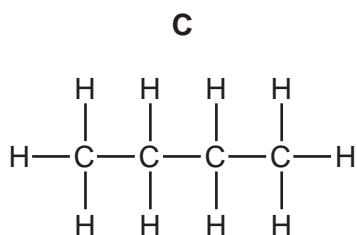
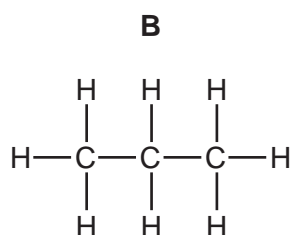
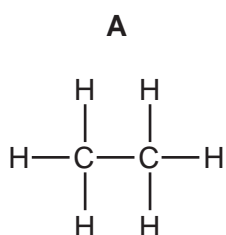

38 When ethanol reacts with ethanoic acid, the ester ethyl ethanoate is formed.

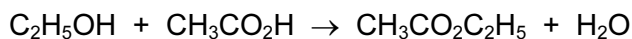

What is the formula of the ester formed when methanol reacts with butanoic acid, $C_3H_7CO_2H$?

- A** $C_2H_5CO_2C_2H_5$
- B** $C_3H_7CO_2C_2H_5$
- C** $CH_3CO_2C_3H_7$
- D** $C_3H_7CO_2CH_3$

39 The table gives some statements about some macromolecules.

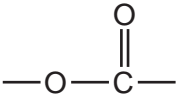
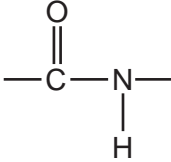
1	fats contain the linkage 	proteins contain the linkage 
2	poly(ethene) is made by addition polymerisation	<i>Terylene</i> is made by condensation polymerisation
3	starch can be hydrolysed to produce sugars	proteins can be hydrolysed to produce amino acids
4	<i>Terylene</i> is a naturally occurring polymer	nylon is a man-made polymer

Which pairs of statements are correct?

- A** 1 and 2 only **B** 2 and 3 only **C** 3 and 4 **D** 1, 2 and 3

40 Which of these compounds could react together to form a polymer?

- 1 $\text{H}_2\text{N}(\text{CH}_2)_6\text{NH}_2$
- 2 $\text{CH}_3(\text{CH}_2)_4\text{COOH}$
- 3 $\text{HOOC}(\text{CH}_2)_4\text{COOH}$
- 4 $\text{H}_2\text{N}(\text{CH}_2)_6\text{CH}_3$

- A** 1 and 2 **B** 1 and 3 **C** 2 and 4 **D** 3 and 4

