

**CHEMISTRY**

**5070/12**

Paper 1 Multiple Choice

**May/June 2014**

**1 hour**

Additional Materials: Multiple Choice Answer Sheet  
Soft clean eraser  
Soft pencil (type B or HB is recommended)

\* 4 9 7 6 8 3 1 4 9 3 \*

**READ THESE INSTRUCTIONS FIRST**

Write in soft pencil.

Do not use staples, paper clips, glue or correction fluid.

Write your name, Centre number and candidate number on the Answer Sheet in the spaces provided unless this has been done for you.

**DO NOT WRITE IN ANY BARCODES.**

There are **forty** questions on this paper. Answer **all** questions. For each question there are four possible answers **A, B, C** and **D**.

Choose the **one** you consider correct and record your choice in **soft pencil** on the separate Answer Sheet.

**Read the instructions on the Answer Sheet very carefully.**

Each correct answer will score one mark. A mark will not be deducted for a wrong answer.

Any rough working should be done in this booklet.

A copy of the Periodic Table is printed on page 16.

Electronic calculators may be used.

This document consists of **15** printed pages and **1** blank page.

- 1 Which process is suitable for obtaining the water from an aqueous solution of sugar?
- A crystallisation  
 B distillation  
 C filtration  
 D use of a separating funnel

- 2 Sulfur dioxide and oxygen react together.



Which change(s) will increase both the rate of reaction and the equilibrium concentration of  $\text{SO}_3$ ?

- 1 adding a catalyst  
 2 increasing temperature  
 3 increasing pressure

- A 1 only      B 2      C 1 and 3      D 3 only

- 3 The scheme shows a sequence of reactions starting from compound Y.

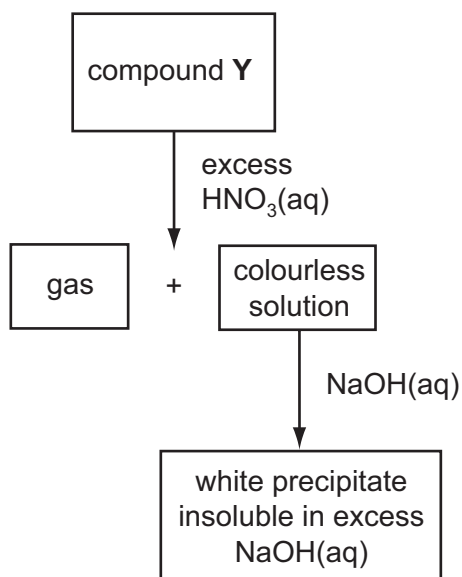

What could the compound Y be?

- A aluminium sulfate  
 B calcium carbonate  
 C copper(II) carbonate  
 D zinc carbonate

- 4 The apparatus shown can be used to find the rate of some chemical reactions.

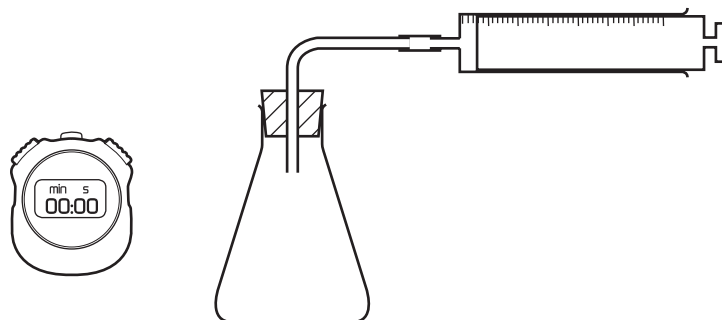

The rate of which reaction can be followed using this apparatus?

- A  $\text{AgNO}_3 + \text{KI}$   
 B  $\text{Mg} + \text{HCl}$   
 C  $\text{NaOH} + \text{CuSO}_4$   
 D  $\text{NaOH} + \text{HCl}$
- 5 Crude oil is fractionally distilled in a fractionating column. The positions at which fractions X and Y are collected are shown.

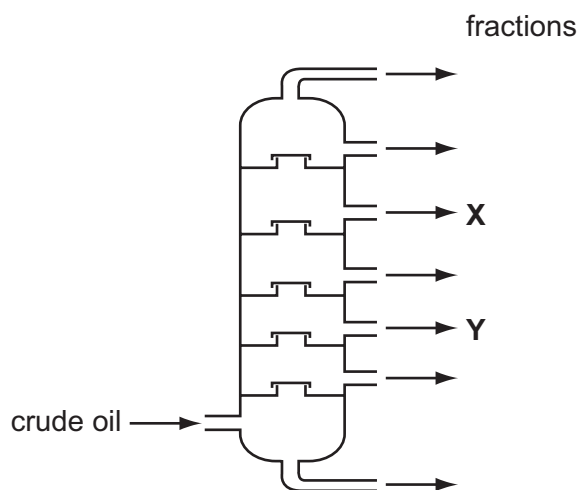

Which statement is correct?

- A The temperature increases up the column.  
 B X condenses at a lower temperature than Y.  
 C X has a higher boiling point than Y.  
 D X has longer chain molecules than Y.

- 6 An ion  $X^+$  has 23 nucleons and 10 electrons.

What does the nucleus of  $X$  contain?

	protons	neutrons
<b>A</b>	9	14
<b>B</b>	10	13
<b>C</b>	11	12
<b>D</b>	13	10

- 7 Which element exists as a macromolecule?

- A** carbon  
**B** hydrogen  
**C** oxygen  
**D** sodium

- 8 Which substance can conduct electricity by the movement of ions?

- A** copper  
**B** graphite  
**C** mercury  
**D** sodium chloride

- 9 The diagram shows the molecule ethyl propanoate.

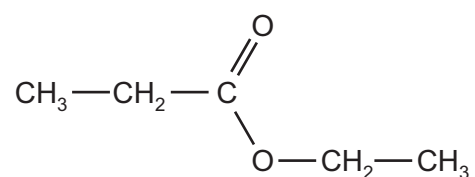

Consider **all** the electrons in a molecule of ethyl propanoate.

How many electrons **not** involved in bonding are there in the molecule?

- A** 8                      **B** 10                      **C** 18                      **D** 22

10 Sodium and magnesium are next to each other in the Periodic Table.

	melting point /°C	boiling point /°C
Na	98	883
Mg	649	1103

Which statement explains the differences in the melting and boiling points of these elements?

- A Na and Mg have different types of bonding.
  - B The electrostatic forces of attraction are stronger in Mg.
  - C The ionic bonds in Mg are stronger than those in Na.
  - D The Mg atoms are larger than the Na atoms.
- 11 Sulfuric acid and potassium hydroxide can react together to form potassium hydrogensulfate,  $\text{KHSO}_4$ , and water only.

Which amounts of the reactants are required?

- A equal masses of sulfuric acid and potassium hydroxide
  - B equal numbers of moles of sulfuric acid and potassium hydroxide
  - C 1 mol of sulfuric acid to 2 mol of potassium hydroxide
  - D 2 mol of sulfuric acid to 1 mol of potassium hydroxide
- 12 The diagram shows the structures of the atoms of elements *L* and *M*.

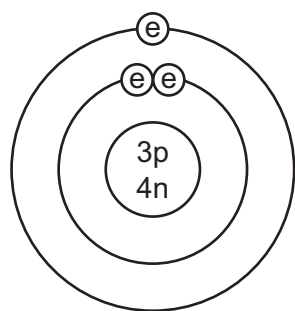

*L*

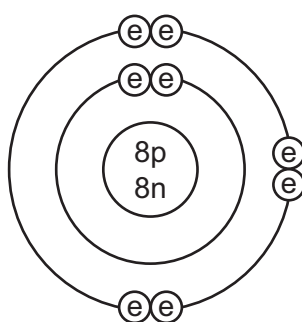

*M*

p = proton  
n = neutron  
e = electron

The elements combine to form a compound.

What is the mass of one mole of this compound?

- A 11g
- B 12g
- C 23g
- D 30g

13 A concentrated aqueous solution of sodium chloride is electrolysed.

What are the equations for the reactions taking place at the cathode (negative electrode) and anode (positive electrode)?

	cathode (-ve)	anode (+ve)
<b>A</b>	$2\text{H}^+ + 2\text{e}^- \rightarrow \text{H}_2$	$2\text{Cl}^- \rightarrow \text{Cl}_2 + 2\text{e}^-$
<b>B</b>	$2\text{H}^+ + 2\text{e}^- \rightarrow \text{H}_2$	$4\text{OH}^- \rightarrow \text{O}_2 + 2\text{H}_2\text{O} + 4\text{e}^-$
<b>C</b>	$\text{Na}^+ + \text{e}^- \rightarrow \text{Na}$	$2\text{Cl}^- \rightarrow \text{Cl}_2 + 2\text{e}^-$
<b>D</b>	$\text{Na}^+ + \text{e}^- \rightarrow \text{Na}$	$4\text{OH}^- \rightarrow \text{O}_2 + 2\text{H}_2\text{O} + 4\text{e}^-$

14 What is observed during the electrolysis of aqueous copper(II) sulfate using carbon electrodes?

- A** A pink solid is deposited on the anode.
- B** Bubbles form on the negative electrode.
- C** The colour of the solution fades.
- D** The negative electrode becomes smaller.

- 15 Nitrogen monoxide is an atmospheric pollutant that is formed in car engines by between nitrogen and oxygen.

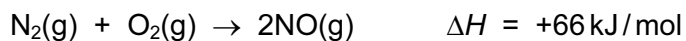

Which diagram represents the energy profile for this reaction?

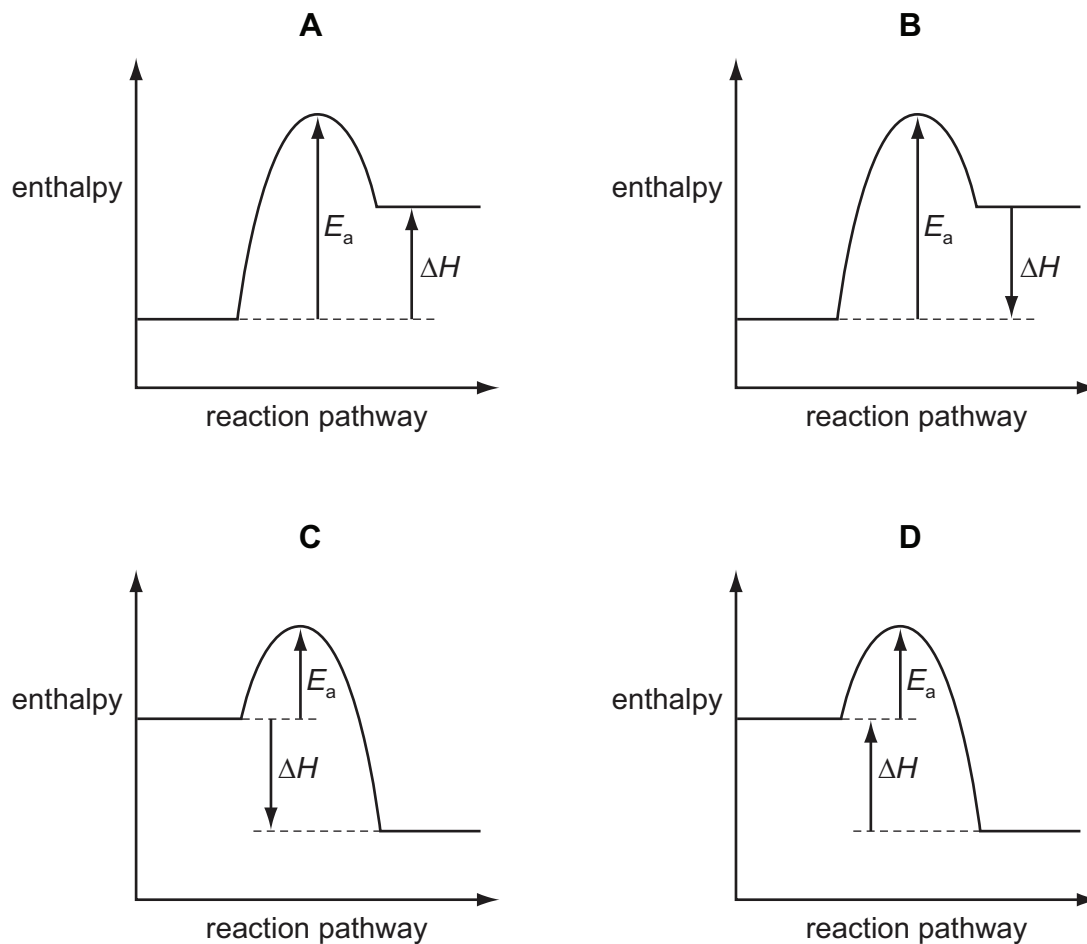

- 16 Which substance does **not** react with hydrochloric acid?

- A zinc carbonate
- B zinc hydroxide
- C zinc metal
- D zinc nitrate

- 17 The table shows the energy released by the complete combustion of some compounds.

compound	formula	$M_r$	$\Delta H$ in kJ/mol
benzene	$C_6H_6$	78	-3270
heptane	$C_7H_{16}$	100	-4800
octane	$C_8H_{18}$	114	-5510
propane	$C_3H_8$	44	-2200

Which fuel releases the least energy when 1 g of the compound is completely burned?

- A benzene  
 B heptane  
 C octane  
 D propane
- 18 In which circuit does the bulb light?

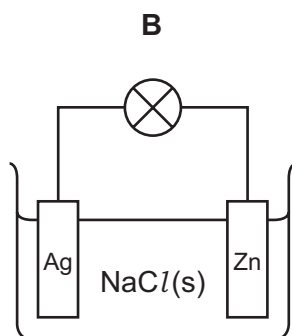
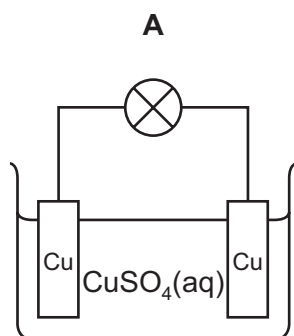

key

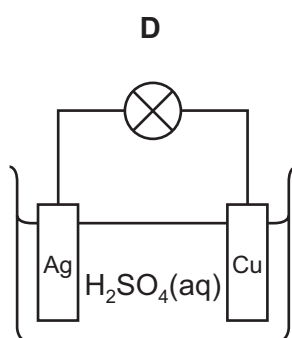
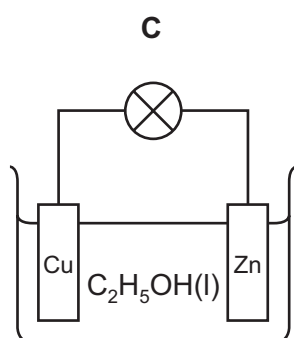
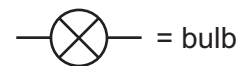



- 19 Ammonia is made by a reversible reaction between nitrogen and hydrogen.

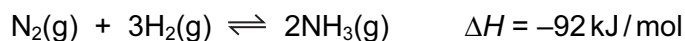

What is the effect of increasing the pressure in this process?

- A Less heat is produced.  
 B More ammonia is formed.  
 C More nitrogen is present at equilibrium.  
 D The reaction slows down.
- 20 Which change involves reduction?
- A calcium carbonate to calcium oxide  
 B copper to brass  
 C ethene to poly(ethene)  
 D sand to silicon
- 21 Samples of three oxides, **X**, **Y** and **Z**, were added separately to dilute hydrochloric acid and to dilute sodium hydroxide.

**X** and **Y** react with dilute hydrochloric acid but **Z** does not react.

**Y** and **Z** react with aqueous sodium hydroxide but **X** does not react.

Which type of oxide are each of **X**, **Y** and **Z**?

	type of oxide		
	acidic	amphoteric	basic
<b>A</b>	<b>X</b>	<b>Y</b>	<b>Z</b>
<b>B</b>	<b>Y</b>	<b>X</b>	<b>Z</b>
<b>C</b>	<b>Z</b>	<b>X</b>	<b>Y</b>
<b>D</b>	<b>Z</b>	<b>Y</b>	<b>X</b>

- 22 Which process does **not** involve the use of a transition element?
- A the manufacture of margarine from vegetable oil  
 B the manufacture of sulfuric acid in the Contact process  
 C the purification of river water to produce drinking water  
 D the removal of combustion pollutants from car exhaust gases

23 Element Q is in Period 3 of the Periodic Table. It can form ions with the formula  $Q^{3-}$ .

Which element is most likely to be Q?

- A aluminium
- B arsenic
- C phosphorus
- D sulfur

24 Which property would all the hydrogen compounds of the Group VII elements possess?

- A be covalent
- B be solids at room temperature
- C form alkaline aqueous solutions
- D conduct electricity when molten

25 A student mixed together aqueous solutions of **Y** and **Z**. A white precipitate formed.

Which could **not** be **Y** and **Z**?

	<b>Y</b>	<b>Z</b>
<b>A</b>	hydrochloric acid	silver nitrate
<b>B</b>	hydrochloric acid	sodium nitrate
<b>C</b>	sodium chloride	lead(II) nitrate
<b>D</b>	sodium chloride	silver nitrate

26 Aluminium is extracted from its molten oxide ore by electrolysis whereas zinc is extracted by reduction of its oxide when heated with coke.

Which statement explains this?

- A Aluminium is very high in the reactivity series.
- B Aluminium ores are very rare.
- C Electrolysis is a cheaper method than reduction of the oxide with coke.
- D Zinc oxide has a higher melting point than aluminium oxide.

- 27 In which solid can layers of atoms slide over each other?
- A diamond  
B graphite  
C haematite  
D silica
- 28 Which ion causes the acidity in dilute hydrochloric acid?
- A  $Cl^-$       B  $H^+$       C  $H_2^+$       D  $OH^-$
- 29 Which metal can react rapidly with steam but reacts only **very slowly** with cold water?
- A calcium  
B copper  
C iron  
D potassium
- 30 Which gas turns moist blue litmus paper red and produces a precipitate when bubbled through calcium hydroxide solution?
- A CO      B  $CO_2$       C HCl      D  $NH_3$
- 31 The diagram shows three steps in the manufacture of sulfuric acid.

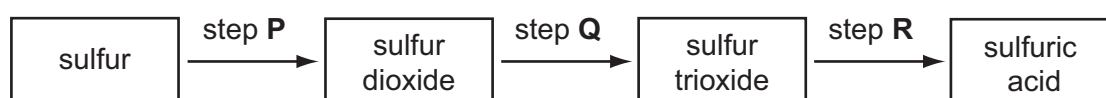

In which steps is a catalyst used?

- A step Q only  
B step R only  
C steps Q and R only  
D steps P and Q and R
- 32 Which property of compounds in a homologous series is correct?
- A They all have the same general formula.  
B They all have the same molecular formula.  
C They all have the same number of isomers.  
D They all have the same physical properties.

33 Which compound, on combustion, **never** forms carbon?

- A carbon monoxide
- B ethanol
- C ethene
- D methane

34 Which process is an example of cracking?

- A  $C_2H_4 + H_2O \rightarrow C_2H_5OH$
- B  $C_3H_6 + H_2 \rightarrow C_3H_8$
- C  $C_3H_8 + 5O_2 \rightarrow 3CO_2 + 4H_2O$
- D  $C_4H_{10} \rightarrow C_2H_4 + C_2H_6$

35 A hydride is a compound containing **only** two elements, one of which is hydrogen.

Which element can form the greatest number of different hydrides?

- A carbon
- B chlorine
- C nitrogen
- D oxygen

36 A liquid reacts with each of sodium carbonate, potassium hydroxide and ethanol.

What is the liquid?

- A aqueous ammonia
- B ethanoic acid
- C ethyl ethanoate
- D sodium hydroxide

37 Compound **X** and compound **Y** combine to form a polymer.



compound **X**



compound **Y**

Which of the statements about the polymer and its formation is **not** correct?

- A** Ammonia is formed during the production of the polymer.
- B** Hydrolysis of the polymer produces **X** and **Y**.
- C** The polymer is a polyamide.
- D** The polymer is formed by a condensation reaction.

38 The structural formulae of some organic compounds are shown below.

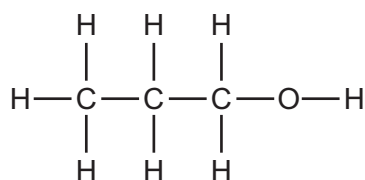

1

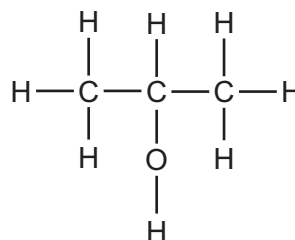

2

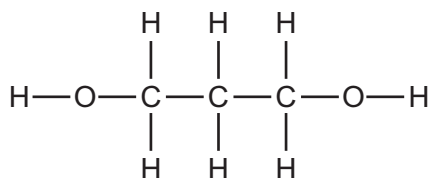

3

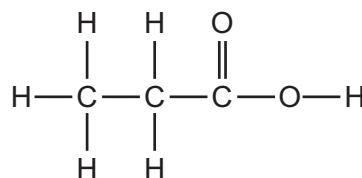

4

Which compounds are alcohols?

- A** 1 only
- B** 1 and 2 only
- C** 1, 2 and 3
- D** 4

39 What is the partial structure of the polymer formed by the polymerisation  $\text{CH}_3\text{CH}=\text{CH}_2$ ?

A

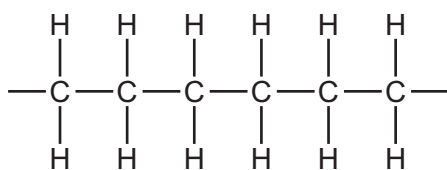

B

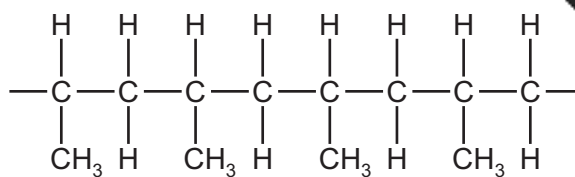

C

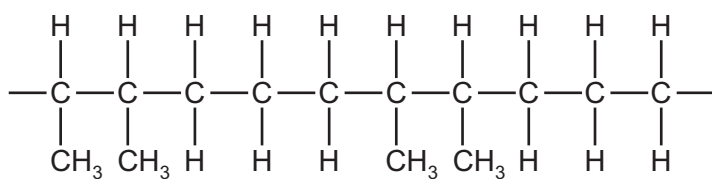

D

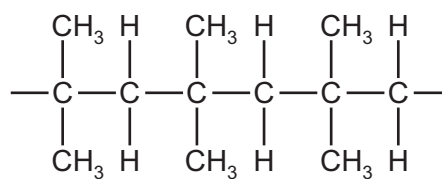

40 When a volcano erupts, which gas is produced in significant amounts?

- A carbon monoxide
- B methane
- C ozone
- D sulfur dioxide



**DATA SHEET**  
**The Periodic Table of the Elements**

		Group																			
		I	II	III	IV	V	VI	VII	VIII	IX	X										
		1 <b>H</b> Hydrogen 1																			
7	9	<b>Li</b> Lithium 3	<b>Be</b> Beryllium 4																		
23	24	<b>Na</b> Sodium 11	<b>Mg</b> Magnesium 12																		
39	40	<b>K</b> Potassium 19	<b>Ca</b> Calcium 20	45 <b>Sc</b> Scandium 21	48 <b>Ti</b> Titanium 22	51 <b>V</b> Vanadium 23	52 <b>Cr</b> Chromium 24	55 <b>Mn</b> Manganese 25	56 <b>Fe</b> Iron 26	59 <b>Co</b> Cobalt 27	59 <b>Ni</b> Nickel 28	64 <b>Cu</b> Copper 29	65 <b>Zn</b> Zinc 30	70 <b>Ga</b> Gallium 31	73 <b>Ge</b> Germanium 32	75 <b>As</b> Arsenic 33	79 <b>Se</b> Selenium 34	80 <b>Br</b> Bromine 35	84 <b>Kr</b> Krypton 36		
85	88	<b>Rb</b> Rubidium 37	<b>Sr</b> Strontium 38	89 <b>Y</b> Yttrium 39	91 <b>Zr</b> Zirconium 40	93 <b>Nb</b> Niobium 41	96 <b>Mo</b> Molybdenum 42	101 <b>Ru</b> Ruthenium 44	101 <b>Rh</b> Rhodium 45	103 <b>Rh</b> Rhodium 45	106 <b>Pd</b> Palladium 46	108 <b>Ag</b> Silver 47	112 <b>Cd</b> Cadmium 48	115 <b>In</b> Indium 49	119 <b>Sn</b> Tin 50	122 <b>Sb</b> Antimony 51	128 <b>Te</b> Tellurium 52	127 <b>I</b> Iodine 53	131 <b>Xe</b> Xenon 54		
133	137	<b>Cs</b> Caesium 55	<b>Ba</b> Barium 56	139 <b>La</b> Lanthanum 57	178 <b>Hf</b> Hafnium 72	181 <b>Ta</b> Tantalum 73	184 <b>W</b> Tungsten 74	190 <b>Os</b> Osmium 76	192 <b>Ir</b> Iridium 77	195 <b>Pt</b> Platinum 78	197 <b>Au</b> Gold 79	201 <b>Hg</b> Mercury 80	204 <b>Tl</b> Thallium 81	207 <b>Pb</b> Lead 82	209 <b>Bi</b> Bismuth 83	210 <b>Po</b> Polonium 84	210 <b>At</b> Astatine 85	210 <b>Rn</b> Radon 86			
		226 <b>Ra</b> Radium 88	227 <b>Ac</b> Actinium 89																		
												*58-71 Lanthanoid series									
												†90-103 Actinoid series									
		a		X		b		a = relative atomic mass		X = atomic symbol		b = proton (atomic) number		Key							
140	141	144	150	152	157	159	162	165	167	169	173	175	180	181	182	183	184	185	186		
<b>Ce</b> Cerium 58	<b>Pr</b> Praseodymium 59	<b>Nd</b> Neodymium 60	<b>Sm</b> Samarium 62	<b>Pm</b> Promethium 61	<b>Gd</b> Gadolinium 64	<b>Tb</b> Terbium 65	<b>Dy</b> Dysprosium 66	<b>Ho</b> Holmium 67	<b>Er</b> Erbium 68	<b>Tm</b> Thulium 69	<b>Yb</b> Ytterbium 70	<b>Lu</b> Lutetium 71	101	102	103	104	105	106	107		
232 <b>Th</b> Thorium 90	232 <b>Pa</b> Protactinium 91	238 <b>U</b> Uranium 92	238 <b>Pu</b> Plutonium 94	238 <b>Np</b> Neptunium 93	238 <b>Am</b> Americium 95	238 <b>Cm</b> Curium 96	238 <b>Bk</b> Berkelium 97	238 <b>Cf</b> Californium 98	238 <b>Es</b> Einsteinium 99	238 <b>Fm</b> Fermium 100	238 <b>Md</b> Mendelevium 101	238 <b>No</b> Nobelium 102	238 <b>Lr</b> Lawrencium 103	238	238	238	238	238	238		

The volume of one mole of any gas is 24 dm<sup>3</sup> at room temperature and pressure (r.t.p.).

Permission to reproduce items where third-party owned material protected by copyright is included has been sought and cleared where possible. Every reasonable effort has been made by the publisher (UCLES) to trace copyright holders, but if any items requiring clearance have unwittingly been included, the publisher will be pleased to make amends at the earliest possible opportunity.

Cambridge International Examinations is part of the Cambridge Assessment Group. Cambridge Assessment is the brand name of University of Cambridge Local Examinations Syndicate (UCLES), which is itself a department of the University of Cambridge.