



UNIVERSITY OF CAMBRIDGE INTERNATIONAL EXAMINATIONS
General Certificate of Education Ordinary Level

BIOLOGY

5090/11

Paper 1 Multiple Choice

October/November 2013

1 hour

Additional Materials: Multiple Choice Answer Sheet
Soft clean eraser
Soft pencil (type B or HB is recommended)



READ THESE INSTRUCTIONS FIRST

Write in soft pencil.

Do not use staples, paper clips, highlighters, glue or correction fluid.

Write your name, Centre number and candidate number on the Answer Sheet in the spaces provided unless this has been done for you.

DO NOT WRITE IN ANY BARCODES.

There are **forty** questions on this paper. Answer **all** questions. For each question there are four possible answers **A, B, C** and **D**.

Choose the **one** you consider correct and record your choice in **soft pencil** on the separate Answer Sheet.

Read the instructions on the Answer Sheet very carefully.

Each correct answer will score one mark. A mark will not be deducted for a wrong answer.

Any rough working should be done in this booklet.

Electronic calculators may be used.

This document consists of **19** printed pages and **1** blank page.



- 1 A plant is grown in bright sunlight. The diagram shows what is seen when a cell from this leaf is placed under a microscope. After a few hours, a leaf from this plant is stained with iodine solution.

What will be stained blue/black?

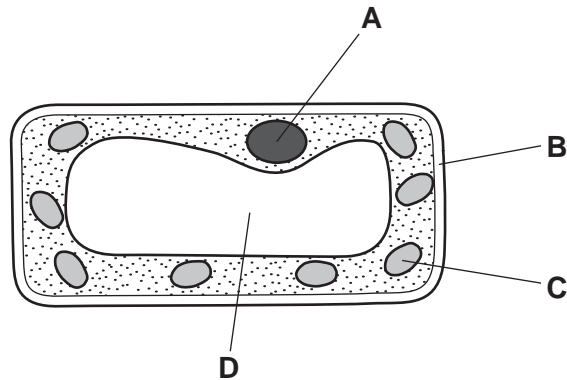

- 2 The diagram represents apparatus used to investigate osmosis.

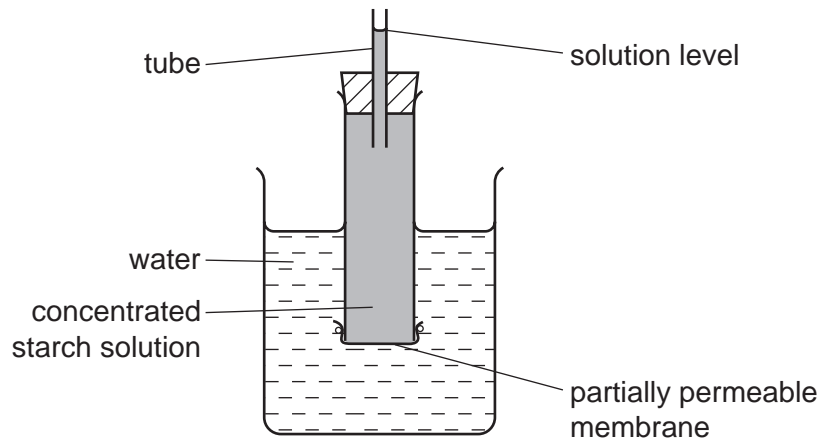

Which molecules will move across the partially permeable membrane and which change will occur in the solution level?

| | molecules | solution level |
|----------|-----------|----------------|
| A | starch | fall |
| B | starch | rise |
| C | water | fall |
| D | water | rise |

- 3 The small intestine of a person contains a lower concentration of glucose than is present in the blood.

The cells of the villi absorb glucose.

By which process is the glucose absorbed?

- A by active transport against the concentration gradient
- B by active transport with the concentration gradient
- C by diffusion against the concentration gradient
- D by diffusion with the concentration gradient

- 4 Which statements are correct for all enzymes?

- 1 They are proteins.
- 2 They are secreted into the alimentary canal.
- 3 They speed up biochemical reactions.
- 4 None of them work at low pH.

- A 1 and 3 B 1 and 4 C 2 and 3 D 2 and 4

- 5 Which signs show that a plant has been grown in soil deficient in magnesium ions?

- A no flowers and poor root growth
- B small leaves and more roots
- C white upper leaves and no flowers
- D yellow stem and yellow leaves

- 6 What is a function of each of these types of plant cell?

| | phloem cells | root hair cells |
|---|-----------------|-----------------|
| A | sugar transport | ion uptake |
| B | sugar transport | transpiration |
| C | photosynthesis | ion uptake |
| D | photosynthesis | transpiration |

7 The diagram represents a cross section of part of a leaf.

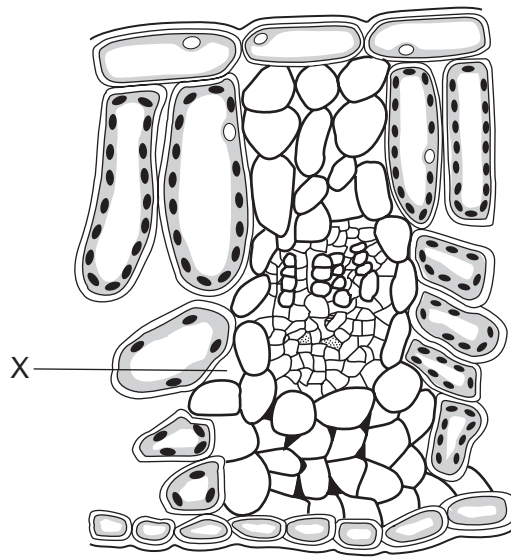

How does the oxygen content of the air at X compare to normal atmospheric air, when the leaf is in the light and when it is in the dark?

| | in the light | in the dark |
|----------|--------------|-------------|
| A | lower | the same |
| B | lower | higher |
| C | higher | the same |
| D | higher | lower |

- 8 An investigation is carried out on digestion and absorption in the alimentary canal. The diagram shows the apparatus used. The visking tubing is permeable to small molecules such as glucose but not to large molecules such as starch.

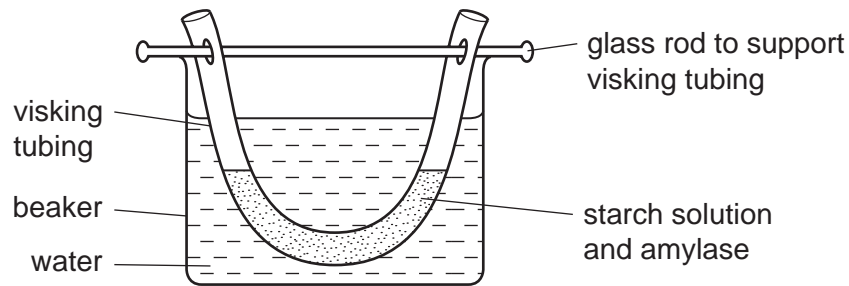

After one hour, samples of water in **the beaker** are tested with Benedict's solution and with iodine solution.

Which colours are obtained?

| | colour obtained after heating with Benedict's solution | colour obtained after adding iodine solution |
|----------|--|--|
| A | blue | blue-black |
| B | blue | yellow-brown |
| C | red | blue-black |
| D | red | yellow-brown |

- 9 What are the substrate and end-products of digestion by the enzyme lipase?

| | substrate | end-product |
|----------|--------------|--------------------------|
| A | carbohydrate | glucose |
| B | fat | amino acids |
| C | fat | fatty acids and glycerol |
| D | protein | fatty acids and glycerol |

10 Food tests were carried out on four different substances.

Which substance contained both protein and reducing sugar?

| substance | Benedict's test | biuret test | emulsion test | iodine test |
|-----------|-----------------|-------------|---------------|-------------|
| A | ✓ | ✓ | ✗ | ✗ |
| B | ✓ | ✗ | ✓ | ✓ |
| C | ✗ | ✓ | ✓ | ✗ |
| D | ✗ | ✗ | ✗ | ✓ |

key

✓ = positive

✗ = negative

11 In which direction do water molecules move in the phloem and in the xylem of a plant stem?

| | phloem | xylem |
|----------|------------------|------------------|
| A | down only | up only |
| B | up only | down only |
| C | up only | both up and down |
| D | both up and down | up only |

12 Four similar leafy shoots are exposed to different conditions. The rates of water uptake and the rates of water loss are measured.

The results are shown in the table.

Which shoot is most likely to wilt?

| | water uptake /mm ³ per min | water loss /mm ³ per min |
|----------|--|--|
| A | 14 | 13 |
| B | 10 | 12 |
| C | 5 | 5 |
| D | 4 | 2 |

13 What is the correct route for blood flow in a human?

- A** left atrium → left ventricle → lungs → right ventricle → right atrium
- B** left atrium → left ventricle → right ventricle → right atrium → lungs
- C** right atrium → right ventricle → left ventricle → left atrium → lungs
- D** right atrium → right ventricle → lungs → left atrium → left ventricle

14 The table refers to blood vessels in the human body.

| vessel | blood carried | | oxygenated / deoxygenated |
|---------------------|------------------|----------------------------|------------------------------|
| | from | to | |
| aorta | P | all organs except lungs | oxygenated |
| pulmonary vein | lungs | heart | Q |
| hepatic artery | aorta | R | oxygenated |
| hepatic portal vein | alimentary canal | liver | S |

What are **P**, **Q**, **R** and **S**?

| | P | Q | R | S |
|----------|-----------------|--------------|----------|--------------|
| A | left ventricle | deoxygenated | kidney | deoxygenated |
| B | left ventricle | oxygenated | liver | deoxygenated |
| C | right ventricle | deoxygenated | kidney | oxygenated |
| D | right ventricle | oxygenated | liver | oxygenated |

15 The diagram shows an investigation of blood flow in the veins of the lower arm.

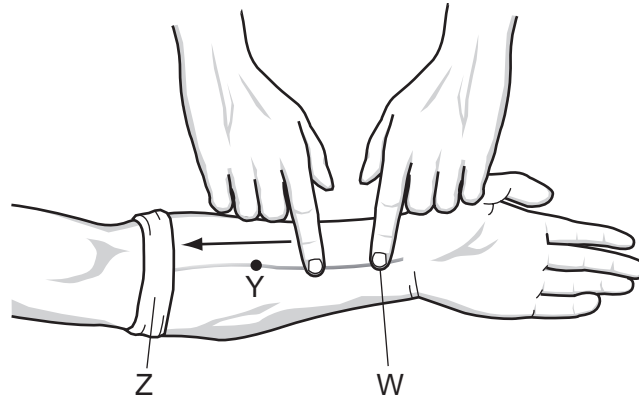

A cloth is tightly wrapped round the arm at point Z and the veins stand out clearly. One finger presses firmly on the vein at W.

When another finger strokes the vein, as shown in the diagram, the vein lies flat between points W and Y.

Four reasons are given to explain why the vein lies flat.

- 1 The bandage at Z prevents backflow of blood.
- 2 The finger pressed at W prevents more blood entering the vein.
- 3 A valve at Y prevents backflow of blood.
- 4 A valve at Z prevents more blood from entering the vein.

Which are correct?

- A** 1 and 2 **B** 1 and 4 **C** 2 and 3 **D** 2 and 4

- 16 Seals are marine mammals. When they dive under water, they are capable of respiring anaerobically for long periods. During this time, blood flow to the muscles is greatly reduced but the muscles are able to tolerate high concentrations of lactic acid.

The graph shows the concentrations of lactic acid and oxygen in the blood of a seal before, during and after a dive.

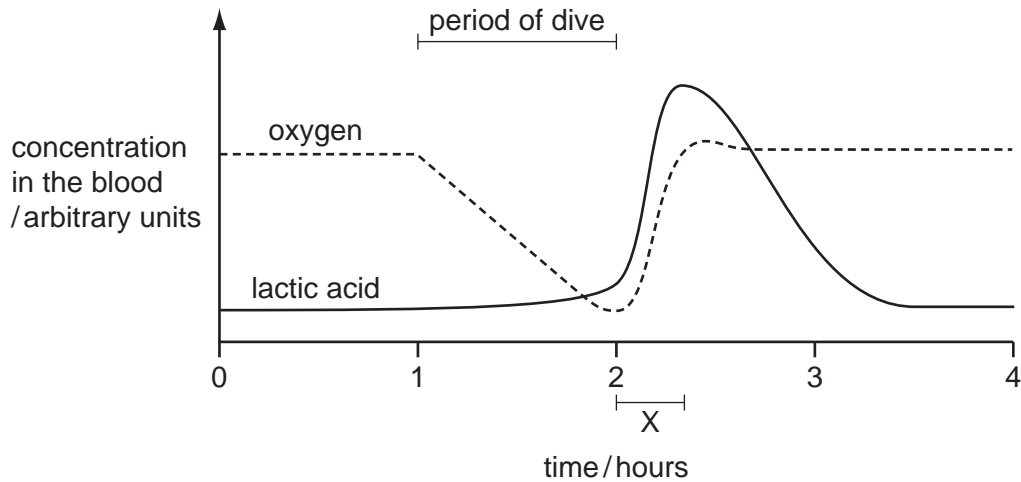

What explains the change in lactic acid concentration during time X?

- A increased lactic acid production
 - B increased blood flow to the muscles
 - C increased rate of aerobic respiration
 - D reduced rate of anaerobic respiration
- 17 Which process does **not** result in an overall loss of energy from the organism?
- A a boy running a hundred metres
 - B photosynthesis in a green plant
 - C respiration in an animal
 - D the germination of a seed of a flowering plant

18 A person begins to smoke a cigarette at time X. The graph shows how their heart rate changes.

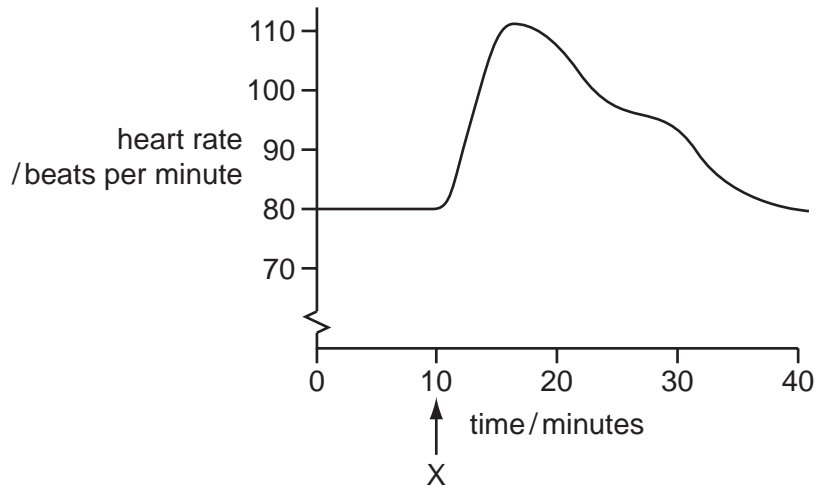

Which substance in cigarette smoke is the main cause of the change in heart rate between 10 and 18 minutes?

- A carbon monoxide
- B nicotine
- C smoke particles
- D tar

19 In a kidney dialysis machine, which substance **cannot** diffuse through the dialysis membrane?

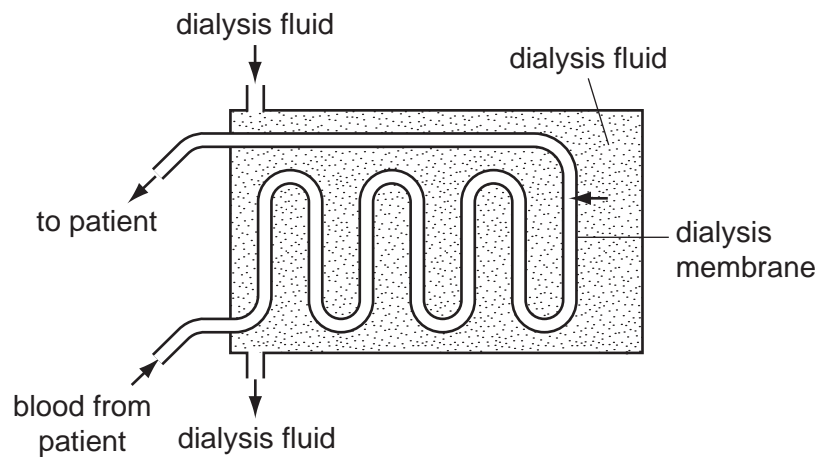

- A glucose
- B insulin
- C sodium
- D urea

20 The diagram shows some of the structures seen in a section through human skin.

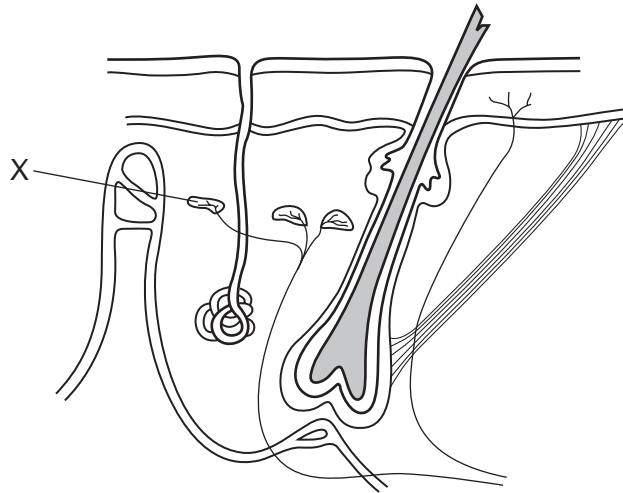

What is the function of structure X?

- A** to cause capillaries to constrict
- B** to detect changes in temperature
- C** to receive impulses from the central nervous system
- D** to stimulate sweat glands to release sweat

21 Which row describes the shoulder joint of an arm?

| | shoulder joint | | |
|----------|--------------------|--------------------|---------------------------|
| | bones | joint type | action |
| A | radius ulna | ball and socket | flexion and extension |
| B | scapula humerus | ball and socket | rotation |
| C | radius ulna | hinge | rotation and extension |
| D | scapula humerus | hinge | flexion and extension |

22 The diagram shows a section through the eye.

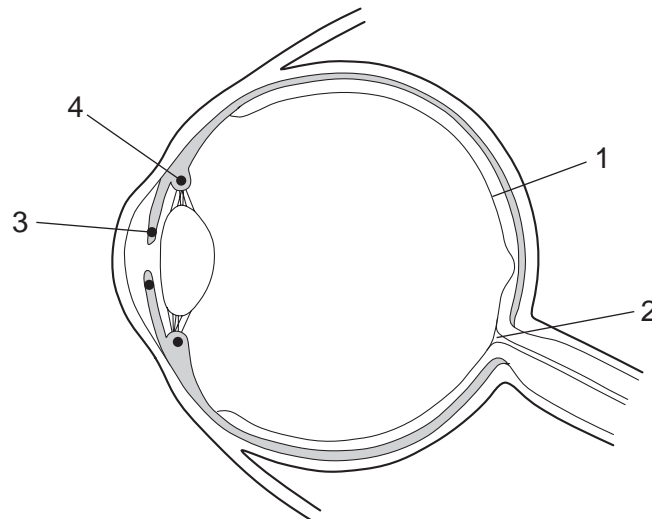

In the pupil reflex, which row gives the sites of the effectors and receptors involved?

| | effectors | receptors |
|----------|-----------|-----------|
| A | 3 | 1 |
| B | 3 | 2 |
| C | 4 | 1 |
| D | 4 | 2 |

23 In a person suffering from diabetes mellitus, how do the concentrations of glucose in the blood and in the urine differ from those of a healthy person?

| | concentration of glucose in blood | concentration of glucose in urine |
|----------|-----------------------------------|-----------------------------------|
| A | higher | higher |
| B | higher | same |
| C | same | lower |
| D | lower | lower |

- 24 A local anaesthetic is a drug used to block nerve impulses. The diagram represents part of the nervous system. X, Y, and Z show sites where the anaesthetic can be injected.

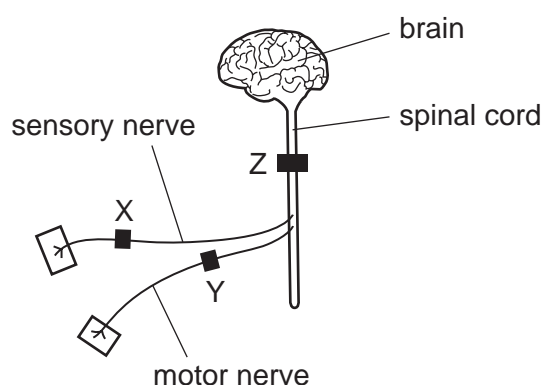

In an experiment, one person can feel a pin prick their leg but cannot move their leg.

Where was the anaesthetic injected in this person?

- A** at X
B at Y
C at Z
D at X and at Y
- 25 Chemicals in tobacco smoke lead to the breakdown of the elastic tissue in the walls of the alveoli.
- What is the name of this condition?
- A** bronchitis
B emphysema
C lung cancer
D pneumonia
- 26 The table shows the characteristics of four microorganisms.

Which one could be a virus?

| | contains DNA | contains one or more cells | contains one or more cell nuclei | produces spores |
|----------|--------------|----------------------------|----------------------------------|-----------------|
| A | x | x | x | x |
| B | ✓ | ✓ | x | x |
| C | ✓ | ✓ | ✓ | x |
| D | ✓ | ✓ | ✓ | ✓ |

key

✓ = true

x = false

27 When bacteria act on milk, which row describes the formation of yoghurt?

| | substrate | product | pH |
|----------|-------------|-------------|--------|
| A | glucose | starch | lower |
| B | lactic acid | lactose | higher |
| C | lactose | lactic acid | lower |
| D | starch | glucose | higher |

28 Which processes increase and decrease the amount of carbon dioxide in the air?

| | process causing increase in carbon dioxide | process causing decrease in carbon dioxide |
|----------|--|--|
| A | burning of fossil fuels | respiration of plants |
| B | photosynthesis in plants | respiration of bacteria |
| C | respiration of animals | photosynthesis in plants |
| D | respiration of bacteria | burning of fossil fuels |

29 The flow chart shows part of a food web in a field.

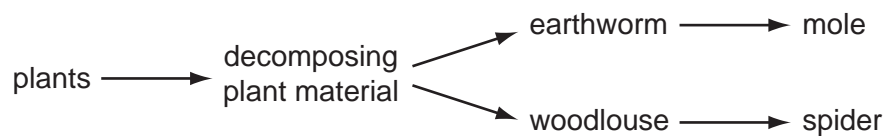

What describes **both** the earthworm and the woodlouse?

- A** carnivore and consumer
- B** consumer and herbivore
- C** decomposer and herbivore
- D** producer and carnivore

30 The diagram shows parts of the nitrogen cycle.

Which arrow represents the action of the root nodule bacteria of leguminous plants?

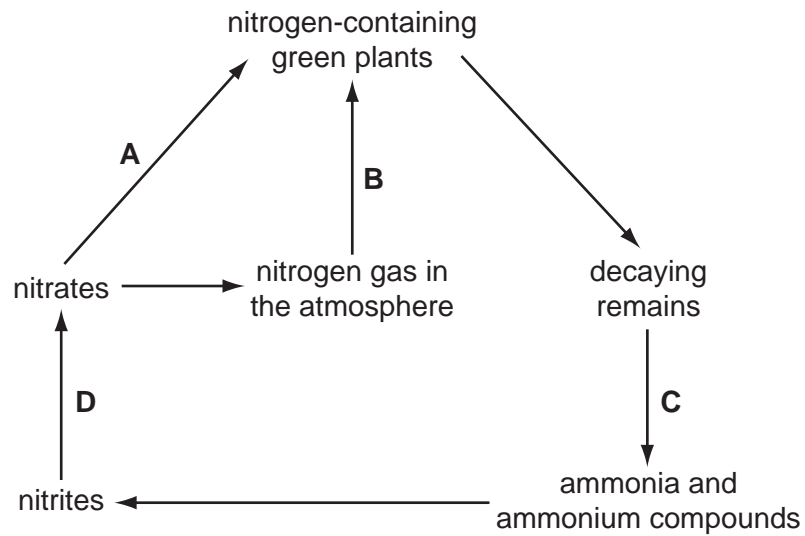

31 One method of preventing malaria is to reduce the number of vectors.

Which control method will achieve this?

- A** Cover areas of standing water to prevent mosquitoes from laying eggs.
- B** Use an anti-malarial drug that kills the malarial pathogen in the human body.
- C** Use an anti-malarial drug that inhibits the reproduction of the malarial pathogen.
- D** Use mosquito nets that prevent mosquitoes from sucking blood.

32 The graph shows how the pH of a lake has changed in the period 1500 AD to 2000 AD.

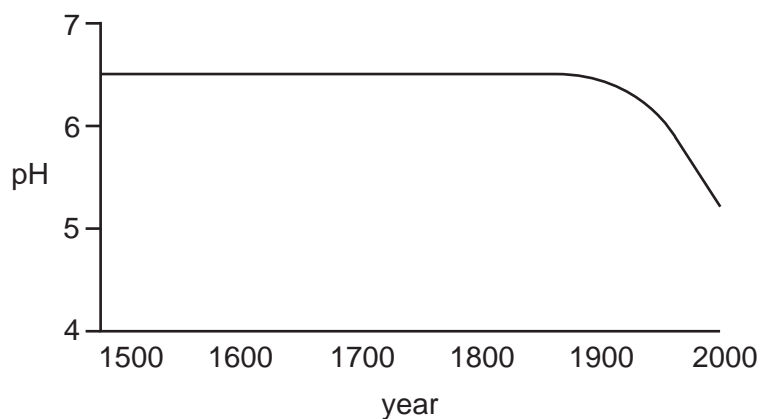

What could have caused the change in the pH over the last 100 years?

- A burning of fossil fuels in factories
- B conversion of nearby woodlands to agricultural land
- C increased growth of plants in the lake
- D use of insecticides on nearby fields

33 The diagram shows an experiment to find out if seeds need oxygen to germinate.

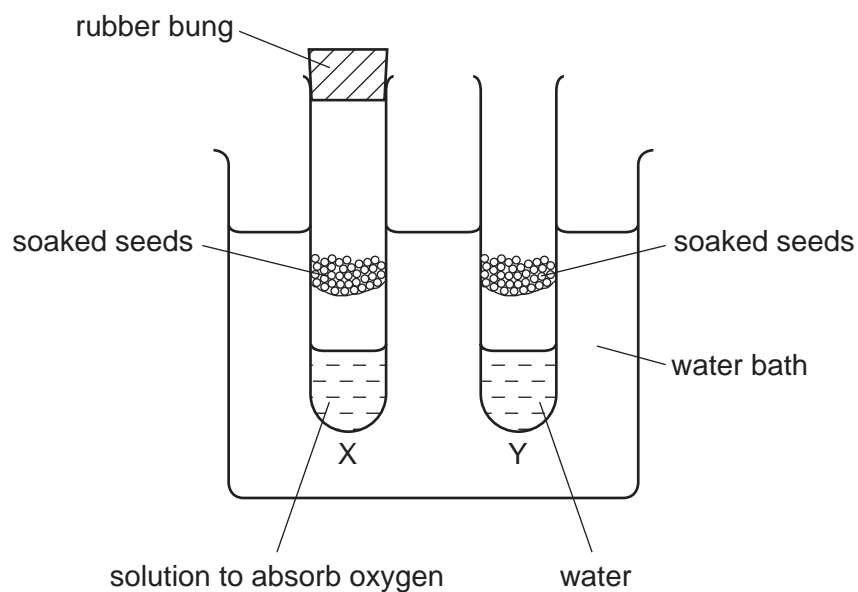

Which change would make tube Y an effective control?

- A Add soda lime (absorbs carbon dioxide) at the bottom of tube Y.
- B Close tube Y with a rubber bung.
- C Do not soak the seeds in tube Y.
- D Replace the soaked seeds in tube Y with seeds that have been boiled.

34 The diagram shows part of a flower after it has been pollinated.

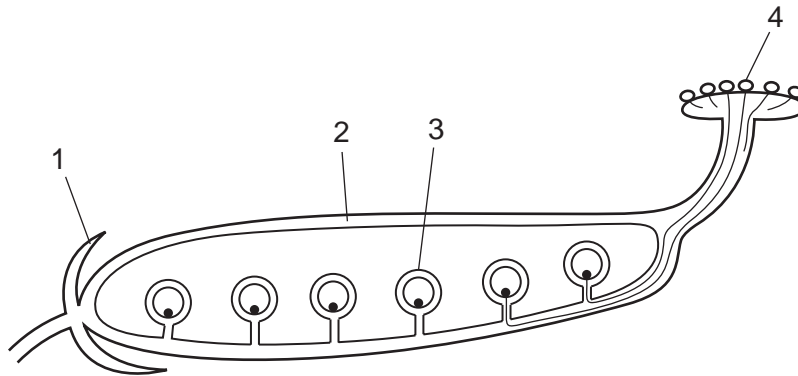

Which row correctly identifies one of the labelled structures?

| | labelled structure | flower part |
|----------|--------------------|-------------|
| A | 1 | petal |
| B | 2 | seed |
| C | 3 | ovule |
| D | 4 | stigma |

35 What is the result of cutting both the sperm ducts in a man?

- A** He is unable to develop sperms.
- B** He is unable to pass urine.
- C** Male sex hormones no longer circulate in his blood.
- D** Sperm are not emitted from the urethra.

36 The diagram shows a section through the female reproductive system.

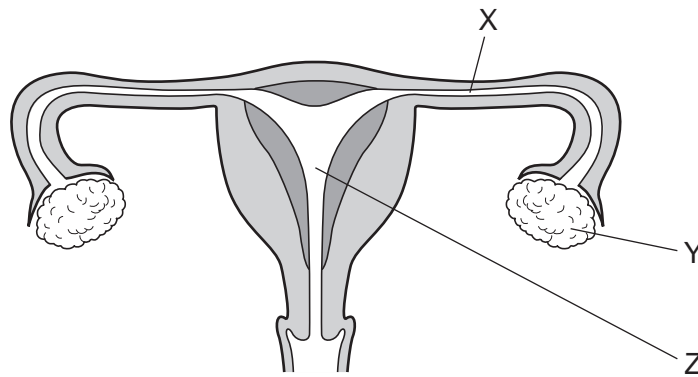

During pregnancy, where does mitosis occur in the cells of the embryo?

| | X | Y | Z |
|----------|---|---|---|
| A | ✓ | ✓ | ✓ |
| B | ✓ | ✓ | x |
| C | ✓ | x | ✓ |
| D | x | x | ✓ |

key

✓ = takes place

x = does not take place

37 Some genotypes that occur in blood groups are given.

Which genotype results in a phenotype that shows co-dominance?

A $I^A I^A$

B $I^A I^B$

C $I^B I^O$

D $I^O I^O$

38 A human cell contains all of the following.

Which is the smallest in size?

A gene

B nucleus

C X-chromosome

D Y-chromosome

39 The allele for white flowers is recessive to the allele for red flowers.

Which statement is **not** correct?

- A An allele for red in the genotype will always be seen in the phenotype.
- B Crossing two heterozygotes will produce an approximate 3 : 1 ratio.
- C Red flowers are always heterozygous.
- D White flowers are always homozygous.

40 What is a result of natural selection?

- A dogs that are friendly to humans
- B grapes that contain no seeds
- C mosquitoes that are resistant to insecticides
- D onion crops that have a pleasant taste

BLANK PAGE

Permission to reproduce items where third-party owned material protected by copyright is included has been sought and cleared where possible. Every reasonable effort has been made by the publisher (UCLES) to trace copyright holders, but if any items requiring clearance have unwittingly been included, the publisher will be pleased to make amends at the earliest possible opportunity.

Cambridge International Examinations is part of the Cambridge Assessment Group. Cambridge Assessment is the brand name of University of Cambridge Local Examinations Syndicate (UCLES), which is itself a department of the University of Cambridge.