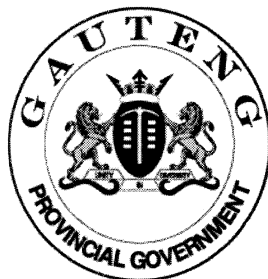


CANDIDATE'S NUMBER / KANDIDAAT SE NOMMER

--	--	--	--	--	--	--	--	--	--

**SENIOR CERTIFICATE EXAMINATION**  
**SENIORSERTIFIKAAT-EKSAMEN**



**OCTOBER / NOVEMBER**  
**OKTOBER / NOVEMBER**

**2004**

**GEOGRAPHY**

**AARDRYKSKUNDE**

**(First Paper)**  
**(Eerste Vraestel)**

**DIAGRAM BOOK**  
**DIAGRAMBOEK**



**502-1/X**

**8 pages**  
**8 bladsye**

**COPYRIGHT RESERVED / KOPIEREG VOORBEHOU**  
**APPROVED BY UMALUSI / GOEDGEKEUR DEUR UMALUSI**





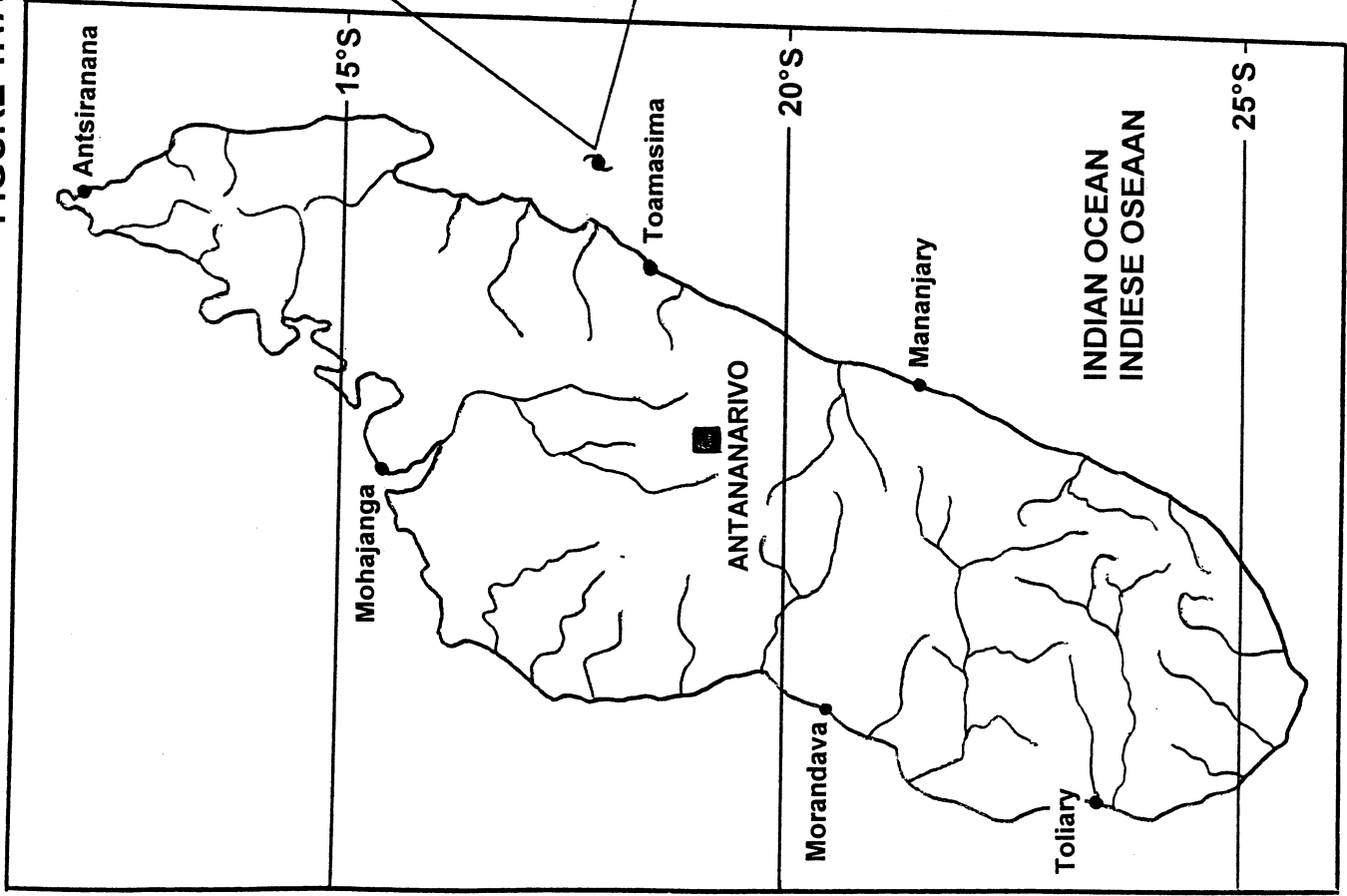
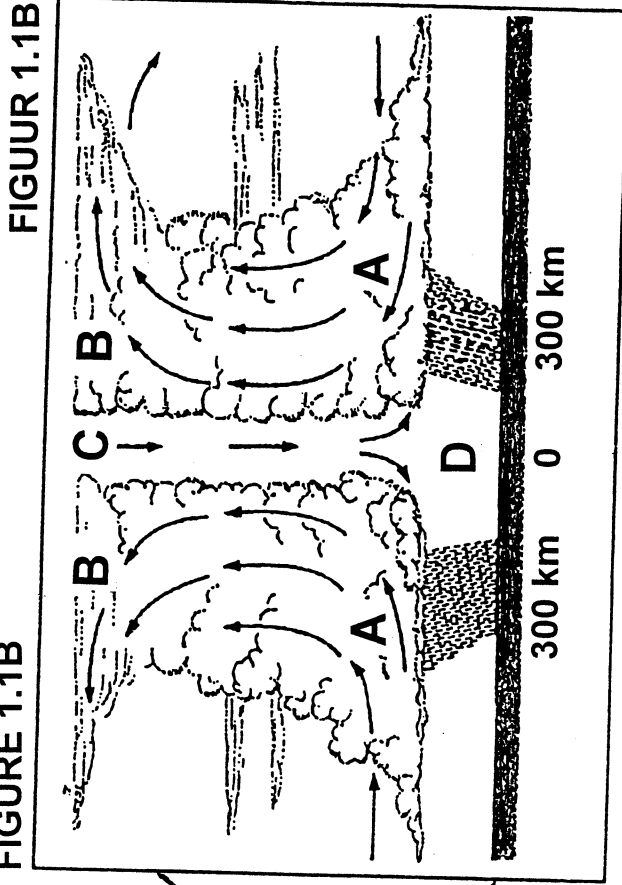
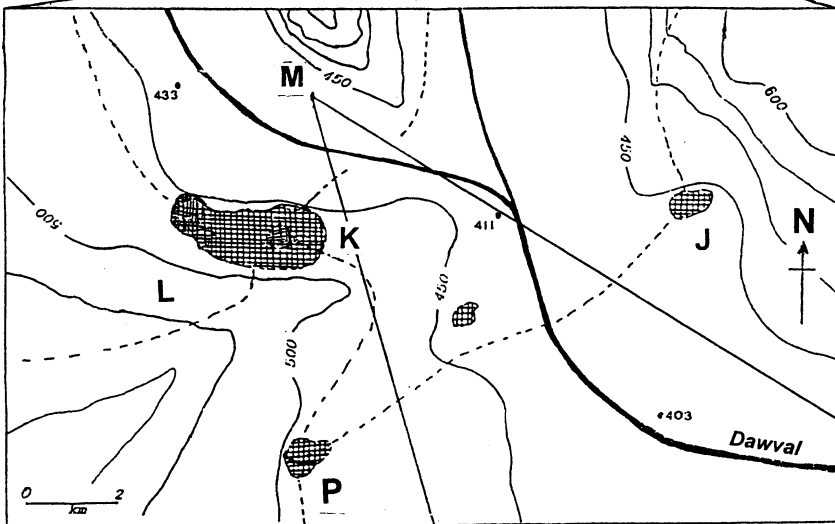
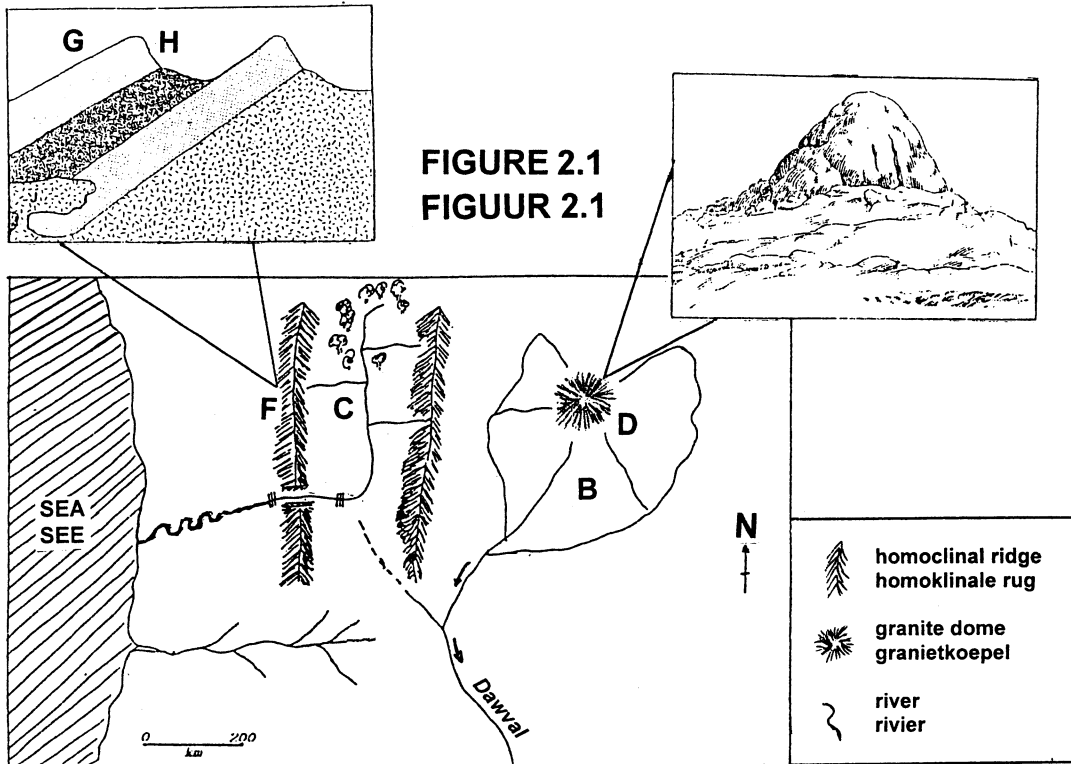


FIGURE 1.1B

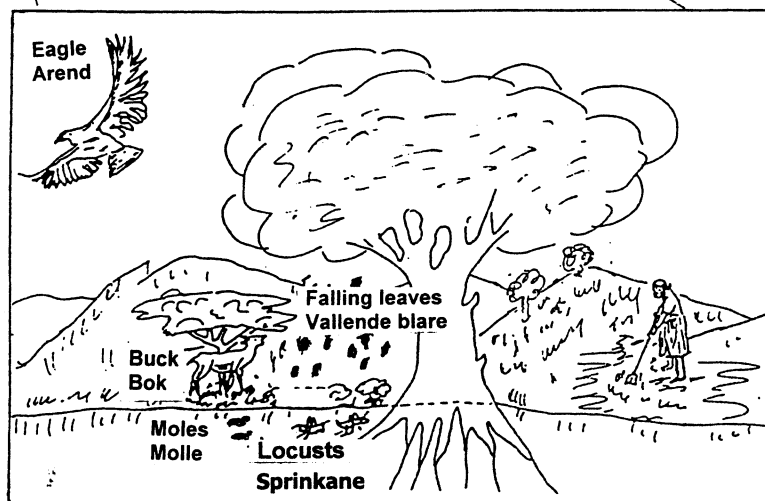


FIGUUR 1.1B

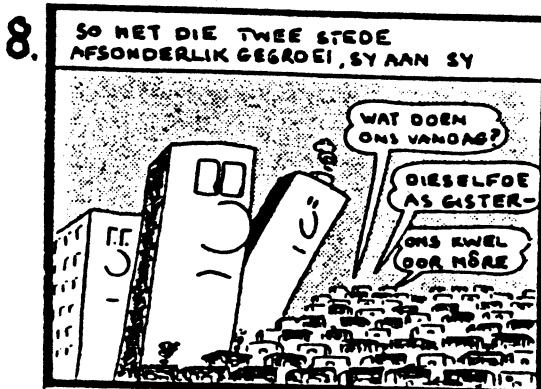
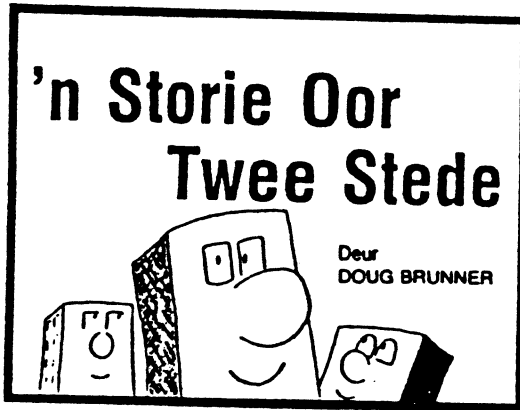




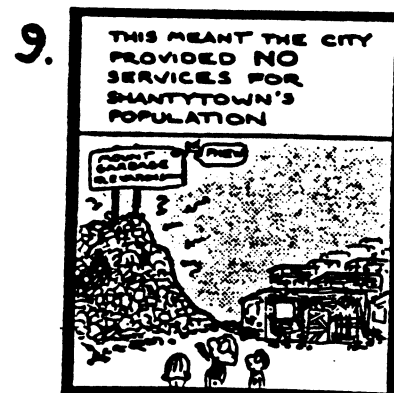
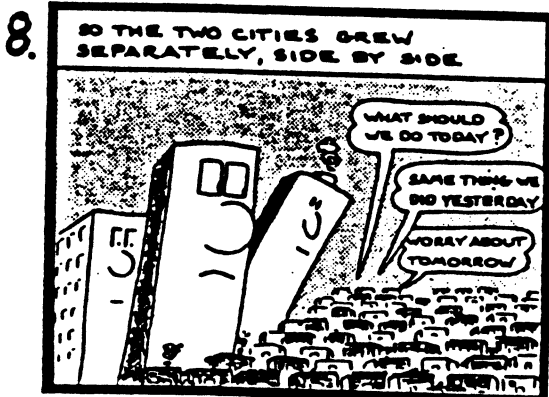
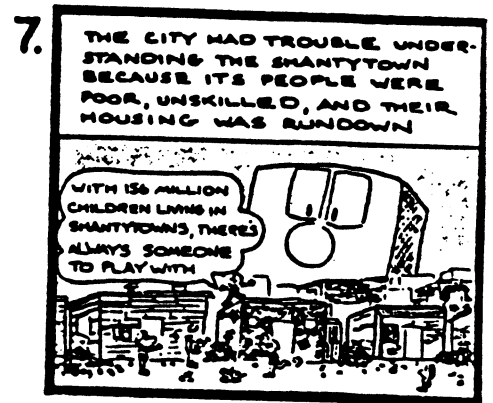
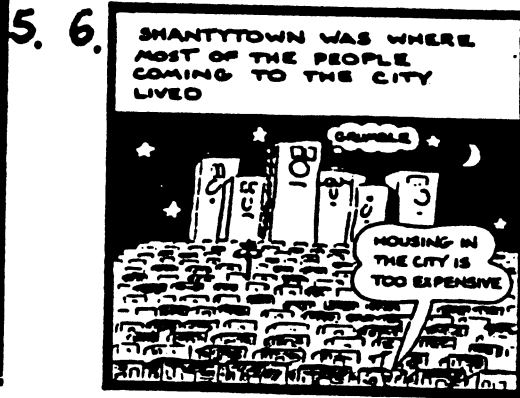
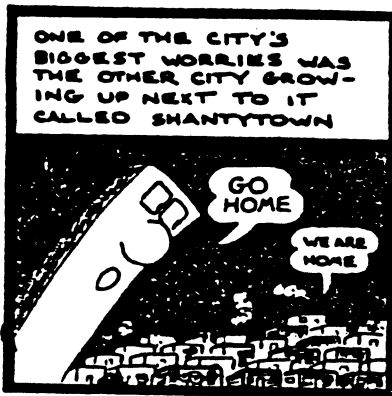
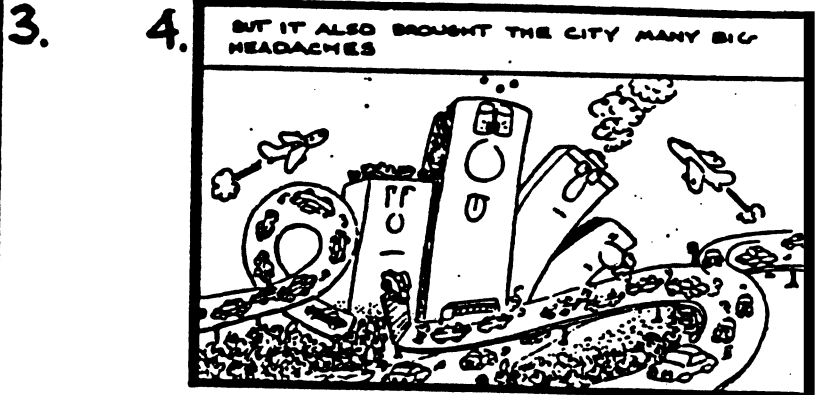
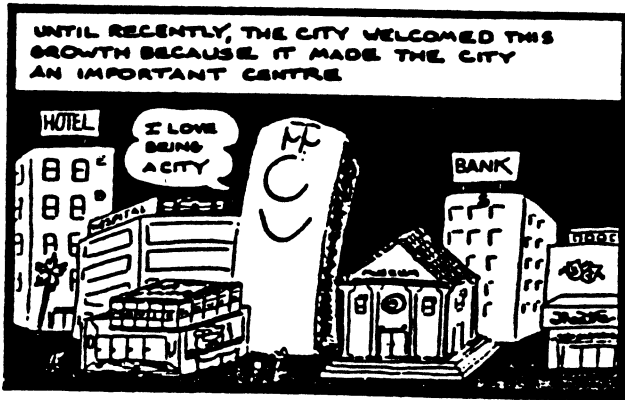
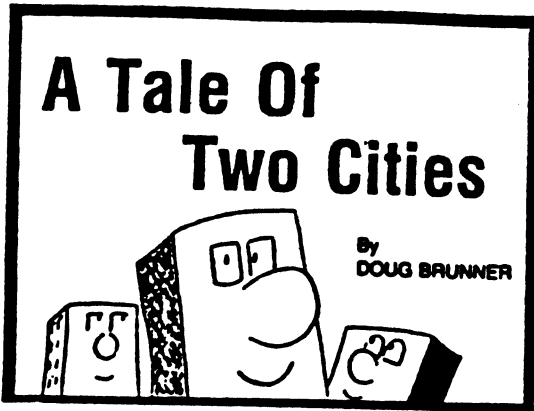
**FIGURE 2.3**  
**FIGUUR 2.3**



# FIGUUR 3



# FIGURE 3



10.



11.



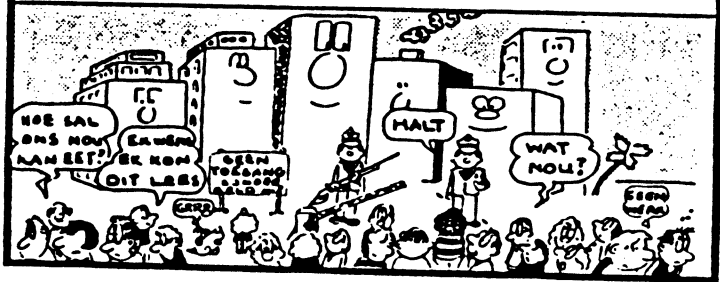
NAMATE DIE BUURSTAD GROTER GEWORD HET, HET DIE STAD BANG GEWOKO DAT DIT GROTER AS HY SOU WORD

12.

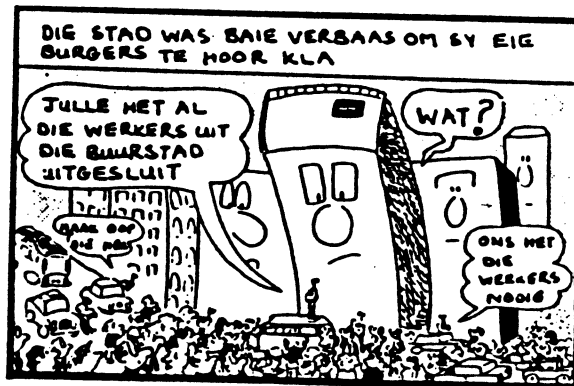


TOTDAT DIE STAD EENDAG GESE HET "GENOEG" EN BESLUIT HET OM NIEMAND UIT DIE BUURSTAD TOE TE LAAT OM DIE STAD BINNE TE KOM NIE

13.



14.



15.

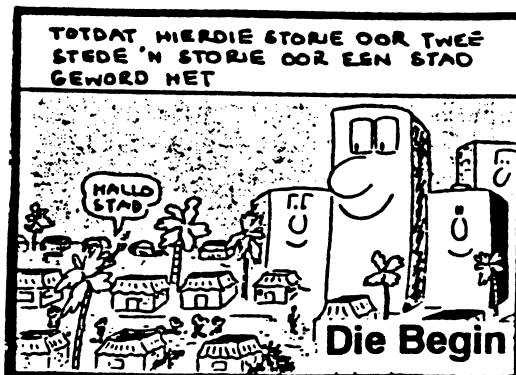
16.



17.



18.



19.



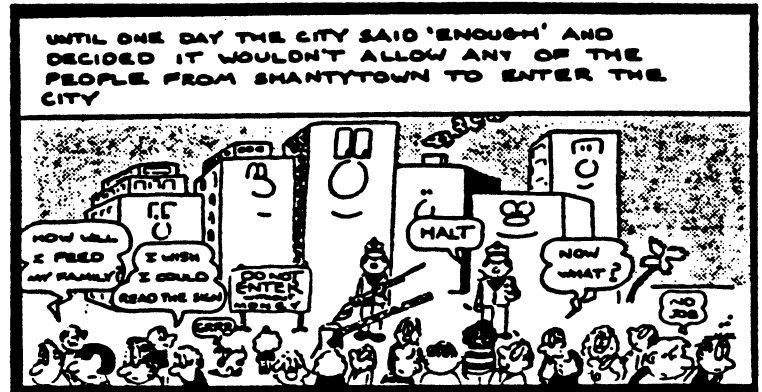
10.



11.

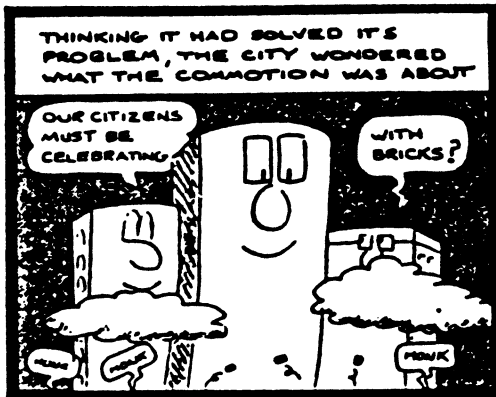


12.



13.

14.



15.



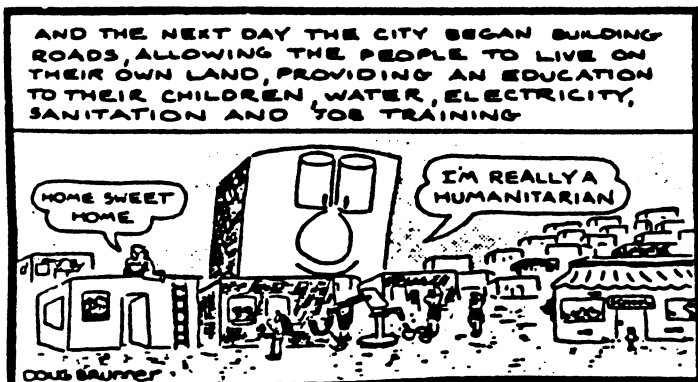
16.



17.



19.



18.

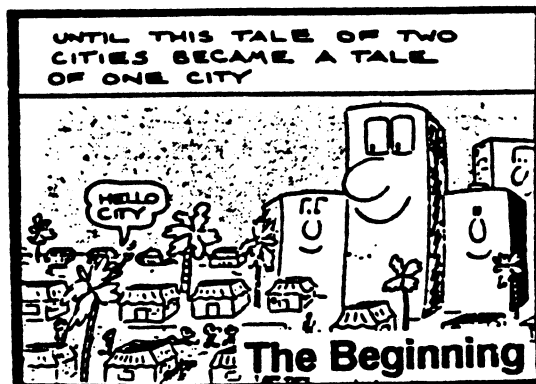




FIGURE 4A

FIGUUR 4A

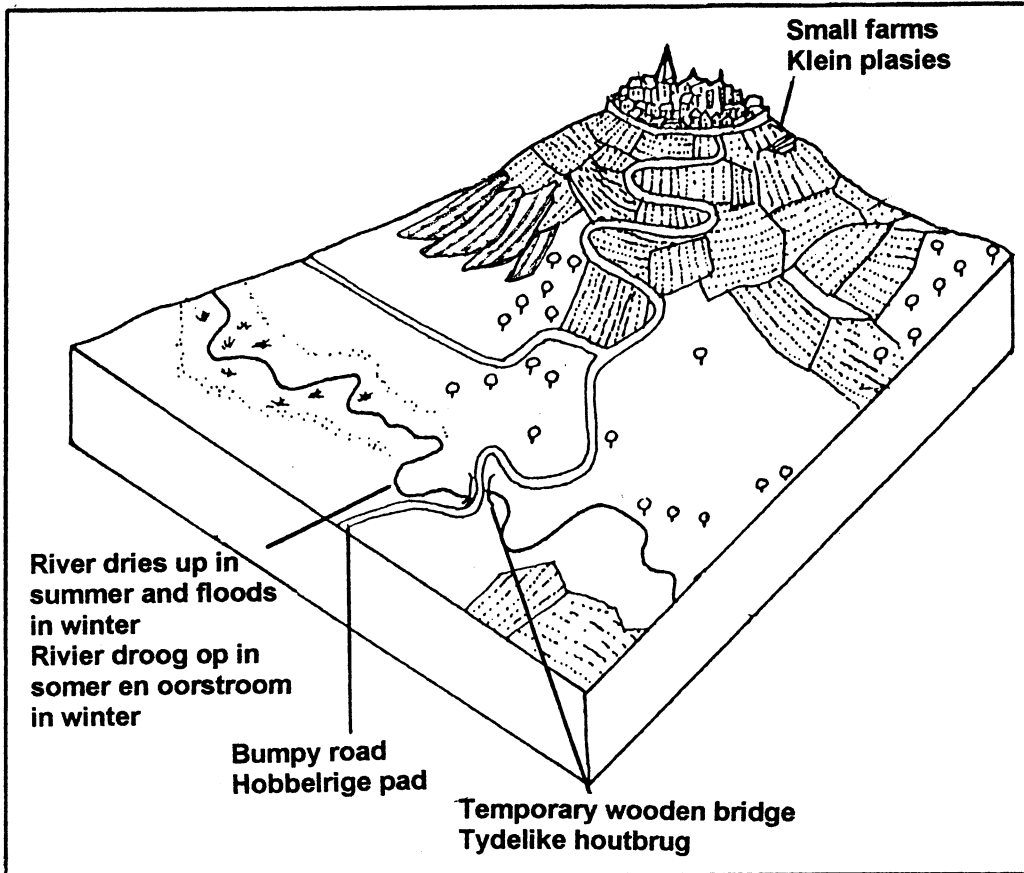


FIGURE 4B

FIGUUR 4B

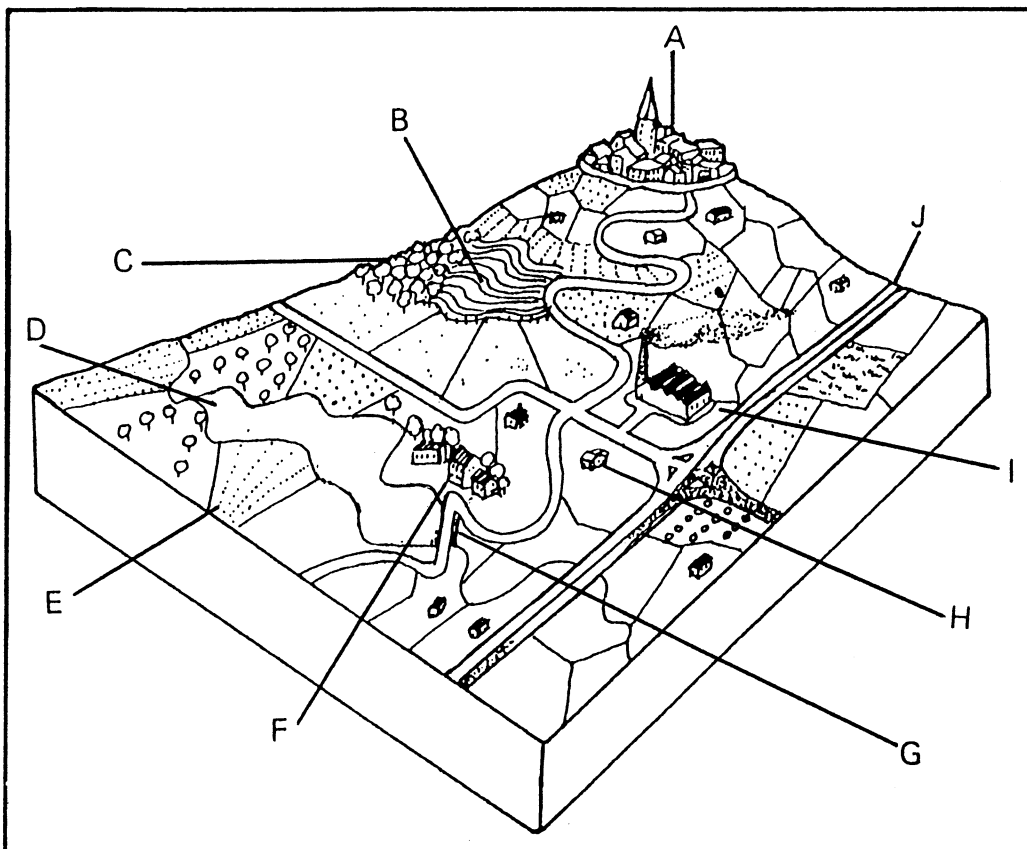
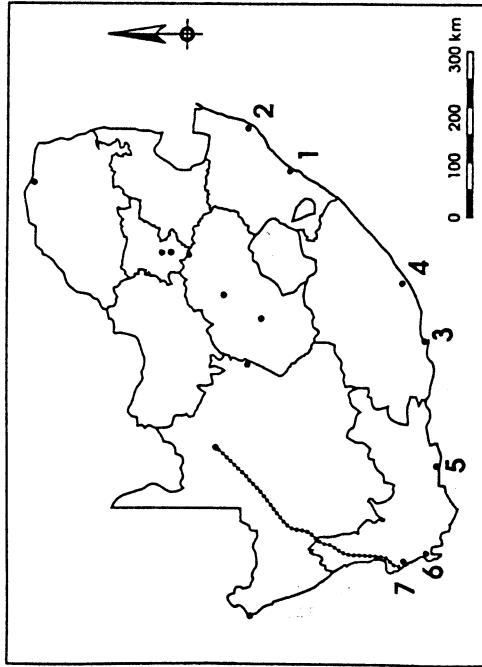




FIGURE 5.1A



- 1 Durban
- 2 Richards Bay
- 3 Richardsbaai
- 4 Port Elizabeth
- 5 East London
- 6 Oos-Londen
- 7 Mossel Bay
- 8 Mosselbaai
- 9 Cape Town
- 10 Kaapstad
- 11 Saldanha Bay
- 12 Saldanhabaai

FIGUUR 5.1A

FIGURE 5.1B

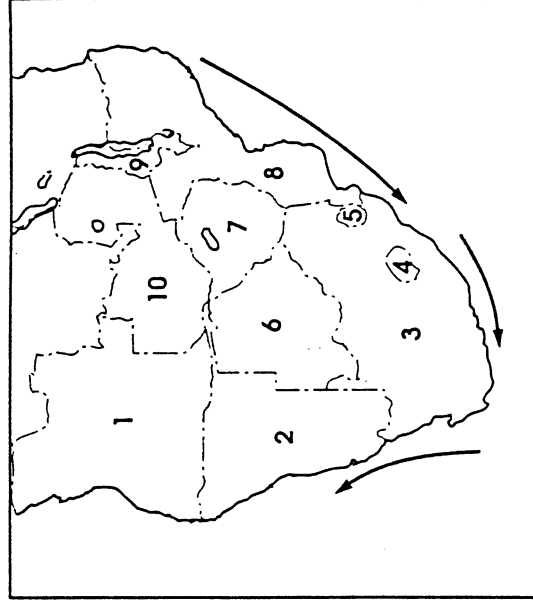


TABLE 5.2 GROSS DOMESTIC PRODUCT PER PROVINCE (R milliard)  
 TABEL 5.2 BRUTO BINNELANDSE PRODUK PER PROVINSE (R miljard)

Province Provinse	Agriculture Landbou	Mining Mynbou	Industry Nywerheid	Electricity generation Elektrisiteits- opwekking	Construction Konstruksie	Trade Handel	Transport Vervoer	Finance Finansies	Community service Gemeenskaps- diens	Total Totaal
Eastern Cape	3,1	0,3	11,6	0,7	1,5	7,7	4,6	7,1	20,2	56,9
Oos-Kaap	3,1	4,8	7,3	1,9	0,9	4,3	3,4	4,7	11,5	41,8
Free State	1,4	8,1	51,7	6,4	8,9	40,7	35,4	80,5	55,6	288,8
Vrystaat	2,9	0,7	27,9	2,6	3,0	2,0	11,6	15,3	24,2	100,1
KwaZulu/Natal	3,5	12,1	15,4	7,2	1,2	4,9	2,8	3,1	9,8	59,5
Mpumalanga	2,4	18,1	4,0	0,5	0,9	5,1	2,7	3,4	11,4	48,5
North-West	1,7	1,8	0,8	0,4	0,3	2,1	1,8	1,5	3,8	14,1
Noordwes	1,7	5,1	2,0	1,4	1,1	4,5	2,0	2,7	12,2	32,8
Northern Cape Noord-Kaap	5,6	0,7	28,3	1,8	4,3	22,5	15,7	42,7	29,5	151,0
Limpopo	25,4	51,6	148,9	23,0	22,2	103,9	80,1	161,0	178,1	794,0
Western Cape Wes-Kaap										
South Africa Suid-Afrika										



FIGURE 6.1

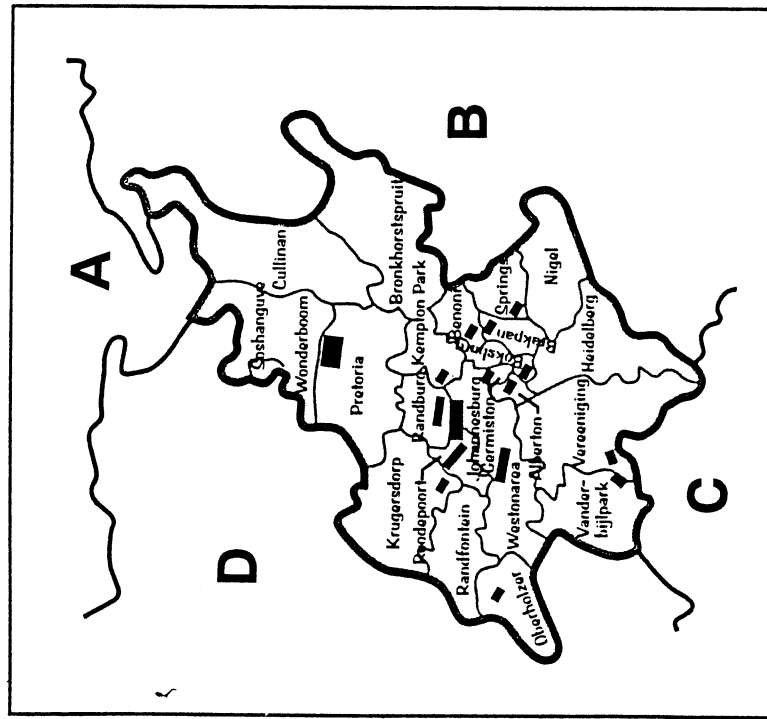
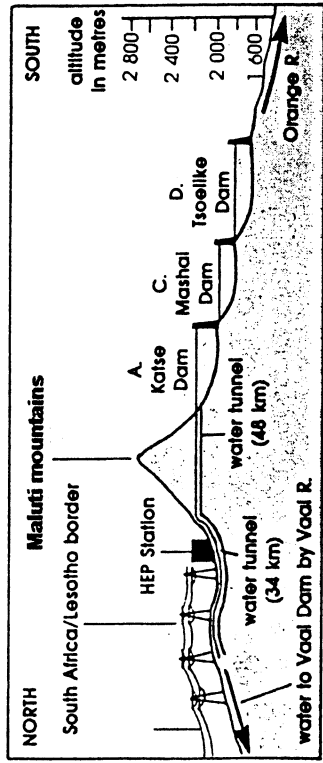


FIGURE 6.3



FIGUUR 6.3

