



## Coimisiún na Scrúduithe Stáit

## SCRÚDÚ AN TEASTAIS SHÓISEARAIGH, 2010

ÁBHAIR AGUS TEICNEOLAÍOCHT  
MIOTALÓIREACHT

GNÁTHLEIBHÉAL - 100 Marc

Dé Máirt 22 Meitheamh, Tráthnóna 2:00 go dtí 3:30

Uimhir an  
Ionaid

Scrúduimhir



## TREORACHA

1. Freagair **Ceist 1, Roinn A agus Roinn B** agus **trí** cheist **ar bith** eile.
2. Freagair na ceisteanna sna  spásanna atá ann dóibh nó cuir tic sa bhosca cúí.
3. Tabhair an páipéar seo ar ais ag deireadh an scrúdaithe.

Don Scrúdaitheoir	
Móriomlán na Marcanna	<input type="text"/>
Ceist	Marc
1A	
1B	
2	
3	
4	
5	
6	
<b>Iomlán</b>	
<b>Grád</b>	



1. Iomlán na n-iomlán bunleathanaigh	
2. Iomlán na marcanna ar cheisteanna dícheadaithe	
3. Móriomlán na marcanna a bronnadh (1 lúide 2)	
4. Bónas i gcomhair freagairt trí Ghaeilge. (más cúí)	
5. Iomlán na marcanna a bronnadh má tá Bónas Gaeilge i gceist (3 + 4)	
<b>Nóta:</b> ní mór don mharc i sraith 3 ( nó i sraith 5 má bhronntar an Bónas Gaeilge) a bheith mar an gcéanna leis an marc sa bhosca <u>Móriomlán na Marcanna</u> ar an scrípt.	

**NÁ DÉAN DEARMAD DO SCRÚDUIMHIR A CHUR SA BHOSCA ATÁ ANN  
DI AR AN LEATHANACH SEO**

**Ceist 1.**

**ROINN A - 20 MARC**  
**FREAGAIR DEICH gCEIST AR BITH AS AN ROINN SEO**

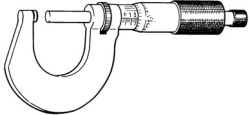
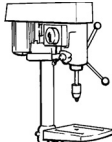
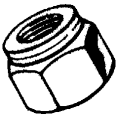
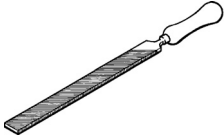
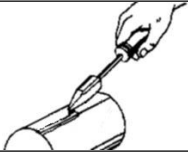
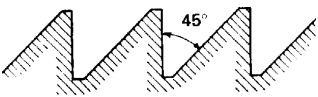
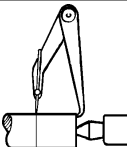
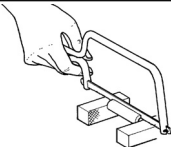
**40 Marc**

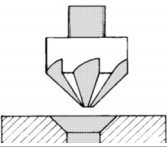
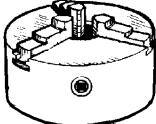
<p>(a)</p> 	<p>Úsáidtear eochracha Allen chun go gcasfaí:</p>	<table border="1"> <tr><td>Scríúna Cinn Soicéid</td><td></td></tr> <tr><td>Scríúna Ceannchruinne</td><td></td></tr> <tr><td>Scríúna Cinn Mulcháin</td><td></td></tr> <tr><td>Scríúna Ceannardaithe</td><td></td></tr> </table>	Scríúna Cinn Soicéid		Scríúna Ceannchruinne		Scríúna Cinn Mulcháin		Scríúna Ceannardaithe	
Scríúna Cinn Soicéid										
Scríúna Ceannchruinne										
Scríúna Cinn Mulcháin										
Scríúna Ceannardaithe										
<p>(b)</p> 	<p>Is é atá san uirlis seo ná:</p>	<table border="1"> <tr><td>Bacart Láir</td><td></td></tr> <tr><td>Micriméadar</td><td></td></tr> <tr><td>Cailipéar Vernier</td><td></td></tr> <tr><td>Beibheal</td><td></td></tr> </table>	Bacart Láir		Micriméadar		Cailipéar Vernier		Beibheal	
Bacart Láir										
Micriméadar										
Cailipéar Vernier										
Beibheal										
<p>(c)</p> 	<p>Is é atá sa mheaisín seo ná:</p>	<table border="1"> <tr><td>Meaisín Druileála Piléir</td><td></td></tr> <tr><td>Druilire Láimhe Leictreach</td><td></td></tr> <tr><td>Uchtdruilire</td><td></td></tr> <tr><td>Druilire Láimhe</td><td></td></tr> </table>	Meaisín Druileála Piléir		Druilire Láimhe Leictreach		Uchtdruilire		Druilire Láimhe	
Meaisín Druileála Piléir										
Druilire Láimhe Leictreach										
Uchtdruilire										
Druilire Láimhe										
<p>(d)</p> 	<p>Is é atá sa cheanglóir seo ná:</p>	<table border="1"> <tr><td>Cnó Eiteach</td><td></td></tr> <tr><td>Bolta</td><td></td></tr> <tr><td>Pionna Scoilte</td><td></td></tr> <tr><td>Glaschnó</td><td></td></tr> </table>	Cnó Eiteach		Bolta		Pionna Scoilte		Glaschnó	
Cnó Eiteach										
Bolta										
Pionna Scoilte										
Glaschnó										
<p>(e)</p> 	<p>Déantar líomháin as:</p>	<table border="1"> <tr><td>Cruach Bhog</td><td></td></tr> <tr><td>Cruach Dhosmálta</td><td></td></tr> <tr><td>Cruach Ardcharbóin</td><td></td></tr> <tr><td>Cruach Airgid</td><td></td></tr> </table>	Cruach Bhog		Cruach Dhosmálta		Cruach Ardcharbóin		Cruach Airgid	
Cruach Bhog										
Cruach Dhosmálta										
Cruach Ardcharbóin										
Cruach Airgid										
<p>(f)</p> 	<p>Is é atá san uirlis ghearrtha seo ná:</p>	<table border="1"> <tr><td>Gréisc</td><td></td></tr> <tr><td>Ola</td><td></td></tr> <tr><td>Spealtar</td><td></td></tr> <tr><td>Flosc</td><td></td></tr> </table>	Gréisc		Ola		Spealtar		Flosc	
Gréisc										
Ola										
Spealtar										
Flosc										
<p>(g)</p> 	<p>Is é atá sa snáithchruth seo ná:</p>	<table border="1"> <tr><td>Snáithe Cearnógach</td><td></td></tr> <tr><td>Snáithe Taca</td><td></td></tr> <tr><td>Snáithe Aicmé</td><td></td></tr> <tr><td>Snáithe Méadrach ISO</td><td></td></tr> </table>	Snáithe Cearnógach		Snáithe Taca		Snáithe Aicmé		Snáithe Méadrach ISO	
Snáithe Cearnógach										
Snáithe Taca										
Snáithe Aicmé										
Snáithe Méadrach ISO										
<p>(h)</p> 	<p>Is é atá san uirlis seo ná:</p>	<table border="1"> <tr><td>Cailipéar Seachtrach</td><td></td></tr> <tr><td>Cailipéar Inmheánach</td><td></td></tr> <tr><td>Cailipéar Corrchosach</td><td></td></tr> <tr><td>Rannadóir Sprionga</td><td></td></tr> </table>	Cailipéar Seachtrach		Cailipéar Inmheánach		Cailipéar Corrchosach		Rannadóir Sprionga	
Cailipéar Seachtrach										
Cailipéar Inmheánach										
Cailipéar Corrchosach										
Rannadóir Sprionga										
<p>(i)</p> 	<p>Is é atá san uirlis ghearrtha seo ná:</p>	<table border="1"> <tr><td>Mionchróshábh</td><td></td></tr> <tr><td>Mionsábh Miotail</td><td></td></tr> <tr><td>Líomhán Teannais</td><td></td></tr> <tr><td>Crios-Sábh</td><td></td></tr> </table>	Mionchróshábh		Mionsábh Miotail		Líomhán Teannais		Crios-Sábh	
Mionchróshábh										
Mionsábh Miotail										
Líomhán Teannais										
Crios-Sábh										
<p>(j)</p> 	<p>Is é atá sa ghléas coinneála seo ná:</p>	<table border="1"> <tr><td>Bís Choise</td><td></td></tr> <tr><td>Bís Bhinse</td><td></td></tr> <tr><td>Bís Láimhe</td><td></td></tr> <tr><td>Bís Mheaisín</td><td></td></tr> </table>	Bís Choise		Bís Bhinse		Bís Láimhe		Bís Mheaisín	
Bís Choise										
Bís Bhinse										
Bís Láimhe										
Bís Mheaisín										
<p>(k)</p> 	<p>Taispeánann an líníocht seo:</p>	<table border="1"> <tr><td>Poll Fritollta</td><td></td></tr> <tr><td>Poll Leacaithe</td><td></td></tr> <tr><td>Treoirpholl</td><td></td></tr> <tr><td>Poll Caoch</td><td></td></tr> </table>	Poll Fritollta		Poll Leacaithe		Treoirpholl		Poll Caoch	
Poll Fritollta										
Poll Leacaithe										
Treoirpholl										
Poll Caoch										
<p>(l)</p> 	<p>Is é atá sa pháirt deile seo ná:</p>	<table border="1"> <tr><td>Post Uirlise</td><td></td></tr> <tr><td>Crágán</td><td></td></tr> <tr><td>Cúlstoc</td><td></td></tr> <tr><td>Ríscríú</td><td></td></tr> </table>	Post Uirlise		Crágán		Cúlstoc		Ríscríú	
Post Uirlise										
Crágán										
Cúlstoc										
Ríscríú										

**ROINN B - 20 MARC**  
**FREAGAIR GACH CEIST AS AN ROINN SEO**

(m)

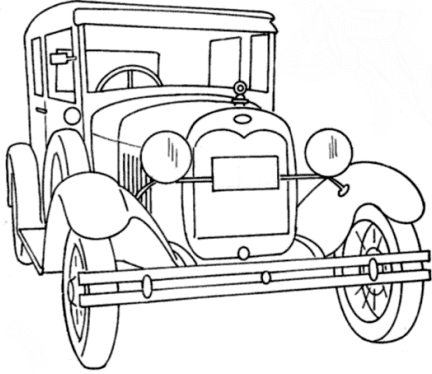

Liostaigh **ceithre** fheabhsúchán teicneolaíochta a bhfuil fáil orthu i gcarranna nua-aimseartha.

1.	
2.	
3.	
4.	

(n)

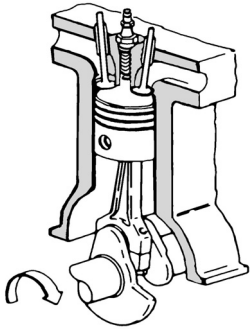

(i) Cén fáth a n-úsáidtear ola in inneall cairr?

(ii) Ainmnigh **dhá** pháirt ar bith d'inneall cairr.

1.	2.
----	----

(o) (i) Soláthraíonn ceallra cairr:

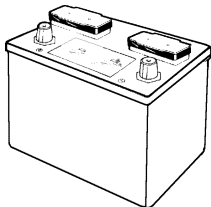

12v DC	
100v DC	
200v AC	
150v AC	

(ii) Ainmnigh an miotal a úsáidtear i gceallraí carr.

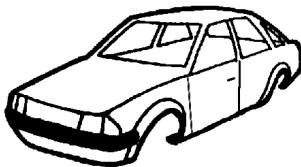

(p) (i) Déantar cabhlacha carr as:



Cruach	
Iarann Galbhánaithe	
Alúmanam	
Tungsten	

(ii) Ainmnigh modh amháin a úsáidtear chun creimeadh ar chabhail cairr a chosc.

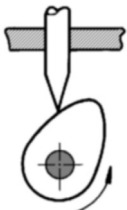
(q) (i) Is é atá sa mheicníocht seo ná:



Giar	
Ceam	
Crág	
Coscán	

(ii) Liostaigh úsáid leis an meicníocht seo.

**(a)**

- |   |                    |  |                       |  |                  |  |   |                         |  |                           |  |                              |  |
|---|--------------------|--|-----------------------|--|------------------|--|---|-------------------------|--|---------------------------|--|------------------------------|--|
| <p>(i) Is cóimhiotal é cruach de:</p> <table border="1" style="width: 100%; border-collapse: collapse;"> <tr><td>Iarann agus carbón</td><td></td></tr> <tr><td>Iarann agus stán</td><td></td></tr> <tr><td>Iarann agus sinc</td><td></td></tr> </table>     | Iarann agus carbón |  | Iarann agus stán      |  | Iarann agus sinc |  | <p>(v) Deirtear go bhfuil ábhar sobhrسته nuair is furasta é:</p> <table border="1" style="width: 100%; border-collapse: collapse;"> <tr><td>a Shíneadh</td><td></td></tr> <tr><td>a Leá</td><td></td></tr> <tr><td>a Bhriseadh</td><td></td></tr> </table>  | a Shíneadh              |  | a Leá                     |  | a Bhriseadh                  |  |
| Iarann agus carbón  |                    |  |                       |  |                  |  |   |                         |  |                           |  |                              |  |
| Iarann agus stán  |                    |  |                       |  |                  |  |   |                         |  |                           |  |                              |  |
| Iarann agus sinc  |                    |  |                       |  |                  |  |   |                         |  |                           |  |                              |  |
| a Shíneadh  |                    |  |                       |  |                  |  |   |                         |  |                           |  |                              |  |
| a Leá   |                    |  |                       |  |                  |  |   |                         |  |                           |  |                              |  |
| a Bhriseadh   |                    |  |                       |  |                  |  |   |                         |  |                           |  |                              |  |
| <p>(ii) Is cóimhiotal é cré-umha de:</p> <table border="1" style="width: 100%; border-collapse: collapse;"> <tr><td>Copar &amp; Sinc</td><td></td></tr> <tr><td>Copar &amp; Luaidhe</td><td></td></tr> <tr><td>Copar &amp; Stán</td><td></td></tr> </table> | Copar & Sinc       |  | Copar & Luaidhe       |  | Copar & Stán     |  | <p>(vi) Táirgtear iarann teilgthe as:</p> <table border="1" style="width: 100%; border-collapse: collapse;"> <tr><td>Amhiarann</td><td></td></tr> <tr><td>Muciarann</td><td></td></tr> <tr><td>Slaig</td><td></td></tr> </table>  | Amhiarann               |  | Muciarann                 |  | Slaig                        |  |
| Copar & Sinc  |                    |  |                       |  |                  |  |   |                         |  |                           |  |                              |  |
| Copar & Luaidhe   |                    |  |                       |  |                  |  |   |                         |  |                           |  |                              |  |
| Copar & Stán  |                    |  |                       |  |                  |  |   |                         |  |                           |  |                              |  |
| Amhiarann   |                    |  |                       |  |                  |  |   |                         |  |                           |  |                              |  |
| Muciarann   |                    |  |                       |  |                  |  |   |                         |  |                           |  |                              |  |
| Slaig   |                    |  |                       |  |                  |  |   |                         |  |                           |  |                              |  |
| <p>(iii) Is é is alúmanam ann ná:</p> <table border="1" style="width: 100%; border-collapse: collapse;"> <tr><td>Miotal Feiriúil</td><td></td></tr> <tr><td>Miotal Neamhfheiriúil</td><td></td></tr> <tr><td>Cóimhiotal</td><td></td></tr> </table>         | Miotal Feiriúil    |  | Miotal Neamhfheiriúil |  | Cóimhiotal       |  | <p>(vii) Is é a thugtar ar chruach bhog a bhíonn cumhdaithe le sinc ná:</p> <table border="1" style="width: 100%; border-collapse: collapse;"> <tr><td>Stánphláta</td><td></td></tr> <tr><td>Iarann Galbhánaithe</td><td></td></tr> <tr><td>Cruach Chóimhiotal</td><td></td></tr> </table>                    | Stánphláta              |  | Iarann Galbhánaithe       |  | Cruach Chóimhiotal           |  |
| Miotal Feiriúil   |                    |  |                       |  |                  |  |   |                         |  |                           |  |                              |  |
| Miotal Neamhfheiriúil   |                    |  |                       |  |                  |  |   |                         |  |                           |  |                              |  |
| Cóimhiotal  |                    |  |                       |  |                  |  |   |                         |  |                           |  |                              |  |
| Stánphláta  |                    |  |                       |  |                  |  |   |                         |  |                           |  |                              |  |
| Iarann Galbhánaithe   |                    |  |                       |  |                  |  |   |                         |  |                           |  |                              |  |
| Cruach Chóimhiotal  |                    |  |                       |  |                  |  |   |                         |  |                           |  |                              |  |
| <p>(iv) Chun cruach ardluais a dhéanamh úsáidtear:</p> <table border="1" style="width: 100%; border-collapse: collapse;"> <tr><td>Uirlisí Gearrtha</td><td></td></tr> <tr><td>Geataí</td><td></td></tr> <tr><td>Boinn Airgid</td><td></td></tr> </table>    | Uirlisí Gearrtha   |  | Geataí                |  | Boinn Airgid     |  | <p>(viii) Deirtear go bhfuil ábhar crua nuair is féidir leis:</p> <table border="1" style="width: 100%; border-collapse: collapse;"> <tr><td>Leictreachas a Sheoladh</td><td></td></tr> <tr><td>Seasamh in aghaidh Ídithe</td><td></td></tr> <tr><td>Seasamh in aghaidh Meirgíthe</td><td></td></tr> </table> | Leictreachas a Sheoladh |  | Seasamh in aghaidh Ídithe |  | Seasamh in aghaidh Meirgíthe |  |
| Uirlisí Gearrtha  |                    |  |                       |  |                  |  |   |                         |  |                           |  |                              |  |
| Geataí  |                    |  |                       |  |                  |  |   |                         |  |                           |  |                              |  |
| Boinn Airgid  |                    |  |                       |  |                  |  |   |                         |  |                           |  |                              |  |
| Leictreachas a Sheoladh   |                    |  |                       |  |                  |  |   |                         |  |                           |  |                              |  |
| Seasamh in aghaidh Ídithe   |                    |  |                       |  |                  |  |   |                         |  |                           |  |                              |  |
| Seasamh in aghaidh Meirgíthe  |                    |  |                       |  |                  |  |   |                         |  |                           |  |                              |  |

**(b)**

- (i) Cén meascán a chuirtear isteach san Fhoirnéis Soinneáin?
- |  |
|--|
|  |
|  |
|  |
- (ii) Cad é aidhm an 'Tuyere'?
- |  |
|--|
|  |
|  |
|  |
- (iii) Cad a tharlaíonn don iarann leáite?
- |  |
|--|
|  |
|  |
|  |

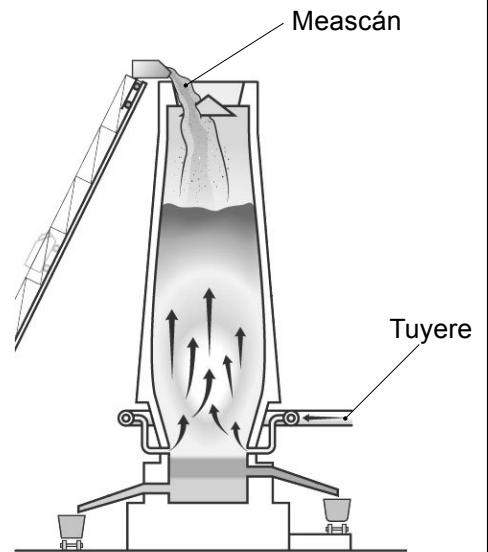

**(c)**

- |  |             |  |                     |  |                 |  |  |                |  |                   |  |              |  |
|--|-------------|--|---------------------|--|-----------------|--|--|----------------|--|-------------------|--|--------------|--|
| <p>(i) Is é a thugtar freisin ar bhileog aicrileach ná:</p> <table border="1" style="width: 100%; border-collapse: collapse;"> <tr><td>Poileistear</td><td></td></tr> <tr><td>Bácaillt</td><td></td></tr> <tr><td>Peirspéacs</td><td></td></tr> </table>                 | Poileistear |  | Bácaillt            |  | Peirspéacs      |  | <p>(iv) Cé acu ceann díobh seo ar Teirmeaplaisteach é?</p> <table border="1" style="width: 100%; border-collapse: collapse;"> <tr><td>Poileistear</td><td></td></tr> <tr><td>PVC</td><td></td></tr> <tr><td>Bácaillt</td><td></td></tr> </table>                 | Poileistear    |  | PVC               |  | Bácaillt     |  |
| Poileistear  |             |  |                     |  |                 |  |  |                |  |                   |  |              |  |
| Bácaillt   |             |  |                     |  |                 |  |  |                |  |                   |  |              |  |
| Peirspéacs   |             |  |                     |  |                 |  |  |                |  |                   |  |              |  |
| Poileistear  |             |  |                     |  |                 |  |  |                |  |                   |  |              |  |
| PVC  |             |  |                     |  |                 |  |  |                |  |                   |  |              |  |
| Bácaillt   |             |  |                     |  |                 |  |  |                |  |                   |  |              |  |
| <p>(ii) Is féidir giaranna a dhéanamh as:</p> <table border="1" style="width: 100%; border-collapse: collapse;"> <tr><td>Níolón</td><td></td></tr> <tr><td>Poileitiléin</td><td></td></tr> <tr><td>PVC</td><td></td></tr> </table>                                       | Níolón      |  | Poileitiléin        |  | PVC             |  | <p>(v) Cé acu ceann díobh seo ar Plaisteach Teirmithéachtach é?</p> <table border="1" style="width: 100%; border-collapse: collapse;"> <tr><td>Bácaillt</td><td></td></tr> <tr><td>Níolón</td><td></td></tr> <tr><td>Poileitiléin</td><td></td></tr> </table>    | Bácaillt       |  | Níolón            |  | Poileitiléin |  |
| Níolón   |             |  |                     |  |                 |  |  |                |  |                   |  |              |  |
| Poileitiléin   |             |  |                     |  |                 |  |  |                |  |                   |  |              |  |
| PVC  |             |  |                     |  |                 |  |  |                |  |                   |  |              |  |
| Bácaillt   |             |  |                     |  |                 |  |  |                |  |                   |  |              |  |
| Níolón   |             |  |                     |  |                 |  |  |                |  |                   |  |              |  |
| Poileitiléin   |             |  |                     |  |                 |  |  |                |  |                   |  |              |  |
| <p>(iii) Nuair a théitear plaistigh theirmithéachtacha:</p> <table border="1" style="width: 100%; border-collapse: collapse;"> <tr><td>Bogann siad</td><td></td></tr> <tr><td>Éiríonn siad righin</td><td></td></tr> <tr><td>Scoilteann siad</td><td></td></tr> </table> | Bogann siad |  | Éiríonn siad righin |  | Scoilteann siad |  | <p>(vi) Is féidir bileog aicrileach a úsáid i ndéanamh:</p> <table border="1" style="width: 100%; border-collapse: collapse;"> <tr><td>Meaisínghardaí</td><td></td></tr> <tr><td>Málaí Plaisteacha</td><td></td></tr> <tr><td>Píopaí</td><td></td></tr> </table> | Meaisínghardaí |  | Málaí Plaisteacha |  | Píopaí       |  |
| Bogann siad  |             |  |                     |  |                 |  |  |                |  |                   |  |              |  |
| Éiríonn siad righin  |             |  |                     |  |                 |  |  |                |  |                   |  |              |  |
| Scoilteann siad  |             |  |                     |  |                 |  |  |                |  |                   |  |              |  |
| Meaisínghardaí   |             |  |                     |  |                 |  |  |                |  |                   |  |              |  |
| Málaí Plaisteacha  |             |  |                     |  |                 |  |  |                |  |                   |  |              |  |
| Píopaí   |             |  |                     |  |                 |  |  |                |  |                   |  |              |  |

(a) (i) Taispeáin le saighead treo gluaiseachta páirt 'X' i ngach ceann díobh seo a leanas:

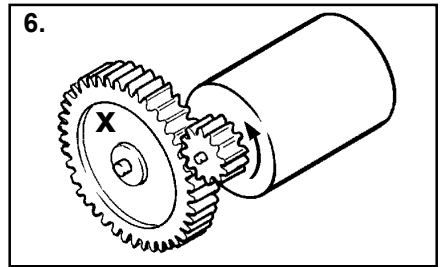
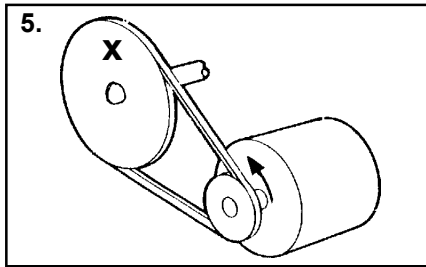
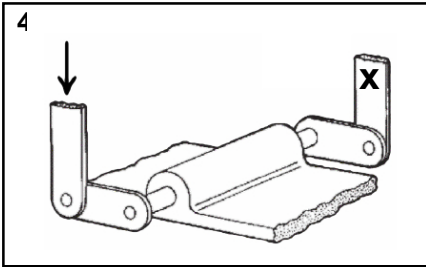
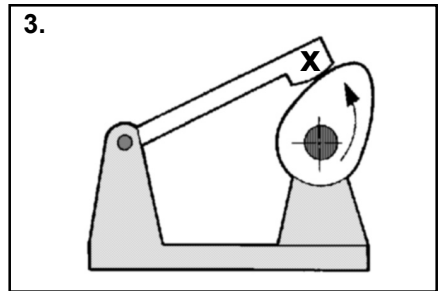
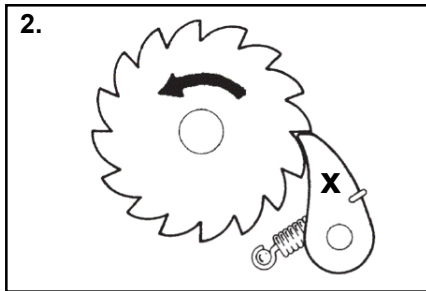
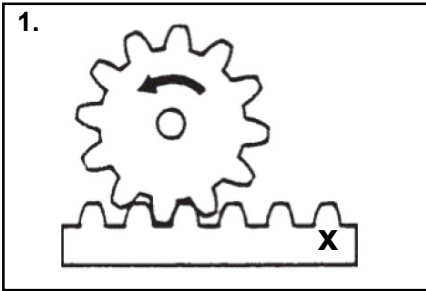

(ii) Cé acu ceann de na meicníochtaí seo ar raicín é?

Uimhir:

(b) (i) Is é is páirt 'X' ann ná:

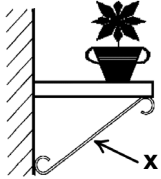

Snaidhmeán	<input type="checkbox"/>
Teanntóg	<input type="checkbox"/>
Stagh	<input type="checkbox"/>

(iv) Is é a thugtar ar phointe 'X' ná:

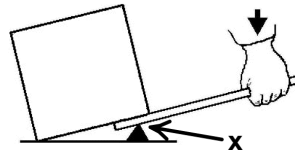

Luamhán	<input type="checkbox"/>
Buthal	<input type="checkbox"/>
Nascáil	<input type="checkbox"/>

(ii) An tiontú atá ag tarlú, is tiontú rothlach é go:

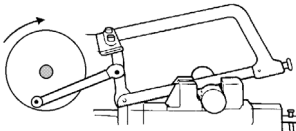

Líneach	<input type="checkbox"/>
Luascach	<input type="checkbox"/>
Frithingeach	<input type="checkbox"/>

(v) Dearthar struchtúir chun cé acu ceann díobh seo a iompar:



Ualaigh	<input type="checkbox"/>
Luamháin	<input type="checkbox"/>
Nascálacha	<input type="checkbox"/>

(iii) Is é an saghas fórsa a oibríonn 'X' ná:

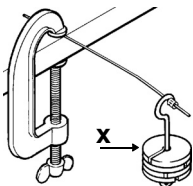

Fiarfhórsa	<input type="checkbox"/>
Fórsa Toirsiúnach	<input type="checkbox"/>
Fórsa Lúbach	<input type="checkbox"/>

(vi) Baineann coscáin chailipéir rothair úsáid as:

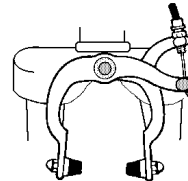

Cromáin chloig	<input type="checkbox"/>
Ulóga	<input type="checkbox"/>
Giaranna	<input type="checkbox"/>

(c) Ainmnigh meicníocht a úsáidtear i ngach ceann de na meaisíní seo.

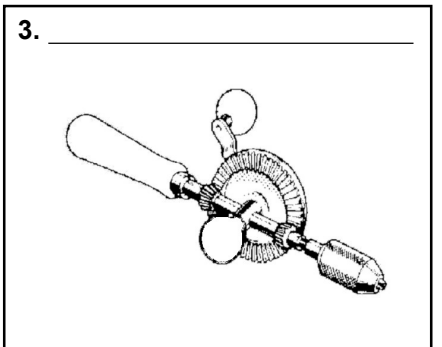
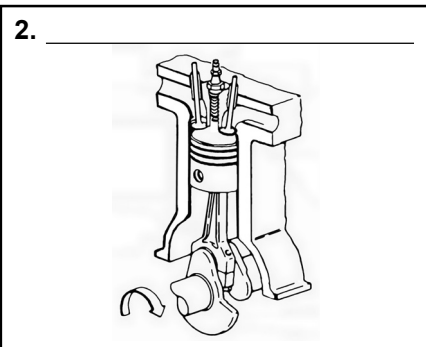
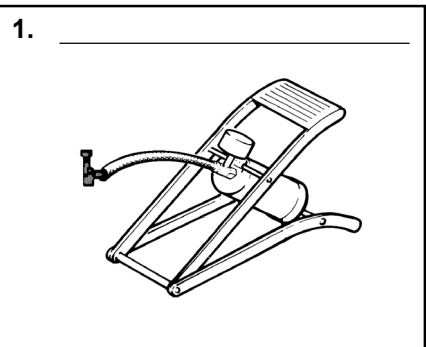

Taispeántar sonraí bracfráma a úsáidtear i monarú mionsamhail trucaile dumpála.

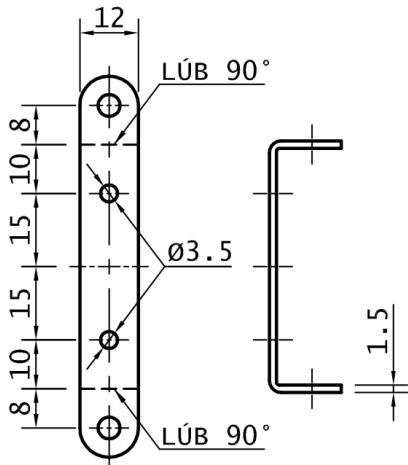

Bracfráma

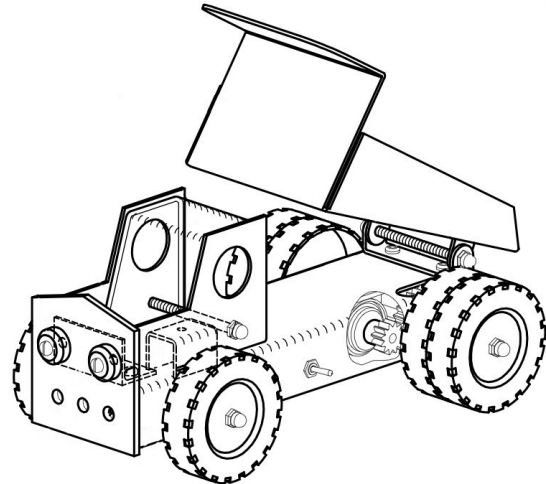

(i) Déan cur síos ar conas a mharcálfá go cruinn lár na bpoll druilire sa bhracfráma.

(ii) Cad é fad agus leithead iomlán an bhracfráma?

Fad:

Leithead:

(iii) Déan cur síos ar conas a lúbfá an bracfráma go cruinn.

(iv) Liostaigh **ceithre** uirlis a úsáidtear i monarú an bhracfráma.

1.	
2.	
3.	
4.	

(v) Déan cur síos ar conas a dhéanfá an seaimféar 2x45° ar an gceannlampa.

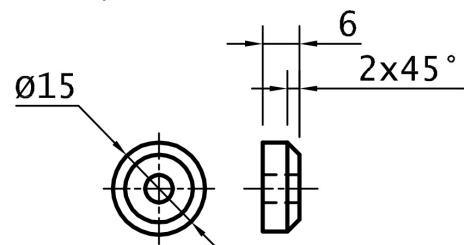
Ceannlampa

(vi) Cad iad na réamhchúraimí sábháilteachta ar cheart cloí leo nuair a a bhítear ag druileáil an bhracfráma?

(a) (i) Agus tú ag úsáid léaráid an chiorcaid mar thagairt, tarraing na sreanga cónaisc idir na comhphárteanna sa bhosca thíos.

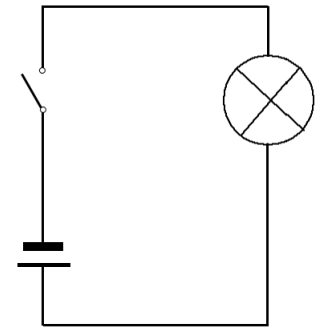
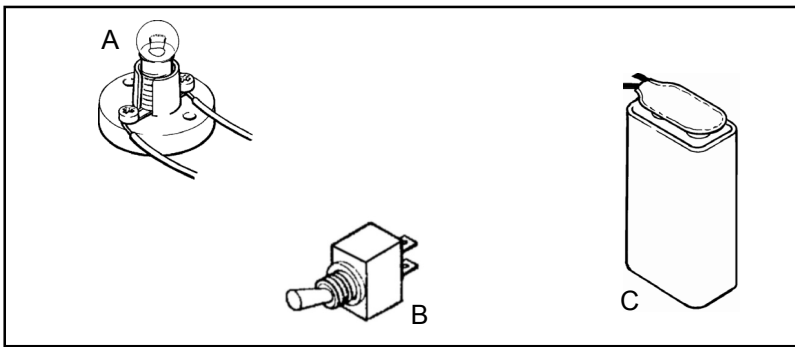

Léaráid Chiorcaid

(ii) Ainmnigh na comhphárteanna a thaispeántar thuas.

A	
B	
C	

(iii) An úsáideann an ciorcad seo sruth AC nó DC?

AC	
DC	

(b) (i) Tiontaíonn dordánaí fuinneamh leictreach i:

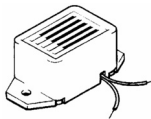

Fuinneamh Ceimiceach	
Fuinneamh Solais	
Fuinneamh Fuaimne	

(iv) Is é atá sa chomhpháirt seo ná:



LDR	
LED	
Fiús	

(ii) Tiontaíonn mótar fuinneamh leictreach i:

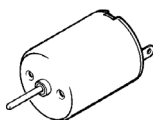

Fuinneamh Meicniúil	
Fuinneamh Ceimiceach	
Fuinneamh Solais	

(v) Is é is méarchlár ann ná:

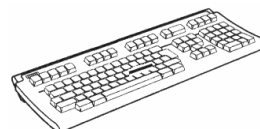

Gléas Aschurtha	
Gléas Ionchurtha	
Gléas Próisis	

(iii) Is é atá sa ghléas seo ná:

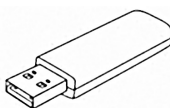

Tiomántán USB	
CD ROM	
Diosca Flapach	

(vi) Is é is printéir ann ná:



Gléas Aschurtha	
Gléas Ionchurtha	
Gléas Próisis	

(c) Ainmnigh **beirt** aireagóir i stair chúrsaí innealtóireachta agus abair a ndearna siad a thionscnamh.

Aireagóir 1

Ainm:	Aireagáin:

Aireagóir 2

Ainm:	Aireagáin:

