



**Cambridge International Examinations**  
Cambridge International General Certificate of Secondary Education

**PHYSICS**

**0625/21**

Paper 2 Multiple Choice (Extended)

**October/November 2018**

**45 minutes**

Additional Materials: Multiple Choice Answer Sheet  
Soft clean eraser  
Soft pencil (type B or HB recommended)

\* 8 2 0 7 6 3 1 2 0 9 \*

**READ THESE INSTRUCTIONS FIRST**

Write in soft pencil.

Do not use staples, paper clips, glue or correction fluid.

Write your name, Centre number and candidate number on the Answer Sheet in the spaces provided unless this has been done for you.

**DO NOT WRITE IN ANY BARCODES.**

There are **forty** questions on this paper. Answer **all** questions. For each question there are four possible answers **A, B, C** and **D**.

Choose the **one** you consider correct and record your choice in **soft pencil** on the separate Answer Sheet.

**Read the instructions on the Answer Sheet very carefully.**

Each correct answer will score one mark. A mark will not be deducted for a wrong answer.

Any rough working should be done in this booklet.

Electronic calculators may be used.

Take the weight of 1.0 kg to be 10 N (acceleration of free fall =  $10 \text{ m/s}^2$ ).

The syllabus is approved for use in England, Wales and Northern Ireland as a Cambridge International Level 1/Level 2 Certificate.

This document consists of **16** printed pages.

- 1 The diagram shows part of a micrometer screw gauge.

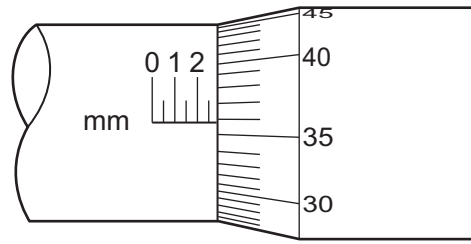

What is the smallest reading that can be achieved using this micrometer screw gauge?

- A** 0.0001 mm    **B** 0.01 mm    **C** 0.1 mm    **D** 1 mm
- 2 A small, light ball is dropped from the top of a tall building.

Which graph shows how the speed of the ball changes with time?

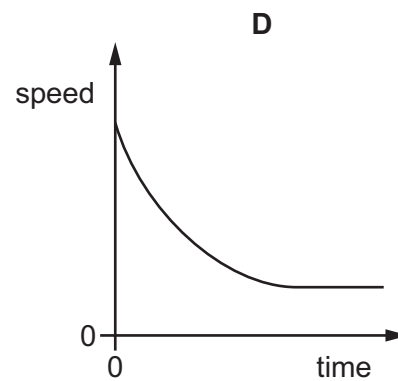
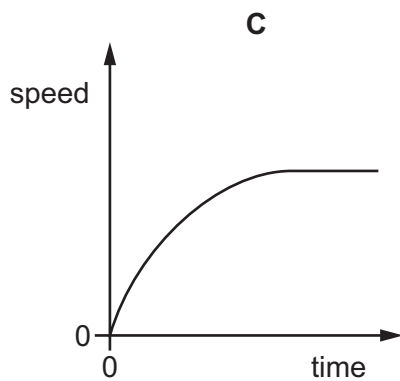
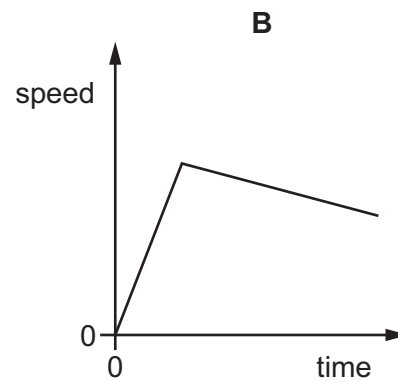
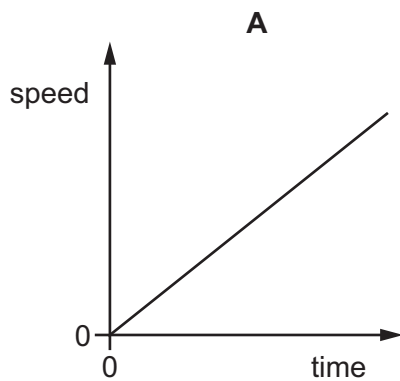

- 3 A runner runs 300 m at an average speed of 3.0 m/s. She then runs another 300 m at an average speed of 6.0 m/s.

What is her average speed for the total distance of 600 m?

- A** 2.0 m/s    **B** 4.0 m/s    **C** 4.5 m/s    **D** 8.0 m/s

- 4 A helium balloon is tied to a top-pan balance. A metal block of mass 100 g is placed on the balance. The reading on the balance is 91 g.

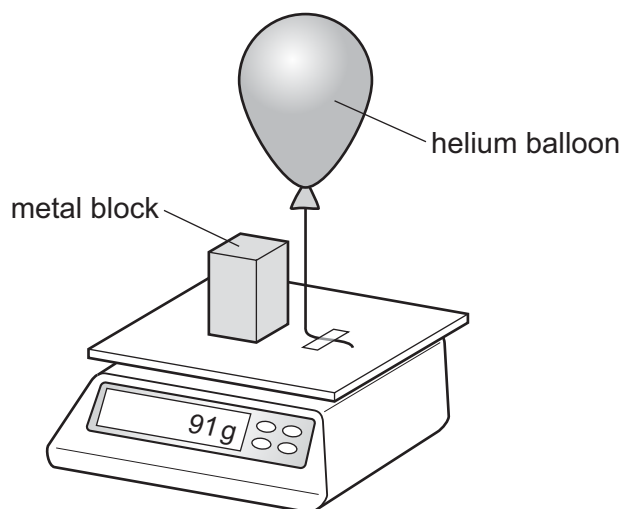

Which statement can be deduced from this experiment?

- A** The balloon exerts a downward force of 0.09 N on the top-pan balance.
- B** The helium has a mass of  $-9\text{ g}$ .
- C** The helium has a mass of  $+9\text{ g}$ .
- D** The resultant downward force on the top-pan balance is 0.91 N.
- 5 A liquid has a volume of  $0.040\text{ m}^3$  and a mass of 30 000 g.
- What is the density of the liquid?
- A**  $0.075\text{ kg/m}^3$     **B**  $7.5\text{ kg/m}^3$     **C**  $750\text{ kg/m}^3$     **D**  $7500\text{ kg/m}^3$
- 6 A resultant force of 4.0 N acts on an object of mass 0.50 kg for 3.0 seconds.
- What is the change in velocity caused by this force?
- A** 4.0 m/s    **B** 6.0 m/s    **C** 12 m/s    **D** 24 m/s
- 7 Which quantities are both vectors?
- A** acceleration and force
- B** acceleration and pressure
- C** density and force
- D** density and pressure

- 8 A moving ball with a momentum of  $25 \text{ kg m/s}$  collides head-on with a wall.

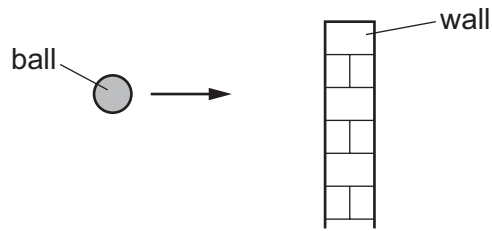

It rebounds from the wall with the same speed but in the opposite direction. The time of collision is  $50 \text{ ms}$ .

What is the average force exerted on the wall by the ball during the collision?

- A**  $0.50 \text{ N}$       **B**  $1.00 \text{ N}$       **C**  $500 \text{ N}$       **D**  $1000 \text{ N}$
- 9 Which device is designed to convert chemical energy into kinetic energy?
- A** an a.c. generator  
**B** a battery-powered torch  
**C** a car engine  
**D** a wind-up mechanical clock
- 10 An object, initially at rest, is dropped from a height of  $12.0 \text{ m}$ . The change in gravitational potential energy when it falls to the ground is  $565 \text{ J}$ .

The frictional forces are negligible.

What is its speed when it hits the ground?

- A**  $4.71 \text{ m/s}$       **B**  $15.5 \text{ m/s}$       **C**  $47.1 \text{ m/s}$       **D**  $240 \text{ m/s}$
- 11 A man climbs a ladder.

Which two quantities can be used to calculate the useful power of the man?

- A** the weight of the man and the time taken only  
**B** the weight of the man and the vertical distance moved only  
**C** the work done by the man and the time taken only  
**D** the work done by the man and the vertical distance moved only

12 A manometer is used to measure the pressure of a gas supply.

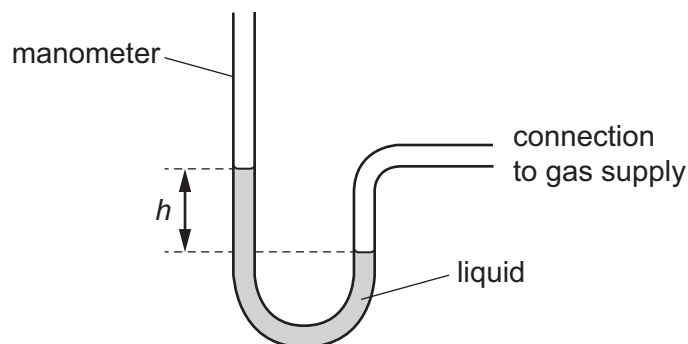

Which change gives a greater value of height  $h$ ?

- A using a less dense liquid
  - B using a more dense liquid
  - C using a narrower tube
  - D using a wider tube
- 13 A washbasin has an exit pipe covered with a plug of area  $12\text{ cm}^2$ . A chain is attached to the centre of the plug to assist in pulling the plug away from the exit hole. The washbasin contains water to a depth of  $0.080\text{ m}$ .

The density of the water is  $1000\text{ kg/m}^3$ .

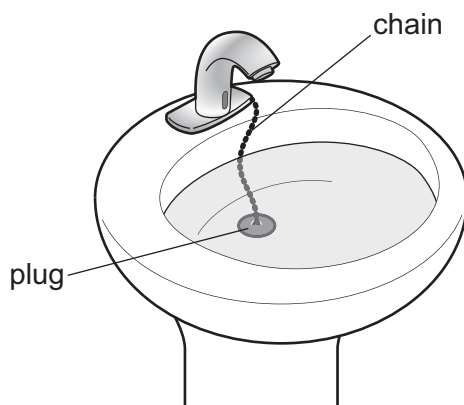

What is the force acting on the plug due to the water?

- A 0.96 N
- B 800 N
- C 9600 N
- D 80000 N

14 Diagram 1 shows apparatus being used to observe smoke particles.

Diagram 2 shows how a smoke particle moves randomly.

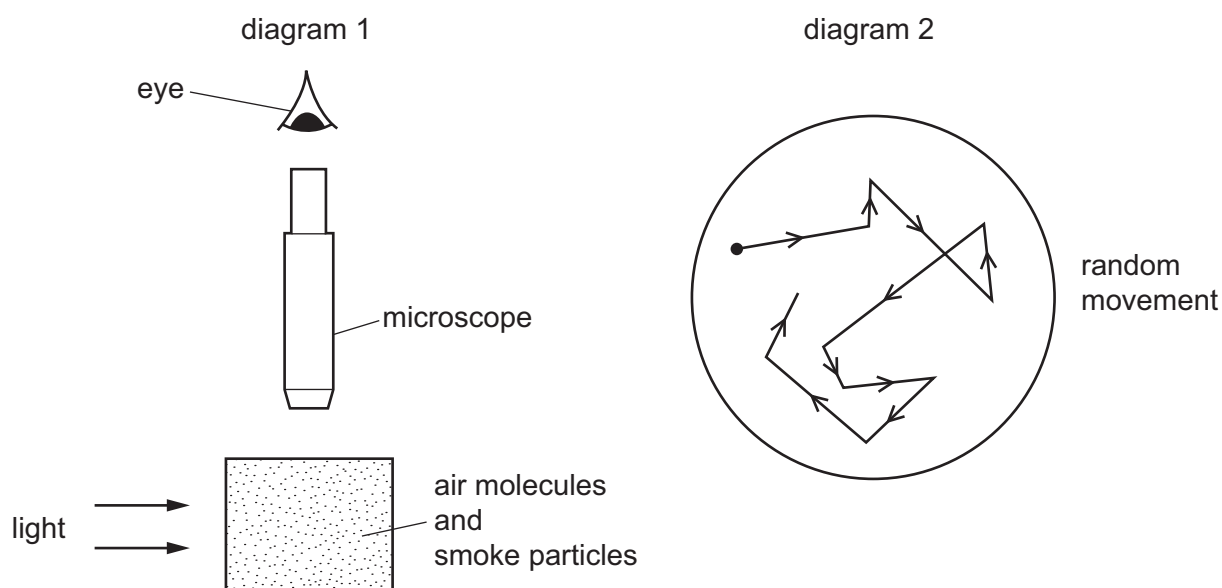

Why do the smoke particles move randomly?

- A They are hit by air molecules.
- B They are less dense than air.
- C They are moved by convection currents.
- D They gain energy from the light.

15 The gas in a sealed container is compressed at constant temperature.

Which graph shows how the pressure of the gas changes with its volume?

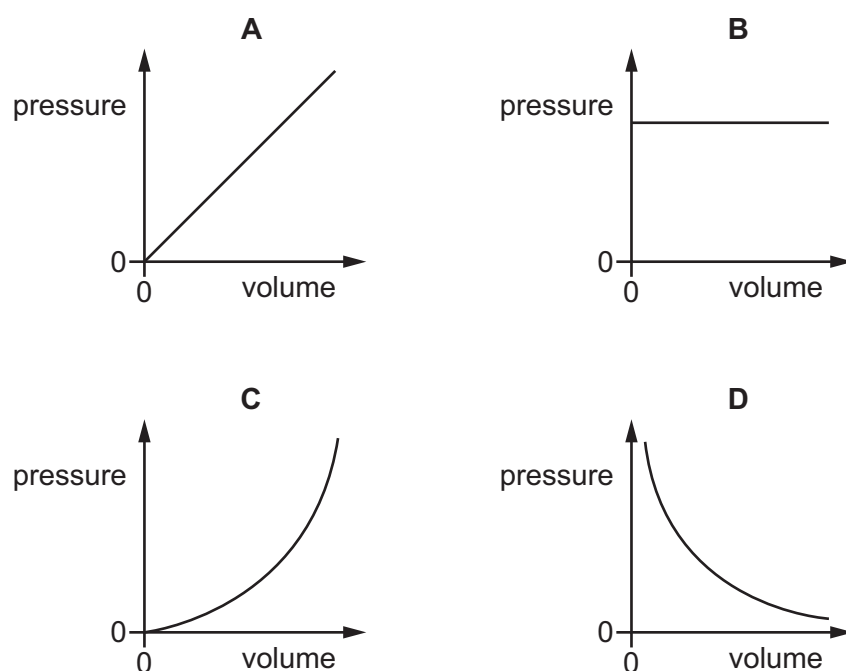

- 16 The distance between two electricity pylons is 60 m. An engineer fits a cable of length 62 m between the pylons.

Why does the engineer choose a cable that is longer than the distance between the two pylons?

- A to allow for contraction of the cable in cold weather
- B to create a slope in the cable for electrons to flow down
- C to keep the current low and the voltage high
- D to reduce magnetic fields around the cable

- 17 The diagram shows a liquid-in-glass thermometer.



Which change increases the sensitivity of the thermometer?

- A a narrower capillary tube
  - B a wider capillary tube
  - C thicker glass around the bulb
  - D thinner glass around the bulb
- 18 An object of mass 800 g and specific heat capacity  $250 \text{ J}/(\text{kg}^\circ\text{C})$  is heated. It absorbs 5300 J of energy.

What is the increase in temperature of the object?

- A  $0.027^\circ\text{C}$
  - B  $17^\circ\text{C}$
  - C  $27^\circ\text{C}$
  - D  $17\,000^\circ\text{C}$
- 19 On a cold day, a shiny metal rod feels colder to the touch than a black plastic rod.
- Which statement explains this observation?
- A The metal rod is a better absorber of infra-red radiation than the plastic rod.
  - B The metal rod is a better thermal conductor than the plastic rod.
  - C The metal rod is a worse absorber of infra-red radiation than the plastic rod.
  - D The metal rod is a worse thermal conductor than the plastic rod.

20 One end of a copper bar is heated to a high temperature.

Which mechanism is responsible for the transfer of thermal energy to the other end of the copper bar?

- A the lattice vibrations of copper ions only
- B the lattice vibrations of copper ions and the movement of high energy electrons along the bar
- C the movement of high energy copper ions along the bar
- D the movement of high energy electrons along the bar only

21 Plane water waves travel from a shallow region into a deeper region. They travel more quickly in the deeper water.

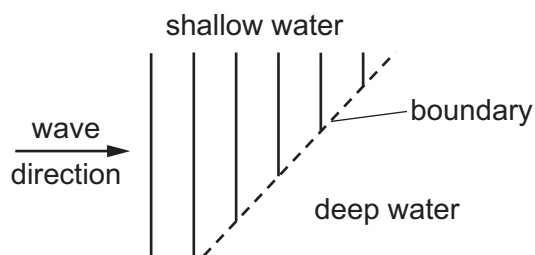

Which diagram shows the wave pattern in the deeper water?

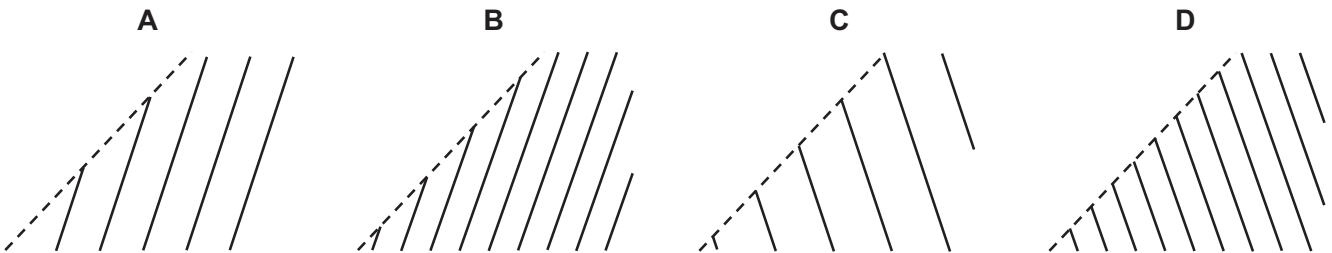

22 Which statement about the image formed by a plane mirror is correct?

- A The image is larger than the object.
- B The image is smaller than the object.
- C The image is twice as far from the mirror as the object.
- D The image is virtual.



- 23 A ray of light is incident on a glass-air surface. The diagrams show the ray of light at different angles of incidence in the glass.

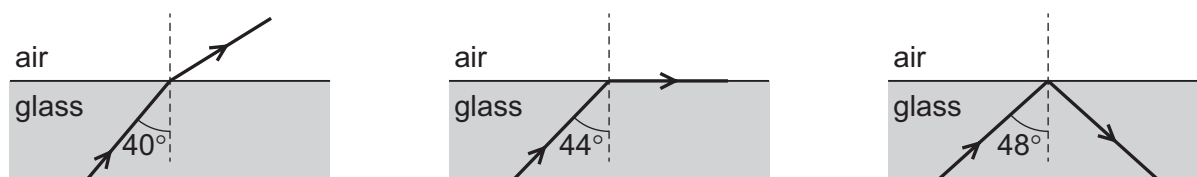

What is the refractive index of the glass?

- A** 1.35                      **B** 1.44                      **C** 1.50                      **D** 1.55
- 24 Different parts of the electromagnetic spectrum are used for different purposes. Below are four statements about parts of the spectrum.

statement 1: Infra-red waves are used in television remote controllers.

statement 2: Radio waves are used to transmit television pictures from satellites to Earth.

statement 3: Ultraviolet waves are used for intruder alarms.

statement 4: X-rays are used for security checks.

Which statements are correct?

- A** 1 and 2                      **B** 1 and 4                      **C** 2 and 3                      **D** 3 and 4
- 25 Iron is used for the core of a transformer and steel is used to make a bar magnet.

Which statement explains these uses of iron and of steel?

- A** Iron is a magnetic material and steel is a non-magnetic material.  
**B** Iron is a permanent magnetic material and steel is a temporary magnetic material.  
**C** Iron is a temporary magnetic material and steel is a permanent magnetic material.  
**D** Iron is a non-magnetic material and steel is a magnetic material.

- 26 A sheet of ice floats on water. A source of sound S is positioned at the edge of the ice sheet. Four microphones are placed equal distances from S. Which microphone detects the sound from S first?

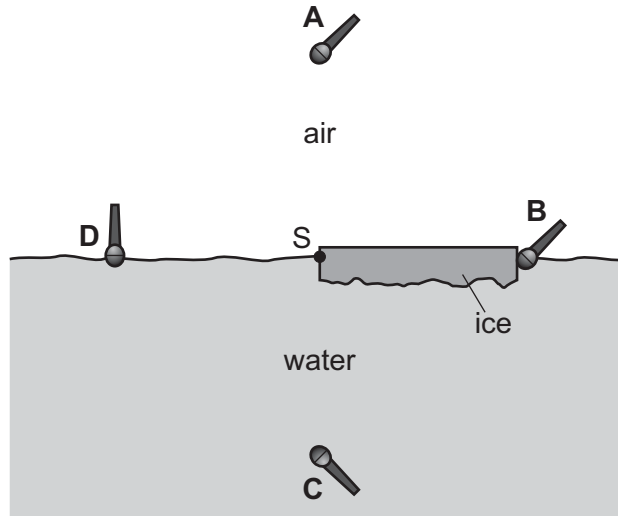

- 27 A bar magnet is placed inside a current-carrying coil. The diagram shows four different experiments. In which experiments is the magnet demagnetised?

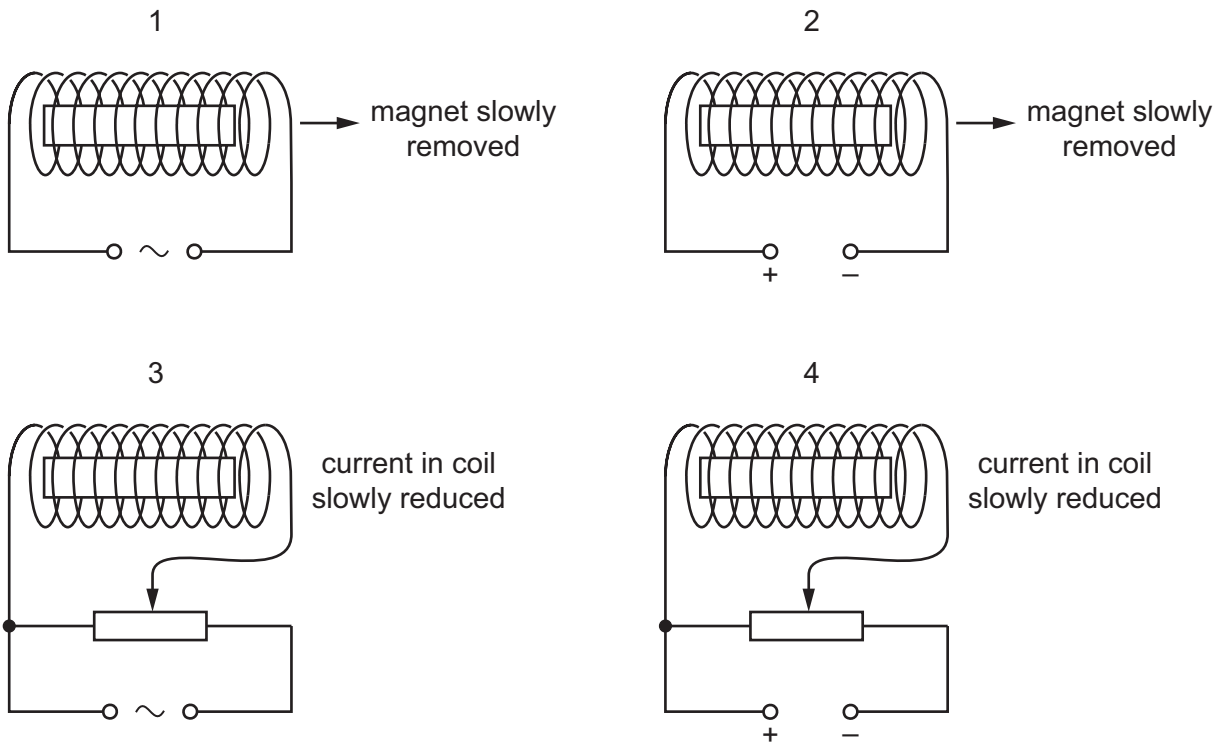

In which experiments is the magnet demagnetised?

- A 1 and 2      B 1 and 3      C 2 and 4      D 3 and 4



31 The circuit diagram shows a fixed resistor R and a thermistor T used in a potential divider circuit.

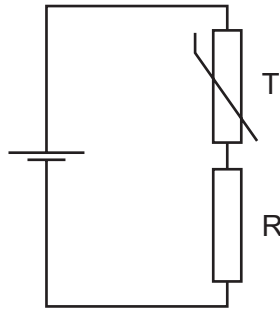

$V_R$  and  $V_T$  are the potential differences across R and T respectively.

What happens to  $V_R$  and to  $V_T$  as the temperature of the thermistor decreases?

	$V_R$	$V_T$
<b>A</b>	decreases	increases
<b>B</b>	increases	decreases
<b>C</b>	stays the same	decreases
<b>D</b>	stays the same	increases

32 The circuit diagram shows a power supply connected to some circuit components.

In the diagram, P and Q are the terminals of the d.c. power supply.

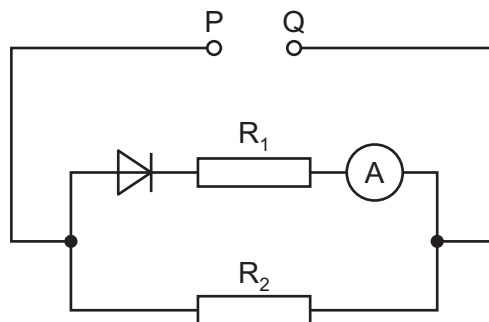

Under which circumstances does the ammeter show a reading other than zero?

- A** when P is positive or negative
- B** the ammeter always shows a zero reading
- C** only when P is negative
- D** only when P is positive

33 The diagram shows a digital circuit with two inputs and one output.

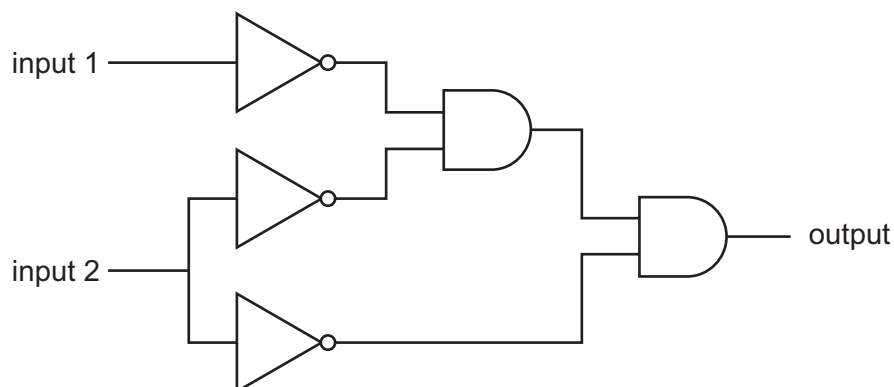

What describes the action of the circuit?

- A** AND                      **B** NAND                      **C** NOR                      **D** OR

34 Either a fuse or a circuit-breaker can be used to protect electrical cables from large currents that could cause overheating.

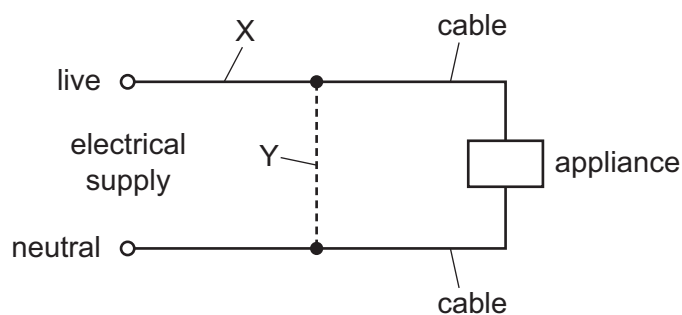

When a fuse is used, where should it be connected, and when a circuit-breaker is used, where should it be connected?

	position of fuse	position of circuit-breaker
<b>A</b>	X	X
<b>B</b>	X	Y
<b>C</b>	Y	X
<b>D</b>	Y	Y

35 There is a current of 3.0 A in a conductor.

The current is changed to 6.0 A in the opposite direction.

Which effect does this have on the magnetic field around the conductor?

- A It decreases and it acts in the opposite direction.
- B It decreases and it acts in the same direction.
- C It increases and it acts in the opposite direction.
- D It increases and it acts in the same direction.

36 A wire is placed in a strong magnetic field. When a current is passed through the wire it moves upwards, as shown.

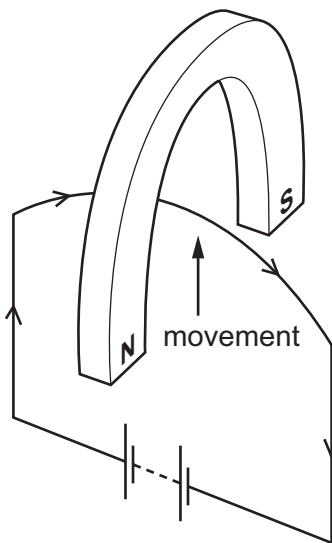

The current is reversed.

In which direction does the wire move?

- A downwards
- B towards the north pole
- C towards the south pole
- D upwards

37 Which diagram represents the structure of a neutral atom?

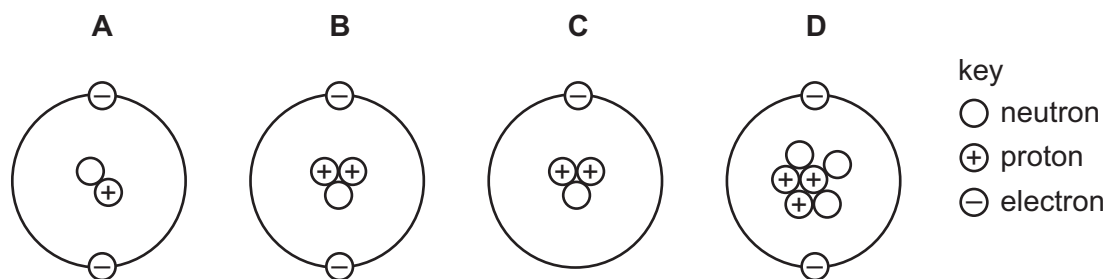

38 When a uranium-235 nucleus absorbs a neutron, it becomes unstable and undergoes fission.

The fission process produces a barium (Ba) nucleus, a krypton (Kr) nucleus and 3 neutrons.

The fission process is represented by the nuclear equation shown.

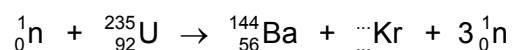

Which symbol represents the resulting krypton nucleus?

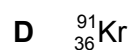
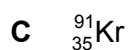
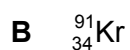
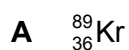

39 The diagram shows the paths of three different types of radiation X, Y and Z.

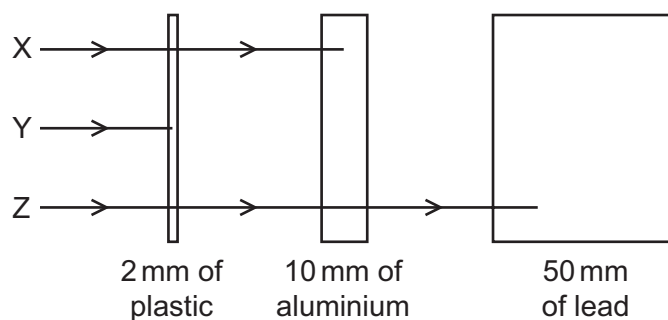

Which row correctly identifies X, Y and Z?

	X	Y	Z
<b>A</b>	$\alpha$ -particles	$\beta$ -particles	$\gamma$ -rays
<b>B</b>	$\beta$ -particles	$\alpha$ -particles	$\gamma$ -rays
<b>C</b>	$\beta$ -particles	$\gamma$ -rays	$\alpha$ -particles
<b>D</b>	$\gamma$ -rays	$\alpha$ -particles	$\beta$ -particles

- 40 A scientist measures the count rate of a radioactive sample in a laboratory over a period of 12 weeks.

The background radiation count rate in the laboratory remains constant at 20 counts per minute.

The table shows the scientist's results before the background radiation count rate is taken into account.

time /weeks	count rate /counts per minute
0	100
2	80
4	65
6	54
8	45
10	39
12	34

In which range does the half-life of the radioactive isotope lie?

- A between 4 and 6 weeks
- B between 6 and 8 weeks
- C between 8 and 10 weeks
- D more than 12 weeks

---

Permission to reproduce items where third-party owned material protected by copyright is included has been sought and cleared where possible. Every reasonable effort has been made by the publisher (UCLES) to trace copyright holders, but if any items requiring clearance have unwittingly been included, the publisher will be pleased to make amends at the earliest possible opportunity.

To avoid the issue of disclosure of answer-related information to candidates, all copyright acknowledgements are reproduced online in the Cambridge International Examinations Copyright Acknowledgements Booklet. This is produced for each series of examinations and is freely available to download at [www.cie.org.uk](http://www.cie.org.uk) after the live examination series.

Cambridge International Examinations is part of the Cambridge Assessment Group. Cambridge Assessment is the brand name of University of Cambridge Local Examinations Syndicate (UCLES), which is itself a department of the University of Cambridge.