



UNIVERSITY OF CAMBRIDGE INTERNATIONAL EXAMINATIONS
International General Certificate of Secondary Education

CANDIDATE
NAME

CENTRE
NUMBER

--	--	--	--	--

CANDIDATE
NUMBER

--	--	--	--	--

* 1 2 6 4 2 4 0 1 9 5 *

PHYSICAL SCIENCE

0652/61

Paper 6 Alternative to Practical

October/November 2012

1 hour

Candidates answer on the Question Paper.

No Additional Materials are required.

READ THESE INSTRUCTIONS FIRST

Write your Centre number, candidate number and name on all the work you hand in.

Write in dark blue or black pen.

You may use a soft pencil for any diagrams or graphs.

Do not use staples, paper clips, highlighters, glue or correction fluid.

DO NOT WRITE IN ANY BARCODES.

Answer **all** questions.

At the end of the examination, fasten all your work securely together.

The number of marks is given in brackets [] at the end of each question or part question.

For Examiner's Use	
1	
2	
3	
4	
5	
6	
Total	

This document consists of **22** printed pages and **2** blank pages.



- 1 A science teacher is showing the class some experiments using a radioactive source. She is using a Geiger-Muller tube and a scaler to measure the amount of radiation emitted by the source. The scaler shows the count. The apparatus is shown in Fig. 1.1.

A piece of paper or metal may be placed at position **X** for the radiation to pass through. A radiation shield is used to protect the class.

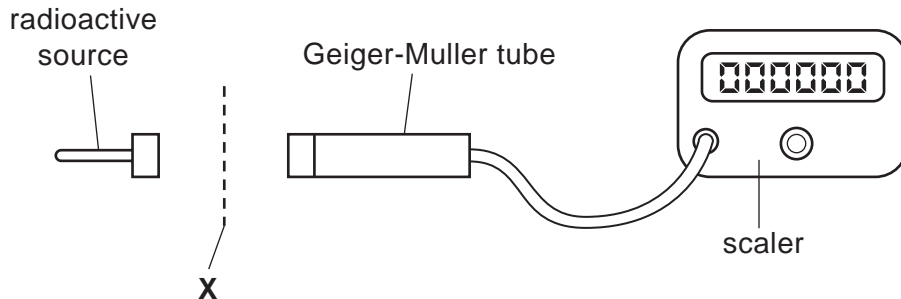

Fig. 1.1

- The teacher switches on the apparatus and finds the count for 20 seconds. She does not place anything at position **X**. Fig. 1.2 shows the scaler reading.
- The teacher places a sheet of paper at position **X**, then switches on the tube and scaler for another 20 seconds. Fig. 1.3 shows the scaler reading.
- The teacher places a thick sheet of aluminium at position **X** and switches on the tube and scaler for another 20 seconds. Fig. 1.4 shows the scaler reading.



air

Fig. 1.2



paper

Fig. 1.3



aluminium

Fig. 1.4

Table 1.1

radiation passes through	number of counts in 20 seconds	counts per second
air		
paper		
aluminium		

- (a) (i) Read the scalers in Figs. 1.2, 1.3 and 1.4 and complete column 2 of Table 1.1. [1]
- (ii) Calculate the counts per second and complete the third column of Table 1.1. [1]

(b) The radioactive source used is an isotope of radium, ${}^{226}_{88}\text{Ra}$. It gives off alpha and beta particles, and gamma rays.

(i) State the types of radiation that are stopped by the aluminium.

..... and [2]

(ii) Suggest what could be placed at position X to stop all three types of radiation.

..... [1]

(c) (i) The teacher holds a magnet close to the path of the radiation coming out of the radioactive source, see Fig. 1.5. The count shown by the scaler is lower when she does this because some of the radiation is deflected.

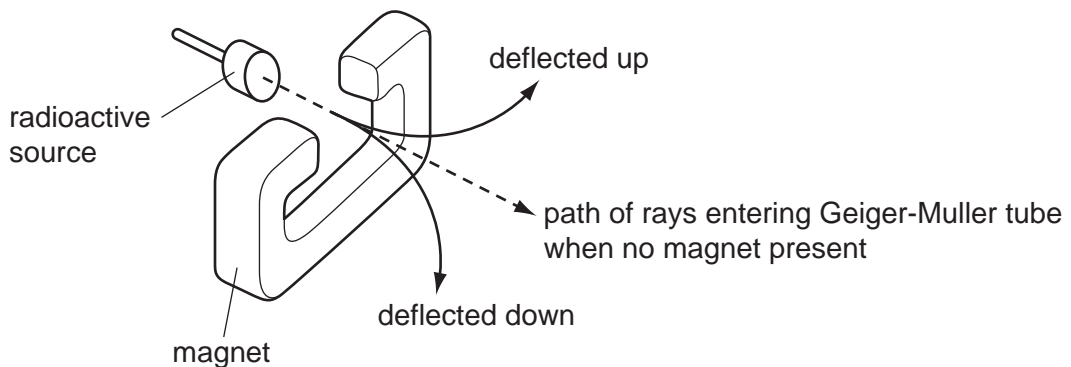

Fig. 1.5

State the types of radiation that are deflected by the magnetic field.

..... and [1]

(ii) The teacher tells the class that one of the two types of radiation deflected by the magnet is deflected **upward**, and the other one is deflected **downward**.

Explain why these two types of radiation are deflected in opposite directions by the magnetic field.

.....

 [2]

Fig. 1.6 shows the decay curve for the $^{226}_{88}\text{Ra}$ isotope.

For
Examiner's
Use

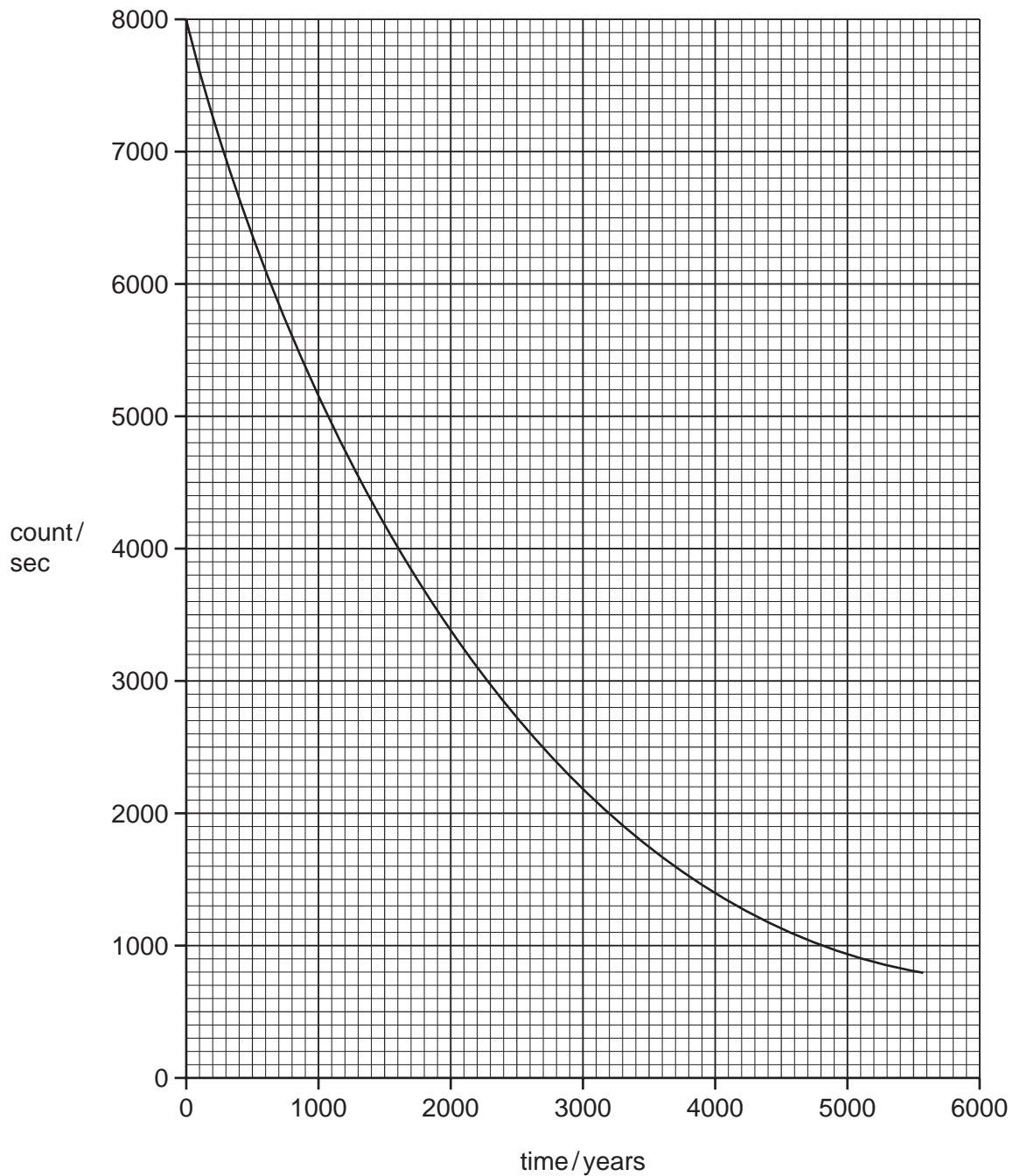

Fig. 1.6

(d) Use the decay curve shown in Fig. 1.6 to find the half-life of $^{226}_{88}\text{Ra}$. Show how you do this by drawing lines on the graph.

half-life of $^{226}_{88}\text{Ra}$ = years [2]

Please turn over for Question 2.

- 2 A student is doing an experiment to find the mass of a metre rule. He rests the rule on the pivot at the 40 cm mark.

He hangs a 100g load at the 10cm mark of the ruler. He hangs a balancing mass, $m = 50\text{g}$, on the other side of the rule so that the rule balances, see Fig. 2.1. The balancing mass is d cm from the pivot.

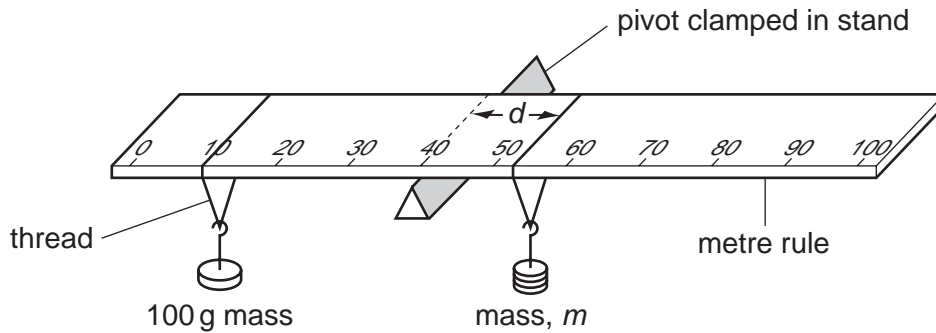

Fig. 2.1

- The student finds distance, d , and records it in Table 2.1.
- He adds 10g to the balancing mass, m , and adjusts its position so that the rule balances.
- He finds the new distance, d , and records it in Table 2.1.
- He repeats this procedure using balancing masses, m , of 70, 80 and 90g.

Table 2.1

mass, m/g	distance, d/cm	$\frac{1}{m}/\frac{1}{g}$
50	34.6	0.020
60	28.8	0.017
70		
80	21.9	0.013
90		

- (a) (i) Figs. 2.2 and 2.3 show the scale of the rule and the positions of the balancing masses when $m = 70\text{ g}$ and $m = 90\text{ g}$.

For
Examiner's
Use

Read and record below the scale of the rule for each mass.

scale reading for 70 g mass = cm

scale reading for 90 g mass = cm

[2]

- (ii) Use your answers to (i) to calculate the values of d for each mass.

Record your values of d in Table 2.1.

[1]

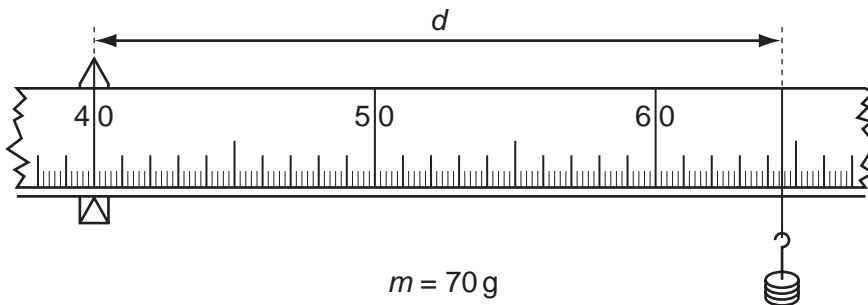

Fig. 2.2

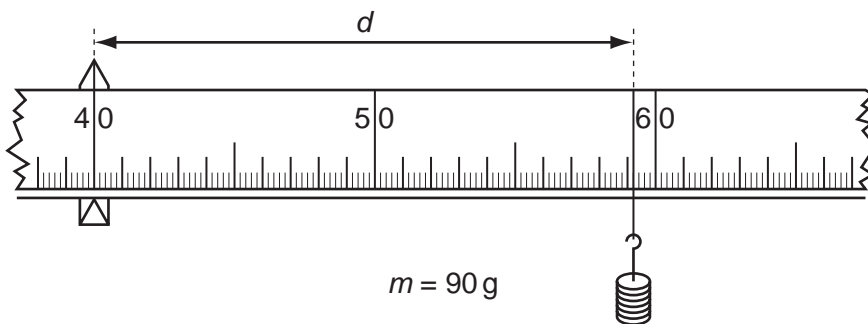

Fig. 2.3

- (iii) Calculate, to three decimal places, the values of $\frac{1}{m}$ for the masses 70 g and 90 g.
Record these values in Table 2.1.

[2]

- (b) (i) On the graph grid provided, plot distance, d , (vertical axis) against $\frac{1}{m}$.

For
Examiner's
Use

Draw the best straight line.

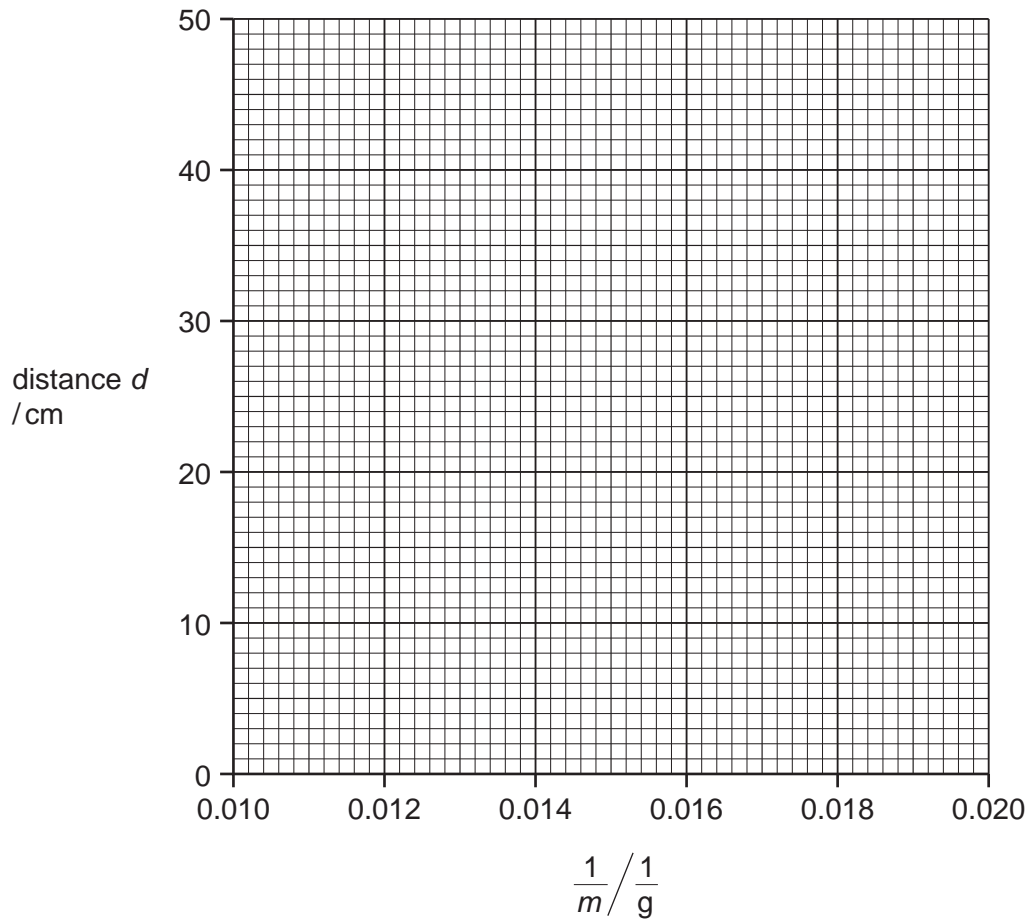

[2]

- (ii) Find the gradient of the straight line you have drawn. Show clearly on the graph how you obtain the values used to calculate the gradient.

gradient = [2]

(c) Calculate the mass of the rule using the formula

$$\text{mass of rule} = 300 - \frac{\text{gradient}}{10} .$$

*For
Examiner's
Use*

mass of the ruler = g [1]

- 3 A farmer's bean crop is poor. He thinks that the soil in his field may be too acidic. He gives a science student three samples, **A**, **B** and **C** of the soil for testing.

For
Examiner's
Use

There are two parts to the tests.

Part 1

The student takes some of sample **A** and mixes it with water. He separates the water from the soil by filtering the mixture. This gives soil washing **A**.

He repeats this procedure to give soil washings **B** and **C**.

- (a) Suggest **one** practical detail of this procedure that enables a fair comparison of the three soil samples.

.....

.....

..... [1]

Part 2

The student wants to find out what volume of soil washing **A** is needed to neutralise 10 cm^3 of aqueous calcium hydroxide solution. See Fig. 3.1.

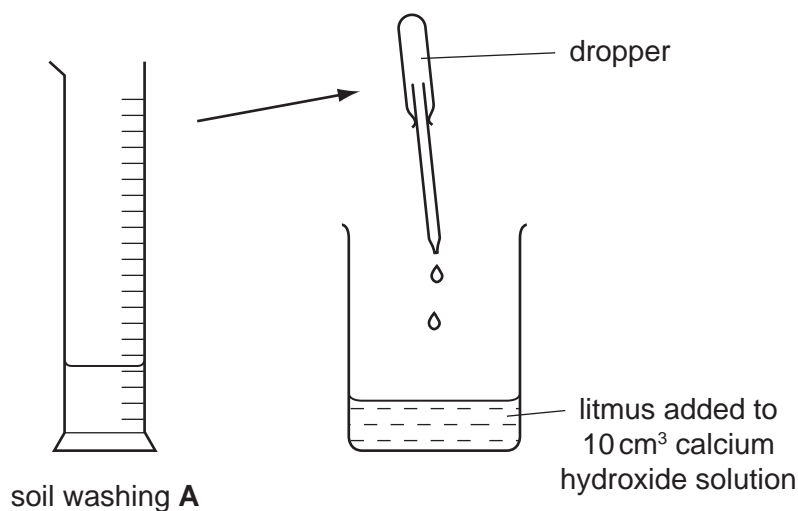

Fig. 3.1

- He places 10 cm^3 of calcium hydroxide solution in a beaker and adds a few drops of litmus.
- He places 10 cm^3 soil washing **A** in a measuring cylinder.
- He uses a dropper to add soil washing **A** from the measuring cylinder, drop by drop, to the calcium hydroxide in the beaker, until the litmus changes colour.
- He notes how much soil washing **A** is left in the measuring cylinder and records the volume in Table 3.1.
- He repeats this procedure with soil washings **B** and **C**.

(b) State the colour change of the litmus.

from to [2]

Fig. 3.2 shows the scales of the measuring cylinder containing soil washings **A**, **B** and **C** after the litmus has changed colour.

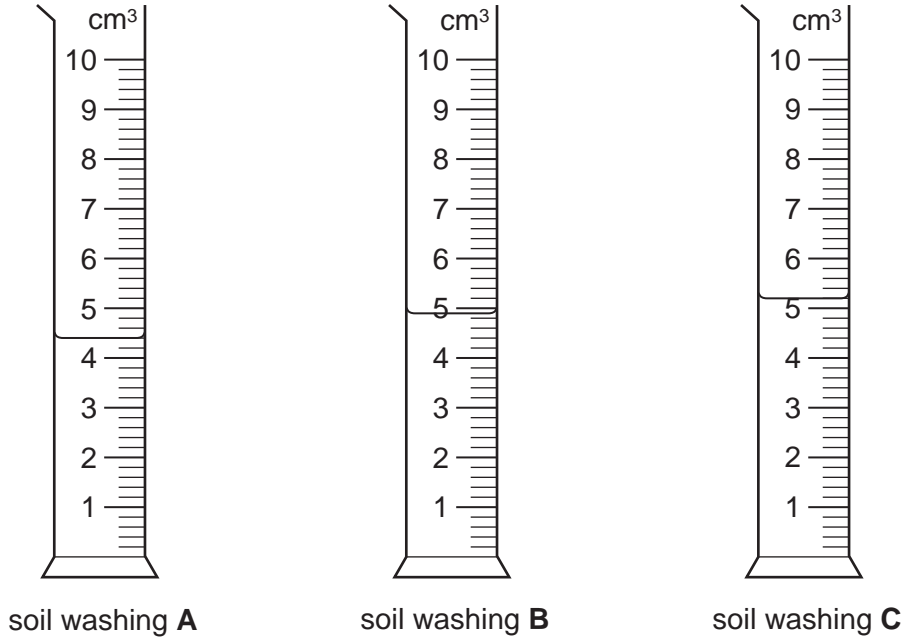

Fig. 3.2

(c) (i) Read the volumes left in the measuring cylinders and record them in Table 3.1. [3]

(ii) Calculate the volumes of soil washings **A**, **B** and **C** added to the calcium hydroxide solution. Record them in Table 3.1. [1]

Table 3.1

soil washing	volume left in measuring cylinder/cm ³	volume of soil washings added/cm ³
A		
B		
C		

Use data from the third column of Table 3.1 to calculate the average volume, V_{av} , of the soil washings added.

$V_{av} = \dots\dots\dots$ cm³ [1]

(d) The concentration of the calcium hydroxide solution is 0.013 mol/dm^3 .

Using the equation given, calculate the concentration of the acid in the soil washings.

$$\text{concentration of acid} = \frac{(2 \times 0.013 \times 10)}{V_{\text{av}}}$$

concentration of acid = mol/dm^3 [1]

The farmer can decide how much calcium hydroxide (lime) to put on his field.

If he adds too much lime so that the soil becomes alkaline, plants cannot absorb the ions of essential trace metals such as iron, magnesium and zinc because they become insoluble.

(e) Suggest why these ions become insoluble in alkaline soils.

.....
..... [1]

For
Examiner's
Use

Please turn over for Question 4.

- 4 A student is doing an experiment to find out how varying the surface area of magnesium ribbon affects its rate of reaction with dilute hydrochloric acid.

For
Examiner's
Use

Fig. 4.1 shows the apparatus he is using.

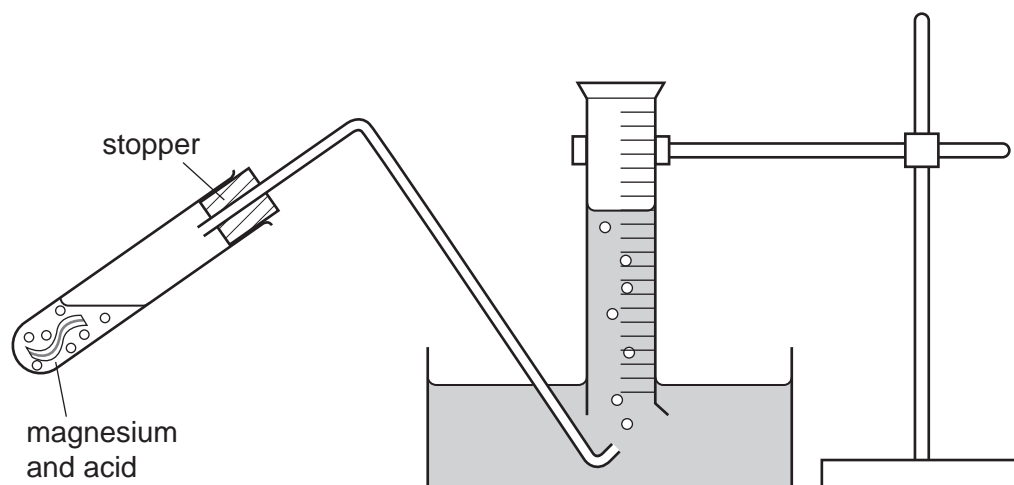

Fig. 4.1

- He cuts a piece of magnesium ribbon.
- He places 15 cm^3 of dilute hydrochloric acid in the test-tube.
- He adds the piece of magnesium to the acid, replaces the stopper and starts the stopclock.
- He records in Table 4.1 the volume of hydrogen collected during the first 1 minute of the reaction.
- He repeats the experiment using a fresh 15 cm^3 of acid and two pieces of magnesium the same size as the first one.
- He repeats the experiment using three and then four pieces of magnesium.

Table 4.1

number of pieces of magnesium	volume of hydrogen collected in 1 minute / cm^3
1	25
2	
3	
4	120

- (a) Fig. 4.2 shows the measuring cylinder scales for the volume of hydrogen collected after 1 minute using 2 and 3 pieces of magnesium. Record the volumes in Table 4.1.

For
Examiner's
Use

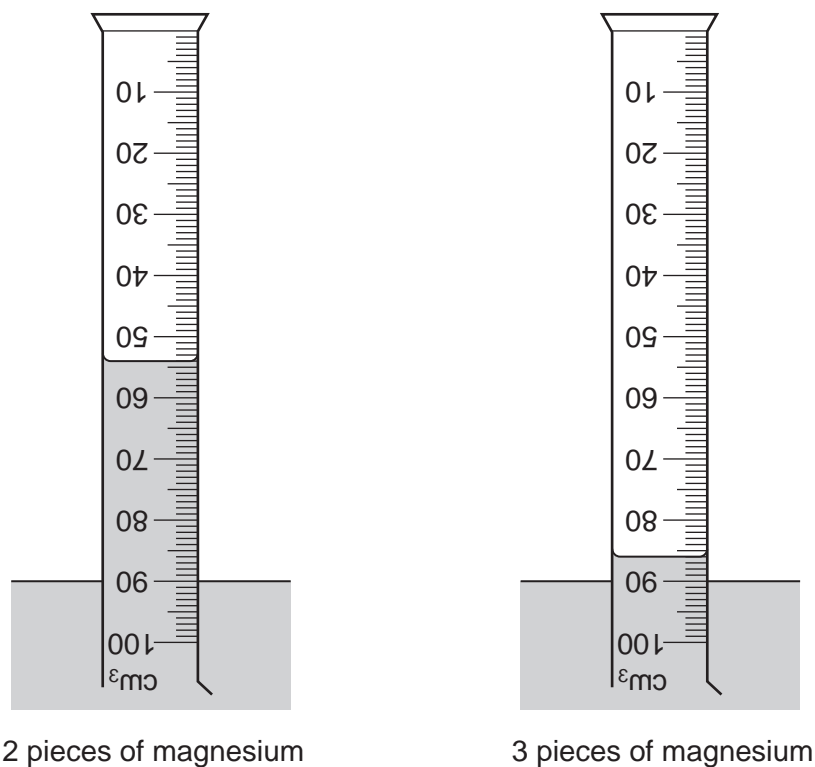

Fig. 4.2

[2]

- (b) (i) Fig. 4.3 shows the actual size of one piece of magnesium that the student is using.



Fig. 4.3

Measure the length and width of the piece of magnesium to the nearest millimetre.

length = cm width = cm [2]

- (ii) Calculate the surface area of the magnesium strip. Remember that the magnesium strip has two sides. Ignore the thickness of the strip.

surface area of one piece of magnesium = cm² [2]

- (c) Calculate the volume of hydrogen given off in one minute from 1 cm² area of the magnesium strip. Use the data from the first row of Table 4.1.

For
Examiner's
Use

volume of hydrogen given off in one minute = cm³ [2]

- (d) The student notices that the volume of hydrogen given off in one minute from 4 pieces of magnesium is greater than 4 x (the volume given off from 1 piece of magnesium).

He decides that the reaction rate must have speeded up.

The reaction between hydrochloric acid and magnesium is exothermic.

Explain why the reaction rate speeds up when 4 pieces of magnesium are used.

.....
.....
.....
..... [2]

- 5 A student was given five bottles, labelled **A – E**. Each bottle contains one of the following solutions: sodium carbonate, sodium chloride, sodium hydroxide, sodium nitrate and sodium sulfate.

*For
Examiner's
Use*

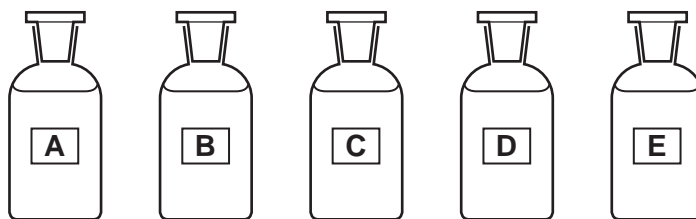

Fig. 5.1

The student used the Test Plan, Fig. 5.2, shown on page 18 to identify the solutions. He carried out four tests on the solutions, recorded his observations and named the solutions.

On the Test Plan, some of the student's work has been deleted.

Study the Test Plan over the page and then answer the questions that follow it.

Do not write anything on page 18.

Do not write anything on this page.

For
Examiner's
Use

TEST PLAN

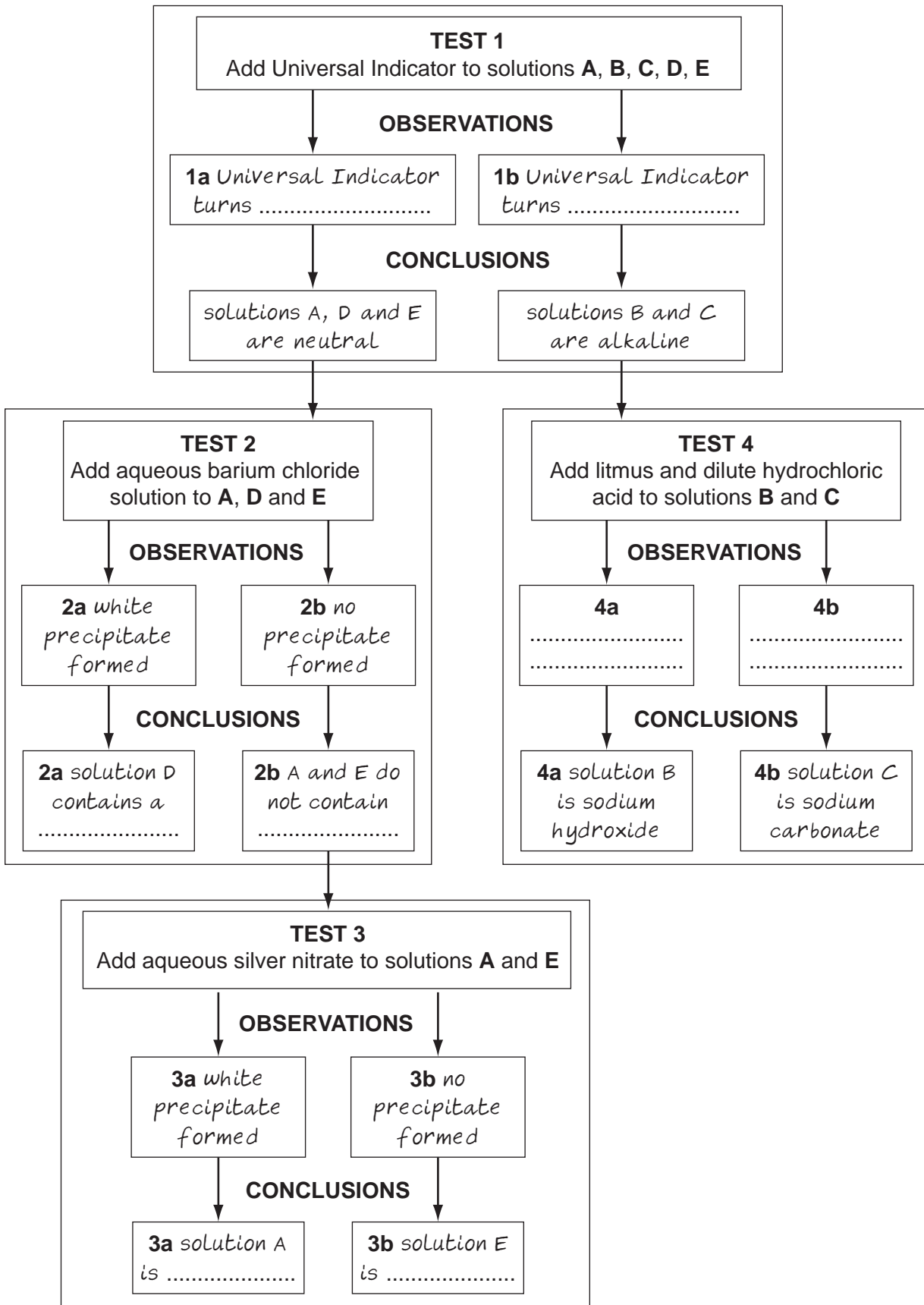

Fig. 5.2

(a) The student added Universal Indicator to the five solutions. Use the conclusion for **Test 1** in the test plan to help you to write **observations 1a** and **1b**.

observation 1a: Universal Indicator turned

observation 1b: Universal Indicator turned [2]

(b) In **Test 2**, the student added aqueous barium chloride solution to solutions **A**, **D** and **E**. He recorded **observation 2a** and **observation 2b**. Then he named liquid **D**.

Suggest the name of liquid **D** [1]

(c) In **Test 3**, the student added aqueous silver nitrate to solutions **A** and **E**. He recorded **observation 3a** and **observation 3b**. These observations helped him name solutions **A** and **E**.

Suggest the name of solution **A**

Suggest the name of solution **E** [2]

(d) In **Test 4** the student added litmus solution followed by dilute hydrochloric acid to solutions **B** and **C** until there was no further reaction. He recorded **observation 4a** and **observation 4b**.

He concluded that solution **B** is sodium carbonate, and solution **C** is sodium hydroxide.

(i) What did the student record for **observation 4a**?

.....
..... [1]

(ii) What did the student record for **observation 4b**?

.....
..... [2]

(e) (i) Name the white precipitate seen in **Test 2**.

white precipitate [1]

(ii) Explain what is meant by a *precipitate*.

.....
..... [1]

- 6 The science teacher has given a student a filament lamp that is made for use with a 240 volt electricity supply.

The filament of the lamp is made from tungsten, a metal that has a very high melting point. The filament glows white hot when current passes through it using a 240 volt supply.

The resistance of tungsten metal is altered when its temperature is changed.

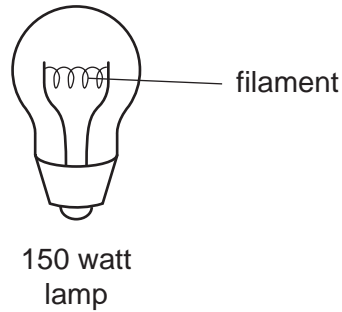

Fig. 6.1

- (a) (i) Complete the sentence to show the main energy changes that occur when the lamp is switched on.

electrical energy → and [2]

- (ii) What gas is contained in the lamp to prevent the filament burning out when it becomes very hot?

..... [1]

The student connects the lamp in the circuit shown in Fig. 6.2. An ammeter, **A**, is used to find the current and a voltmeter, **V**, is used to find the applied voltage.

For
Examiner's
Use

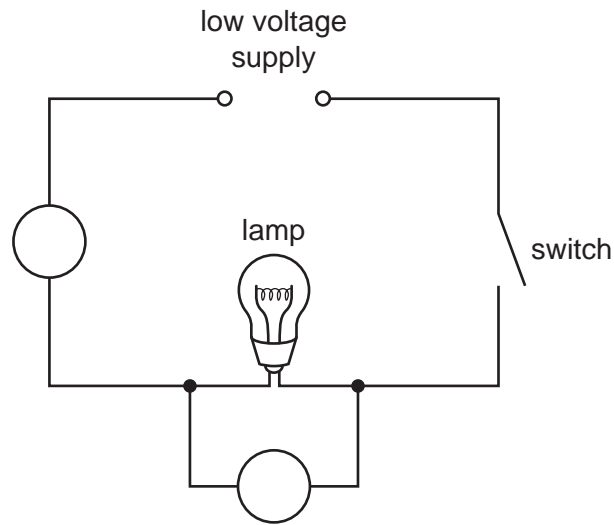

Fig. 6.2

- (b) To show where the ammeter and voltmeter should be placed in the circuit, write **A** and **V** in the correct places on Fig. 6.2. [1]

The student closes the switch. The lamp does not light up, but the meters show readings. The ammeter reading immediately reaches a maximum.

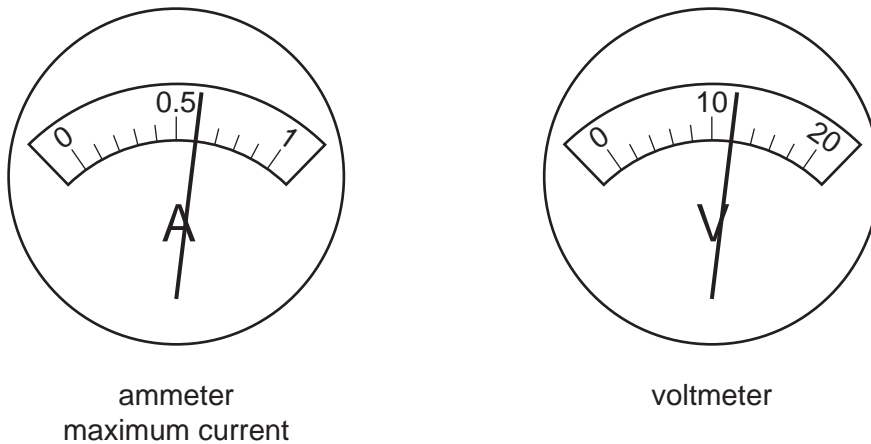

Fig. 6.3

- (c) Read the meters in Fig. 6.3 to the nearest 0.1 amp and 1 volt and record the readings in Table 6.1. [2]

Table 6.1

maximum current / A	applied voltage / V

- (d) (i)** The lamp uses 150 watts of power when 240 volts is applied and the lamp is shining brightly.

Calculate the current passing through the lamp when it shines brightly.

Use the formula

$$\text{current in amps} = \frac{\text{power in watts}}{\text{applied voltage}}$$

current passing through the lamp = A [1]

- (ii)** Compare the voltage and current shown in Table 6.1 and your answer to **(d)(i)**.

Suggest how the resistance of the tungsten filament changes when the filament is glowing brightly.

.....
 [1]

- (e)** European governments do not allow shops to sell filament lamps for use in homes. This is because more efficient lamps are available, such as fluorescent lamps.

Explain why the use of filament lamps is an inefficient way to produce light and how their use contributes to global warming.

.....

 [2]

For
Examiner's
Use

BLANK PAGE

Permission to reproduce items where third-party owned material protected by copyright is included has been sought and cleared where possible. Every reasonable effort has been made by the publisher (UCLES) to trace copyright holders, but if any items requiring clearance have unwittingly been included, the publisher will be pleased to make amends at the earliest possible opportunity.

University of Cambridge International Examinations is part of the Cambridge Assessment Group. Cambridge Assessment is the brand name of University of Cambridge Local Examinations Syndicate (UCLES), which is itself a department of the University of Cambridge.