



UNIVERSITY OF CAMBRIDGE INTERNATIONAL EXAMINATIONS
International General Certificate of Secondary Education

www.XtremePapers.com

PHYSICAL SCIENCE

0652/12

Paper 1 Multiple Choice

October/November 2011

45 minutes

Additional Materials: Multiple Choice Answer Sheet
Soft clean eraser
Soft pencil (type B or HB is recommended)

* 3 7 4 5 5 0 5 1 2 8 *

READ THESE INSTRUCTIONS FIRST

Write in soft pencil.

Do not use staples, paper clips, highlighters, glue or correction fluid.

Write your name, Centre number and candidate number on the Answer Sheet in the spaces provided unless this has been done for you.

There are **forty** questions on this paper. Answer **all** questions. For each question there are four possible answers **A, B, C** and **D**.

Choose the **one** you consider correct and record your choice in **soft pencil** on the separate Answer Sheet.

Read the instructions on the Answer Sheet very carefully.

Each correct answer will score one mark. A mark will not be deducted for a wrong answer.

Any rough working should be done in this booklet.

A copy of the Periodic Table is printed on page 20.

This document consists of **19** printed pages and **1** blank page.



- 1 The following statements are about covalent bonding.

Covalent bonds are formed by the1..... of electrons.

Covalent substances have2..... electrical conductivity.

Which words correctly complete gaps 1 and 2?

	1	2
A	sharing	high
B	sharing	low
C	transfer	high
D	transfer	low

- 2 In which process is heat energy neither given out nor taken in?

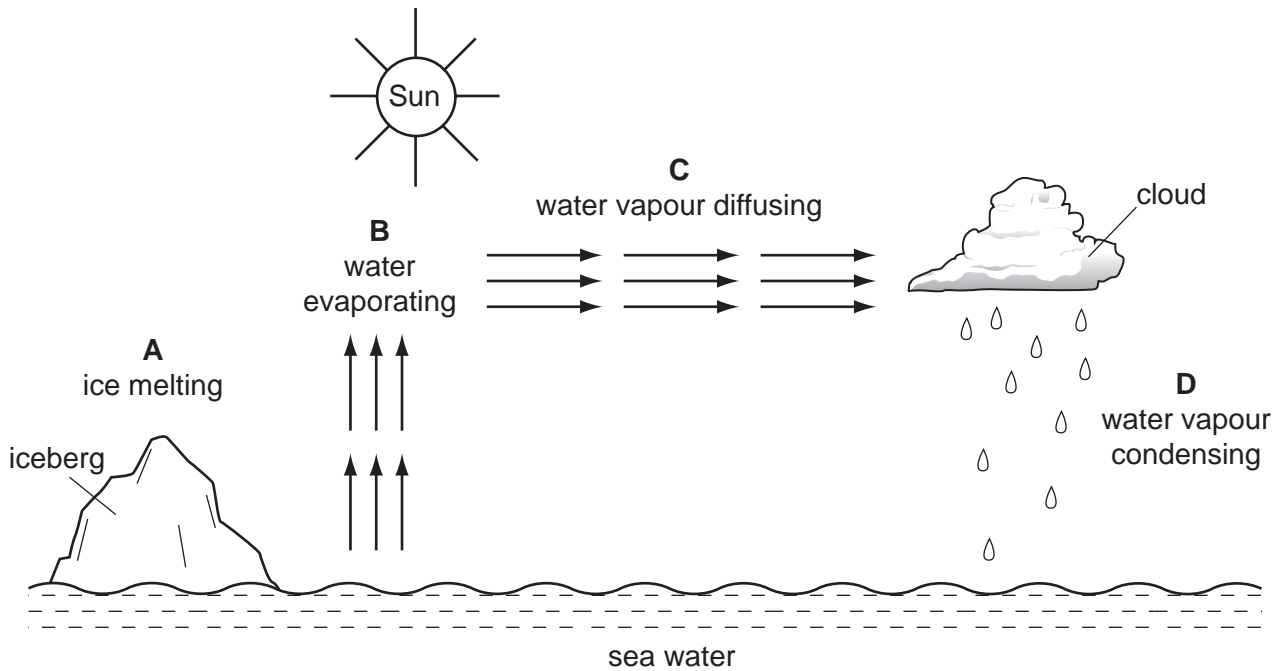

3 The diagram shows the structure of an atom.

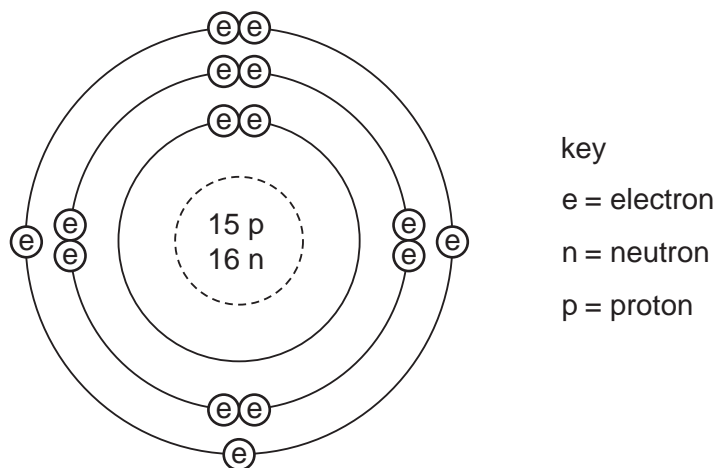

What are the nucleon number and proton number of the atom?

	nucleon number	proton number
A	15	30
B	16	31
C	31	15
D	31	16

4 A student reacts 10 cm^3 of hydrochloric acid with two large lumps of calcium carbonate. The calcium carbonate is in excess. He measures the rate of reaction by collecting the gas given off and measuring the volume every fifteen seconds.

The results are shown by curve X in the graph.

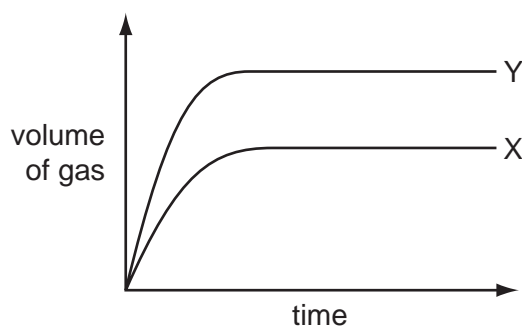

Which change to the experiment would give the curve Y?

- A** Heat the acid before adding it.
- B** Use 10 cm^3 of more concentrated acid.
- C** Use larger pieces of calcium carbonate.
- D** Use twice as much acid of the same concentration.

- 5 The diagram shows wood burning in air.



Which two words describe what happens to the wood and the type of reaction taking place?

	wood is	type of reaction
A	oxidised	endothermic
B	oxidised	exothermic
C	reduced	endothermic
D	reduced	exothermic

- 6 Ethyl ethanoate has the formula $\text{CH}_3\text{CO}_2\text{C}_2\text{H}_5$.

What is the relative molecular mass M_r of this compound?

- A** 48 **B** 72 **C** 88 **D** 124

- 7 Which can be used to show that a gas is ammonia?

A **B** **C** **D**

limewater splint flame moist litmus paper glowing splint

- 8 What must be formed when an acid reacts with a base?
- A carbon dioxide
 B hydrogen
 C oxygen
 D a salt
- 9 Which gas is produced when sodium carbonate reacts with hydrochloric acid?
- A carbon dioxide
 B chlorine
 C hydrogen
 D oxygen
- 10 The diagram shows an outline of part of the Periodic Table.

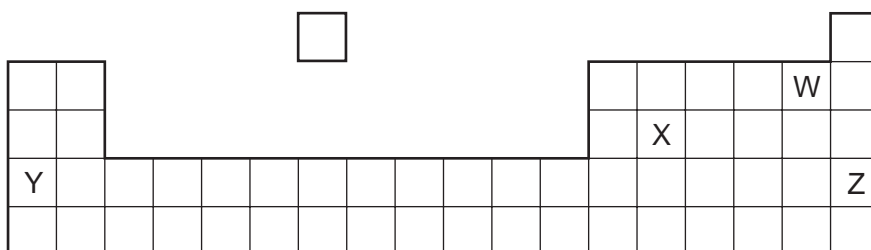

Which two elements could form a covalent compound?

- A W and X B W and Y C X and Y D X and Z
- 11 The element technetium, Tc (proton number 43), does not exist in nature.
- From its position in the Periodic Table, which description of technetium is most likely to be correct?
- A It is a brittle solid of low melting point.
 B It is a metal with a high melting point.
 C It is a soft, very reactive metal.
 D It is an unreactive gas.

- 12 The following statements are about rubidium, which is below potassium in Group I of the Periodic Table.

The melting point of rubidium is1..... than that of potassium.

The reaction of rubidium with water is2..... than that of potassium.

Which words correctly complete gaps 1 and 2?

	1	2
A	higher	faster
B	higher	slower
C	lower	faster
D	lower	slower

- 13 **A**, **B**, **C** and **D** are the properties of four metals produced from iron ore.

Which properties are most suitable for making cutlery?

- A** brittle and hard
- B** easily shaped and soft
- C** malleable and rusts
- D** resists corrosion and hard

- 14 Metal M is only present in its ores as a compound.

M is extracted from these compounds by heating them with carbon.

In which position in the reactivity series shown is M most likely to be found?

potassium

A

sodium

calcium

B

magnesium

zinc

C

iron

copper

D

15 Which statements about water are correct?

- 1 Water can be used as a solvent.
- 2 Water can be used to prevent iron from rusting.
- 3 Water is a compound that contains two parts of oxygen to one part of hydrogen.

A 1 only **B** 2 only **C** 1 and 3 **D** 2 and 3

16 Which gases are released into the air from burning coal?

	carbon monoxide	carbon dioxide	sulfur dioxide
A	✓	✓	✓
B	✓	✓	x
C	✓	x	✓
D	x	✓	x

17 Four different metals were placed in dilute hydrochloric acid.

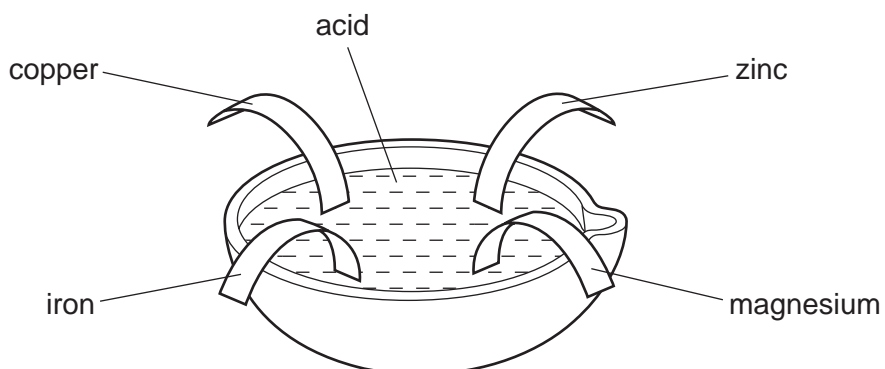

Which metal would **not** react?

- A** copper
- B** iron
- C** magnesium
- D** zinc

18 Which structure represents an unsaturated hydrocarbon?

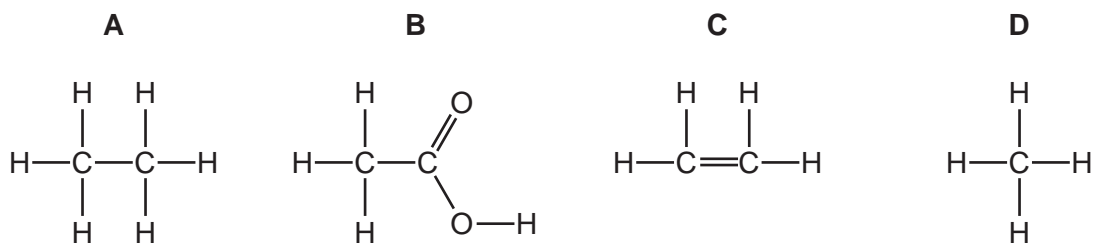

19 Propene, C_3H_6 , follows ethene in the alkene homologous series.

Which molecule could be made by the catalytic addition of steam to propene?

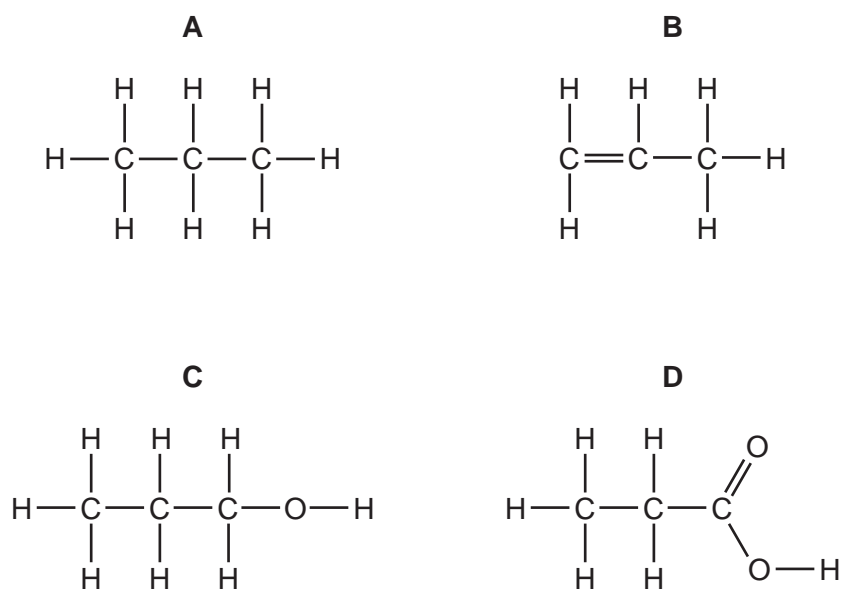

20 The diagram represents an apparatus used in the fractional distillation of crude oil.

From which position is methane obtained?

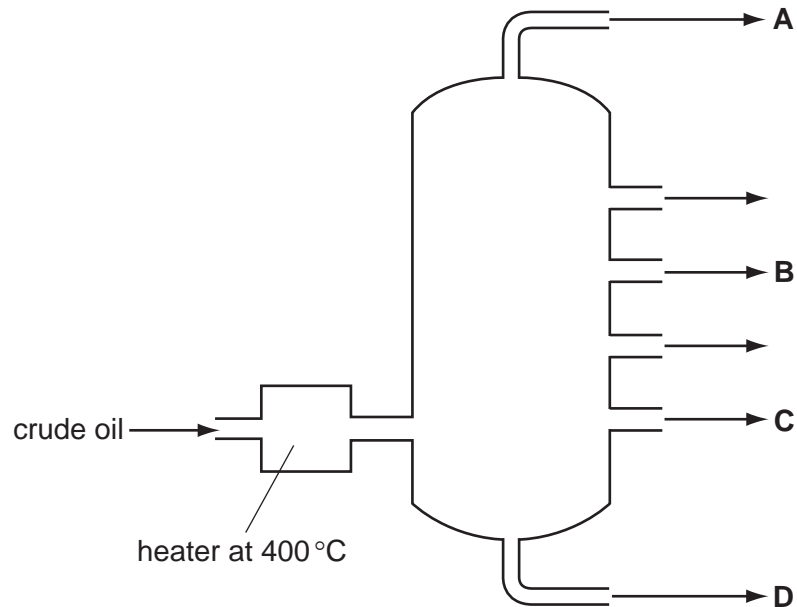

21 The diagram shows the change in speed of a car with time.

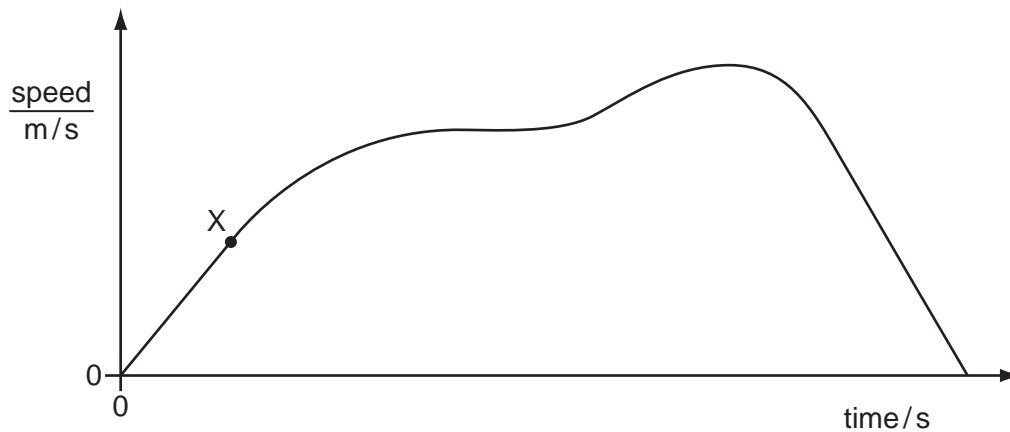

Which is the correct description of the motion of the car at point X?

- A It is moving at a constant speed.
- B It is moving at a decreasing speed.
- C It is moving at an increasing speed.
- D It is not moving.

- 22 A stopwatch is used to time a runner in a race. The diagrams show the stopwatch at the start and at the end of the last lap.



start of last lap



end of last lap

How long did the runner take to finish the last lap of the race?

- A 50.00 seconds
- B 50.10 seconds
- C 100.00 seconds
- D 100.10 seconds

23 A plane lamina with centre of mass X touches the ground at point P .

Which diagram shows the lamina in equilibrium?

A

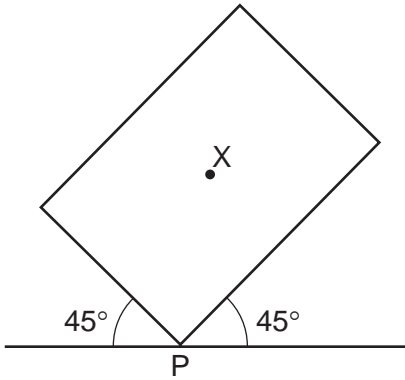

B

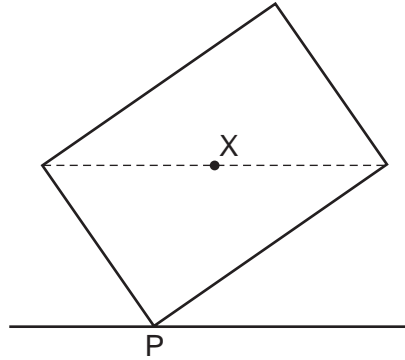

C

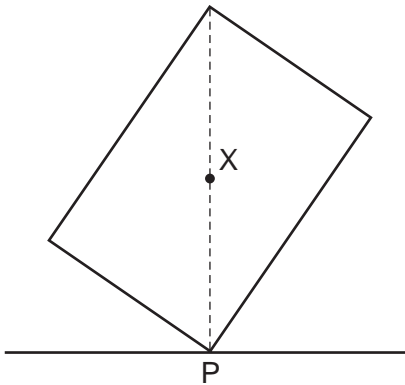

D

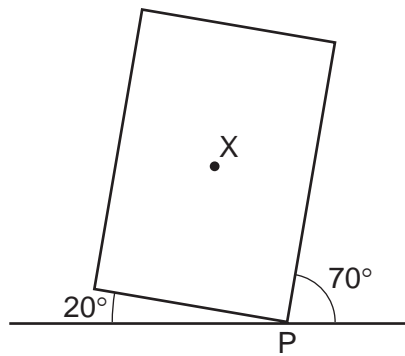

- 24 Two blocks X and Y are placed on a uniform beam. The beam balances on a pivot at its centre as shown.

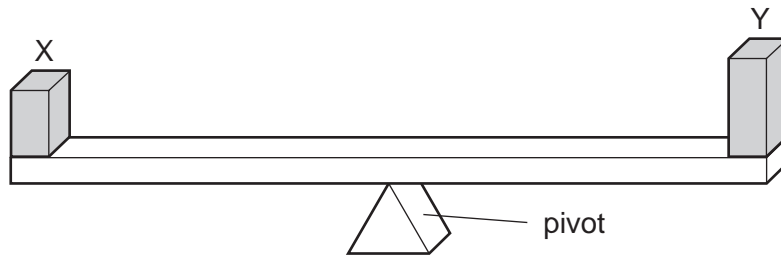

What does this show about X and Y?

- A They have the same mass and the same density.
 - B They have the same mass and the same weight.
 - C They have the same volume and the same density.
 - D They have the same volume and the same weight.
- 25 The diagram shows a convection current in water in a beaker.

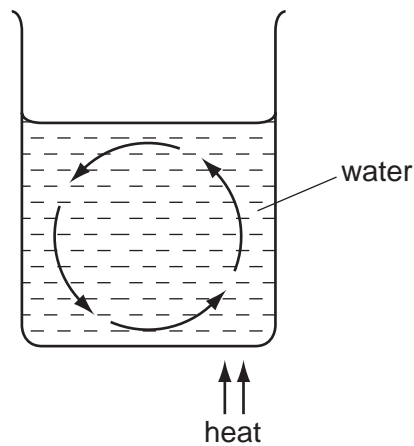

Which property of the water is changing and causing the convection current?

- A boiling point
- B density
- C mass
- D surface area

- 26 A coal-fired power station generates electricity. Coal is burnt and the energy released is used to boil water. The steam from the water makes the generator move and this produces electricity.

Which forms of energy are involved in this process?

- A chemical, heat, hydroelectric, electrical
 B chemical, heat, kinetic, electrical
 C geothermal, heat, kinetic, electrical
 D geothermal, kinetic, hydroelectric, electrical
- 27 Which physical property **cannot** be used for temperature measurement?
- A activity of a radioactive source
 B electrical resistance of a solid
 C pressure of a gas
 D volume of a liquid
- 28 The diagram shows the spectrum of electromagnetic waves.

Which labelled region represents radio waves?

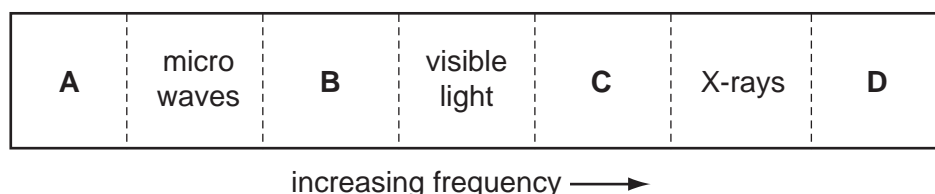

- 29 Waves hit the edge of a lake, one every 2.0 seconds. The distance between one wave crest and the next is 0.5 metres.

What are the frequency and the wavelength of the waves?

	frequency / Hz	wavelength / m
A	0.5	0.5
B	0.5	2.0
C	2.0	0.5
D	2.0	2.0

30 A light ray passes from air into glass.

Which labelled angle is the angle of refraction?

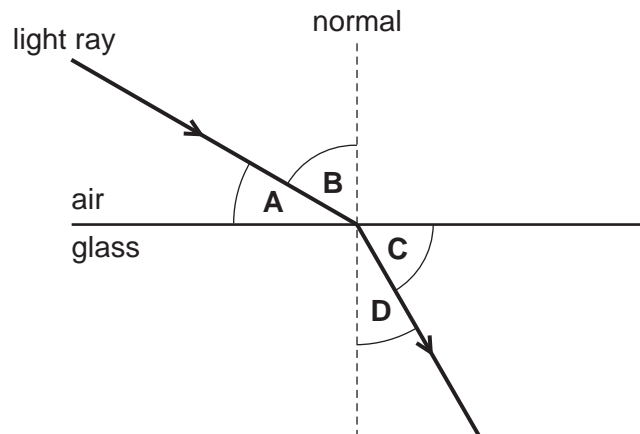

31 Two plastic rods, 1 and 2, are negatively charged. Rod 1 hangs freely.

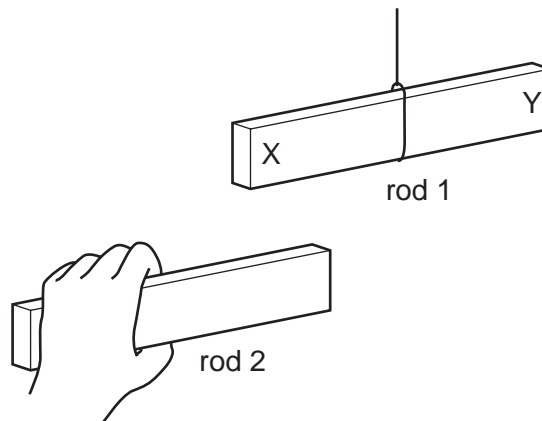

Rod 2 is brought near to end X of rod 1 and then near to end Y of rod 1.

What happens to the rods in each position?

	near end X	near end Y
A	they attract	they attract
B	they attract	they repel
C	they repel	they attract
D	they repel	they repel

32 The diagram shows an electric circuit with three meters, connected correctly.

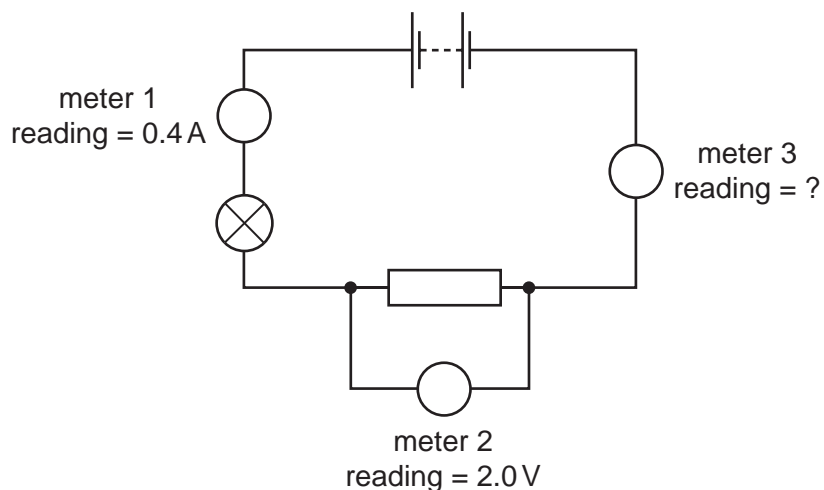

What is the reading on meter 3?

- A** 0.0A **B** 0.4A **C** 2.0V **D** 2.4V

33 An electromagnet with a soft iron core is connected to battery through an open switch. The soft iron core lies just above some small soft iron nails.

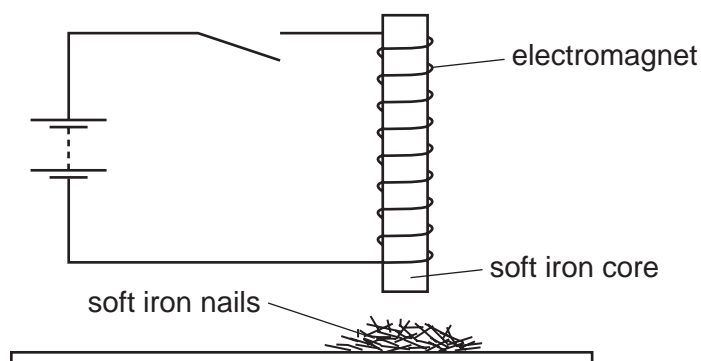

The switch is now closed, left closed for a few seconds, and then opened.

What do the soft iron nails do as the switch is closed and what do they do as the switch is then opened?

	as switch is closed	as switch is opened
A	nails jump up	nails fall down
B	nails jump up	nails stay up
C	nails stay down	nails jump up
D	nails stay down	nails stay down

34 The diagram shows different ways of arranging identical resistors.

Which arrangement has the smallest resistance?

A

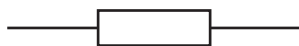

B



C

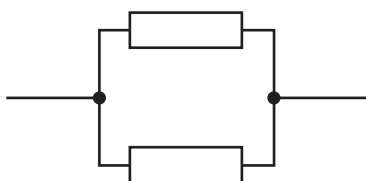

D

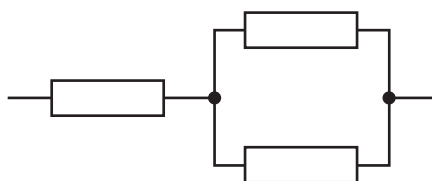

35 The current in an electric heater is 10 A. The heater is connected to the power supply using wire which is designed to carry a current of 5 A.

Why is this a hazard?

- A** The heater could explode.
- B** The wire could explode.
- C** The heater could become too hot and cause a fire.
- D** The wire could become too hot and cause a fire.

36 Which diagram is the V/I characteristic graph for a metallic conductor at constant temperature?

A

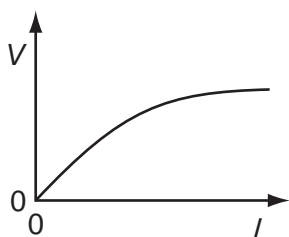

B

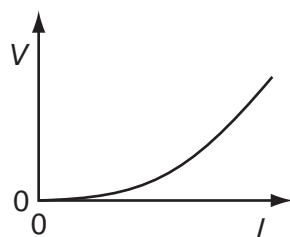

C

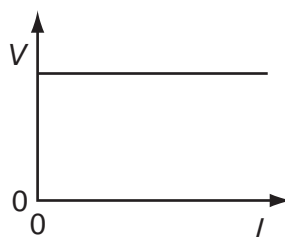

D

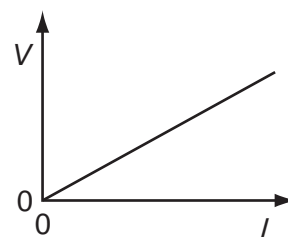

37 The diagram shows a cathode-ray oscilloscope.

Cathode rays are fast-moving electrons.

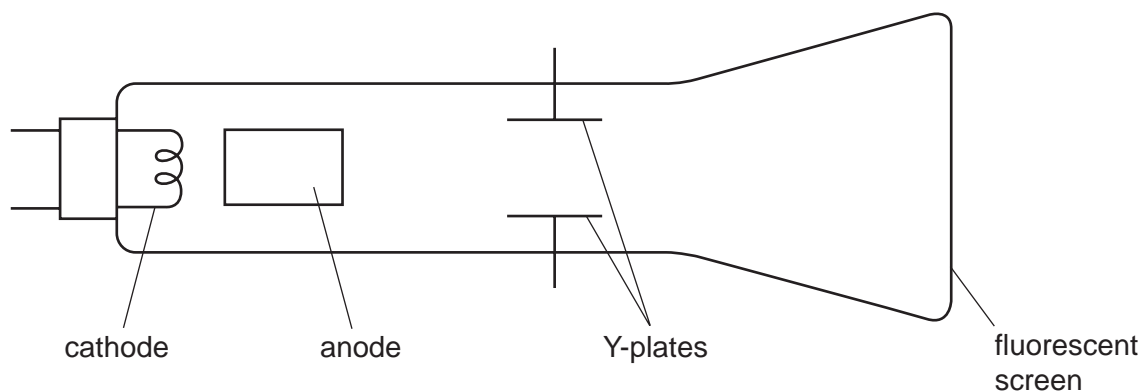

From where are the electrons released?

- A the anode
- B the cathode
- C the fluorescent screen
- D the Y-plates

38 A lithium nucleus contains 3 protons and 4 neutrons.

What is its nuclide notation?

- A ${}^3_4\text{Li}$ B ${}^4_3\text{Li}$ C ${}^7_3\text{Li}$ D ${}^7_4\text{Li}$

- 39 The diagram shows an experiment set up to study the penetrating properties of three types of radiation R, S and T from a radioactive source.

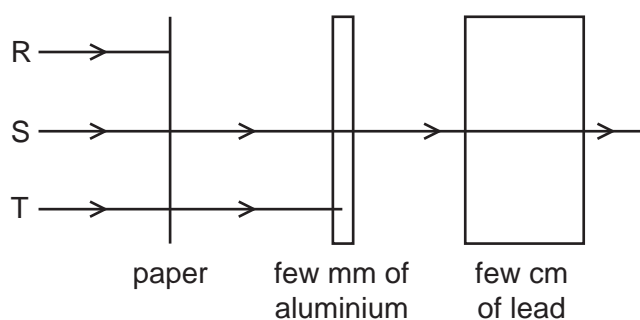

What types of radiation are R, S and T?

	R	S	T
A	alpha-particles	beta-particles	gamma-rays
B	alpha-particles	gamma-rays	beta-particles
C	beta-particles	alpha-particles	gamma-rays
D	gamma-rays	beta-particles	alpha-particles

- 40 The graph shows the radioactive decay curve of a substance.

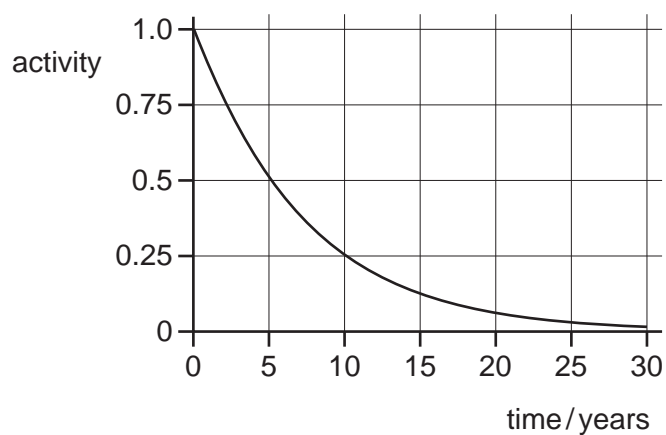

What is the half-life of this substance?

- A** 0.5 years **B** 5 years **C** 15 years **D** 30 years

DATA SHEET
The Periodic Table of the Elements

		Group										
		I	II	III	IV	V	VI	VII	VIII	IX	X	
		1 H Hydrogen 1										
		4 He Helium 2										
7	9	3	4	5	6	7	8	9	10	11	12	13
Li Lithium	Be Beryllium	B Boron	C Carbon	N Nitrogen	O Oxygen	F Fluorine	Ne Neon	Na Sodium	Mg Magnesium	Al Aluminium	Si Silicon	P Phosphorus
11	12	13	14	15	16	17	18	19	20	21	22	23
Na Sodium	Mg Magnesium	Al Aluminium	Si Silicon	P Phosphorus	S Sulfur	Cl Chlorine	Ar Argon	K Potassium	Ca Calcium	Sc Scandium	Ti Titanium	V Vanadium
19	20	21	22	23	24	25	26	27	28	29	30	31
K Potassium	Ca Calcium	Sc Scandium	Ti Titanium	V Vanadium	Cr Chromium	Mn Manganese	Fe Iron	Co Cobalt	Ni Nickel	Cu Copper	Zn Zinc	Ga Gallium
37	38	39	40	41	42	43	44	45	46	47	48	49
Rb Rubidium	Sr Strontium	Y Yttrium	Zr Zirconium	Nb Niobium	Mo Molybdenum	Tc Technetium	Ru Ruthenium	Rh Rhodium	Pd Palladium	Ag Silver	Cd Cadmium	In Indium
55	56	57	72	73	74	75	76	77	78	79	80	81
Cs Caesium	Ba Barium	La Lanthanum	Hf Hafnium	Ta Tantalum	W Tungsten	Re Rhenium	Os Osmium	Ir Iridium	Pt Platinum	Au Gold	Hg Mercury	Tl Thallium
87	88	89	†	†	†	†	†	†	†	†	†	†
Fr Francium	Ra Radium	Ac Actinium										
133	137	139	178	181	184	186	190	192	195	197	201	204
Cs Caesium	Ba Barium	La Lanthanum	Hf Hafnium	Ta Tantalum	W Tungsten	Re Rhenium	Os Osmium	Ir Iridium	Pt Platinum	Au Gold	Hg Mercury	Pb Lead
226	227	227	†	†	†	†	†	†	†	†	†	†
Fr Francium	Ra Radium	Ac Actinium										
169	173	175	175	175	175	175	175	175	175	175	175	175
Tm Thulium	Yb Ytterbium	Lu Lutetium	Lu Lutetium	Lu Lutetium	Lu Lutetium	Lu Lutetium	Lu Lutetium	Lu Lutetium	Lu Lutetium	Lu Lutetium	Lu Lutetium	Lu Lutetium
167	173	175	175	175	175	175	175	175	175	175	175	175
Er Erbium	Yb Ytterbium	Lu Lutetium	Lu Lutetium	Lu Lutetium	Lu Lutetium	Lu Lutetium	Lu Lutetium	Lu Lutetium	Lu Lutetium	Lu Lutetium	Lu Lutetium	Lu Lutetium
166	173	175	175	175	175	175	175	175	175	175	175	175
Fm Fermium	No Nobelium	Lu Lutetium	Lu Lutetium	Lu Lutetium	Lu Lutetium	Lu Lutetium	Lu Lutetium	Lu Lutetium	Lu Lutetium	Lu Lutetium	Lu Lutetium	Lu Lutetium
100	102	103	103	103	103	103	103	103	103	103	103	103
Fm Fermium	No Nobelium	Lu Lutetium	Lu Lutetium	Lu Lutetium	Lu Lutetium	Lu Lutetium	Lu Lutetium	Lu Lutetium	Lu Lutetium	Lu Lutetium	Lu Lutetium	Lu Lutetium

*58-71 Lanthanoid series
†90-103 Actinoid series

a = relative atomic mass

X = atomic symbol

b = proton (atomic) number

Key

a	X
b	

The volume of one mole of any gas is 24 dm³ at room temperature and pressure (r.t.p.).

Permission to reproduce items where third-party owned material protected by copyright is included has been sought and cleared where possible. Every reasonable effort has been made by the publisher (UCLES) to trace copyright holders, but if any items requiring clearance have unwittingly been included, the publisher will be pleased to make amends at the earliest possible opportunity.

University of Cambridge International Examinations is part of the Cambridge Assessment Group. Cambridge Assessment is the brand name of University of Cambridge Local Examinations Syndicate (UCLES), which is itself a department of the University of Cambridge.