



**Cambridge International Examinations**  
Cambridge International General Certificate of Secondary Education

CANDIDATE  
NAME

CENTRE  
NUMBER

--	--	--	--	--

CANDIDATE  
NUMBER

--	--	--	--

**MATHEMATICS**

**0581/41**

Paper 4 (Extended)

**October/November 2014**

**2 hours 30 minutes**

Candidates answer on the Question Paper.

Additional Materials:      Electronic calculator  
   Tracing paper (optional)

Geometrical instruments

**READ THESE INSTRUCTIONS FIRST**

Write your Centre number, candidate number and name on all the work you hand in.

Write in dark blue or black pen.

You may use an HB pencil for any diagrams or graphs.

Do not use staples, paper clips, glue or correction fluid.

**DO NOT WRITE IN ANY BARCODES.**

Answer **all** questions.

If working is needed for any question it must be shown below that question.

Electronic calculators should be used.

If the degree of accuracy is not specified in the question, and if the answer is not exact, give the answer to three significant figures. Give answers in degrees to one decimal place.

For  $\pi$ , use either your calculator value or 3.142.

At the end of the examination, fasten all your work securely together.

The number of marks is given in brackets [ ] at the end of each question or part question.

The total of the marks for this paper is 130.

This document consists of **19** printed pages and **1** blank page.



- 1 (a) A company makes compost by mixing loam, sand and coir in the following ratio.

$$\text{loam} : \text{sand} : \text{coir} = 7 : 2 : 3$$

- (i) How much loam is there in a 72 litre bag of the compost?

*Answer(a)(i)* ..... litres [2]

- (ii) In a small bag of the compost there are 13.5 litres of coir.

How much compost is in a small bag?

*Answer(a)(ii)* ..... litres [2]

- (iii) The price of a large bag of compost is \$8.40 .  
This is an increase of 12% on the price last year.

Calculate the price last year.

*Answer(a)(iii)* \$ ..... [3]

- (b) Teresa builds a raised garden bed in the shape of a hexagonal prism.

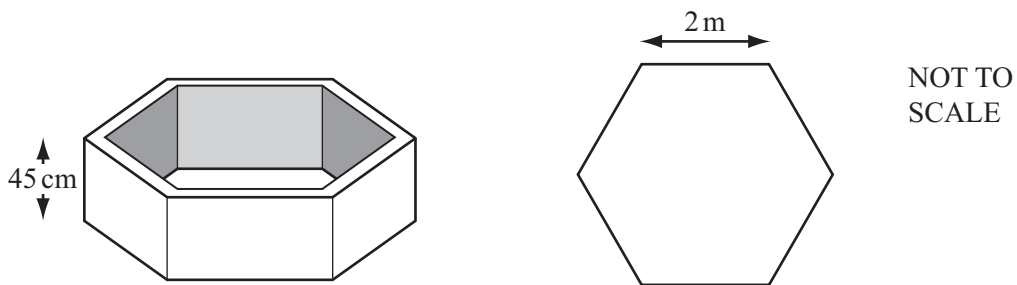

The garden bed has a height of 45 cm.

The cross section of the inside of the garden bed is a regular hexagon of side 2 m.

- (i) Show that the area of the cross section of the inside of the garden bed is  $10.4\text{m}^2$ , correct to 3 significant figures.

*Answer(b)(i)*

[3]

- (ii) Calculate the volume of soil needed to fill the garden bed.

*Answer(b)(ii)* .....  $\text{m}^3$  [2]

- (iii) Teresa wants to fill the garden bed with organic top soil.  
She sees this advertisement in the local garden centre.

ORGANIC TOP SOIL	Number of tonnes purchased		
	1 to 5	6 to 10	Over 10
<b>Cost per tonne</b>	\$47.00	\$45.50	\$44.00

Organic top soil is sold in one tonne bags.  
 $1\text{m}^3$  of organic top soil has a mass of 1250 kg.

Calculate the cost of the organic top soil needed to fill the garden bed completely.  
[1 tonne = 1000 kg]

*Answer(b)(iii)* \$ ..... [4]

- 2 (a) Rearrange the formula  $v^2 = u^2 - 2as$  to make  $u$  the subject.

*Answer(a)*  $u = \dots\dots\dots$  [2]

- (b) Chuck cycles along Skyline Drive.  
 He cycles 60 km at an average speed of  $x$  km/h.  
 He then cycles a further 45 km at an average speed of  $(x + 4)$  km/h.  
 His total journey time is 6 hours.

- (i) Write down an equation in  $x$  and show that it simplifies to  $2x^2 - 27x - 80 = 0$ .

*Answer(b)(i)*

[4]

- (ii) Solve  $2x^2 - 27x - 80 = 0$  to find the value of  $x$ .

*Answer(b)(ii)*  $x = \dots\dots\dots$  [3]

- (c) The diagram shows the speed-time graph for a car travelling along a road for  $T$  seconds.

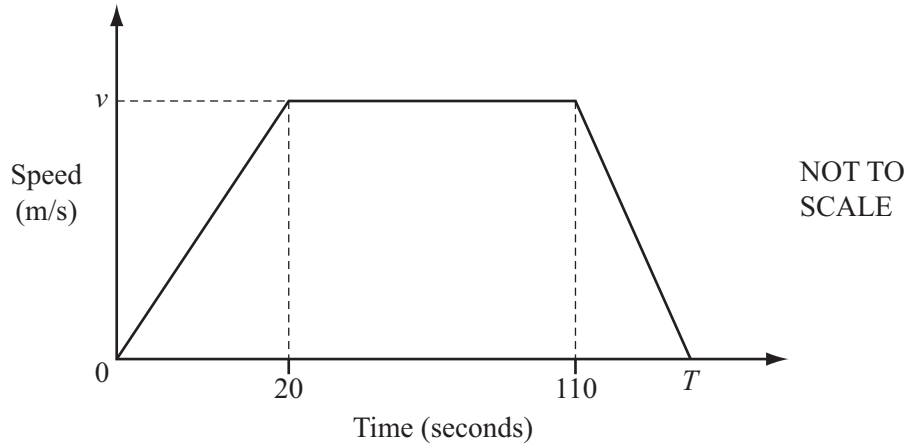

To begin with the car accelerated at  $0.75 \text{ m/s}^2$  for 20 seconds to reach a speed of  $v \text{ m/s}$ .

- (i) Show that the speed,  $v$ , of the car is  $15 \text{ m/s}$ .

*Answer(c)(i)*

[1]

- (ii) The total distance travelled is **1.8 kilometres**.

Calculate the total time,  $T$ , of the journey.

*Answer(c)(ii)* ..... seconds [4]

- (d) Asma runs 22 kilometres, correct to the nearest kilometre.  
She takes  $2\frac{1}{2}$  hours, correct to the nearest half hour.

Calculate the upper bound of Asma's speed.

*Answer(d)* ..... km/h [3]

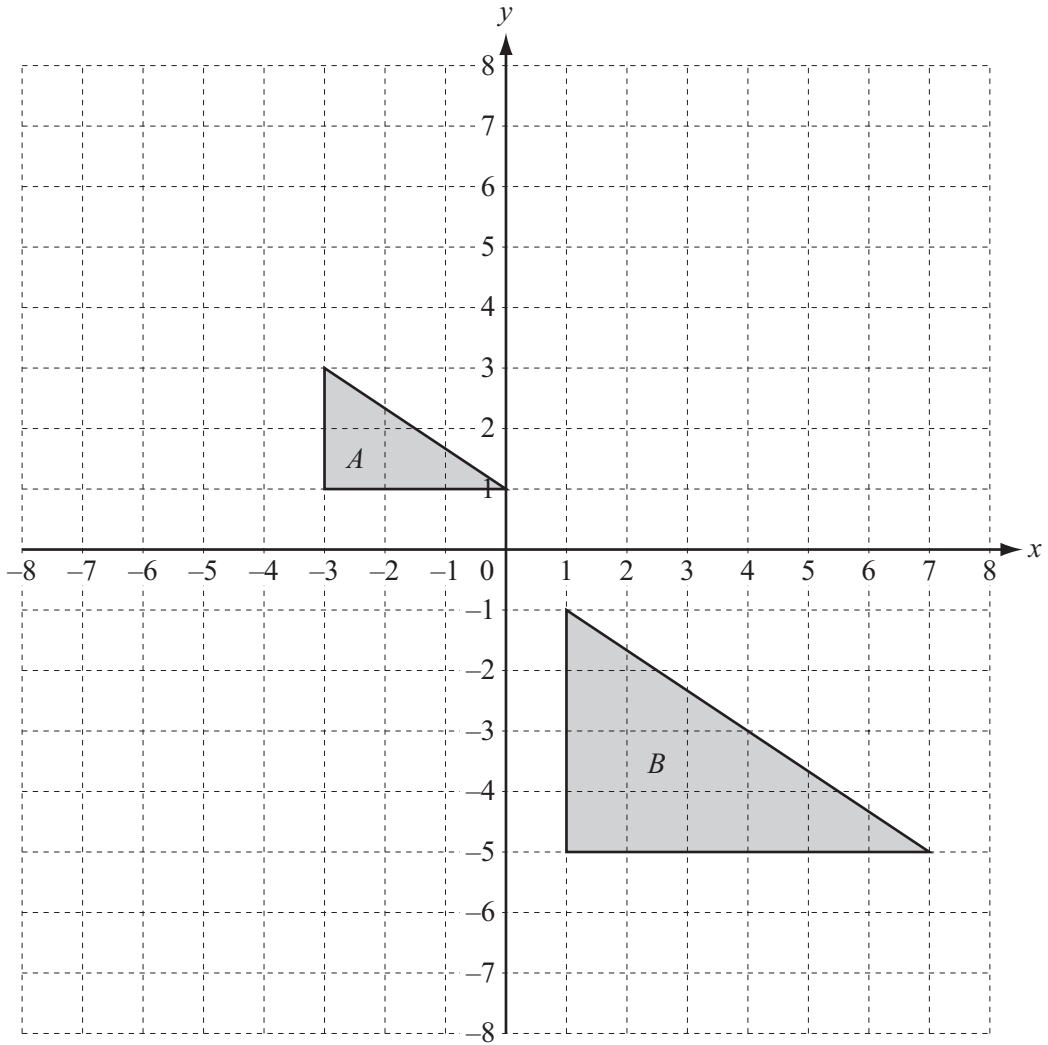

(a) Draw the image when triangle *A* is reflected in the line  $x = 0$ . [1]

(b) Draw the image when triangle *A* is rotated through  $90^\circ$  anticlockwise about  $(-4, 0)$ . [2]

(c) (i) Describe fully the **single** transformation that maps triangle *A* onto triangle *B*.

Answer(c)(i) ..... [3]

(ii) Complete the following statement.

Area of triangle *A* : Area of triangle *B* = ..... : ..... [2]

(d) Write down the matrix that represents a stretch, factor 4 with the  $y$ -axis invariant.

$$\text{Answer(d)} \quad \left( \begin{array}{cc} & \\ & \end{array} \right) \quad [2]$$

(e) (i) On the grid, draw the image of triangle  $A$  after the transformation represented by the matrix  $\begin{pmatrix} 1 & 0 \\ 2 & 1 \end{pmatrix}$ .

[3]

(ii) Describe fully this **single** transformation.

*Answer(e)(ii)* .....

..... [3]

(iii) Find the inverse of the matrix  $\begin{pmatrix} 1 & 0 \\ 2 & 1 \end{pmatrix}$ .

$$\text{Answer(e)(iii)} \quad \left( \begin{array}{cc} & \\ & \end{array} \right) \quad [2]$$

4 (a) Expand and simplify.

(i)  $4(2x - 1) - 3(3x - 5)$

*Answer(a)(i)* ..... [2]

(ii)  $(2x - 3y)(3x + 4y)$

*Answer(a)(ii)* ..... [3]

(b) Factorise.

$$x^3 - 5x$$

*Answer(b)* ..... [1]

(c) Solve the inequality.

$$\frac{2x + 1}{3} \leq \frac{5x - 8}{4}$$

*Answer(c)* ..... [3]



**(d) (i)**  $x^2 - 9x + 12 = (x - p)^2 - q$

Find the value of  $p$  and the value of  $q$ .

*Answer(d)(i)*  $p = \dots\dots\dots$

$q = \dots\dots\dots$  [3]

**(ii)** Write down the minimum value of  $x^2 - 9x + 12$ .

*Answer(d)(ii)*  $\dots\dots\dots$  [1]

**(iii)** Write down the equation of the line of symmetry of the graph of  $y = x^2 - 9x + 12$ .

*Answer(d)(iii)*  $\dots\dots\dots$  [1]

---

- 5 (a) Complete the table of values for  $y = x^2 + \frac{3}{x}$ ,  $x \neq 0$ .

$x$	-3	-2	-1	-0.5		0.4	0.6	1	1.5	2	3
$y$	8	2.5		-5.8		7.7	5.4	4	4.3		10

[2]

- (b) Draw the graph of  $y = x^2 + \frac{3}{x}$  for  $-3 \leq x \leq -0.5$  and  $0.4 \leq x \leq 3$ .

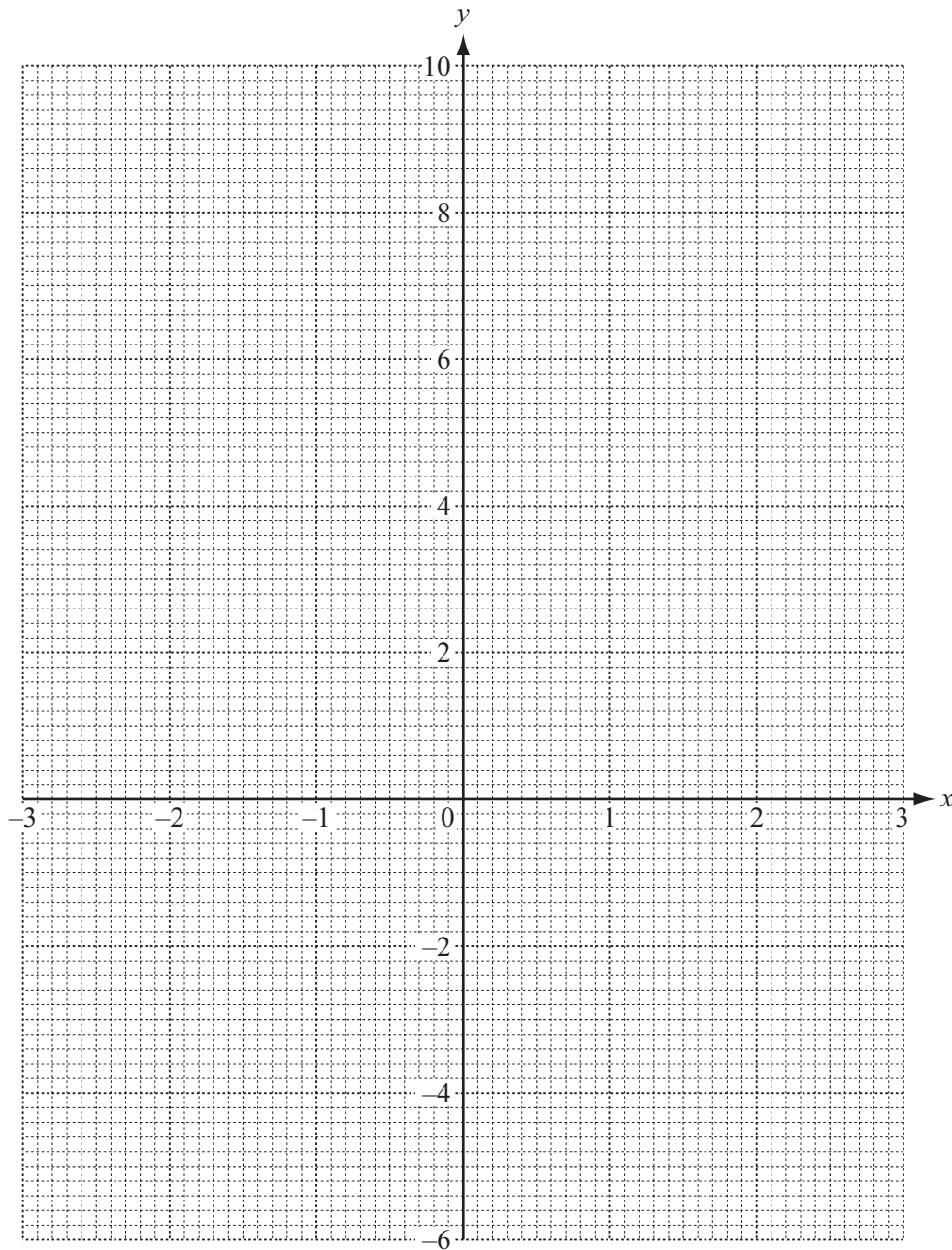

[5]

(c) Use your graph to solve the equation  $x^2 + \frac{3}{x} = 5$ .

*Answer(c)*  $x = \dots\dots\dots$  or  $x = \dots\dots\dots$  or  $x = \dots\dots\dots$  [3]

(d) By drawing a suitable straight line, solve the equation  $x^2 + \frac{3}{x} = x + 5$ .

*Answer(d)*  $x = \dots\dots\dots$  or  $x = \dots\dots\dots$  or  $x = \dots\dots\dots$  [4]

---

- 6 A company tested 200 light bulbs to find the lifetime,  $T$  hours, of each bulb. The results are shown in the table.

Lifetime ( $T$ hours)	Number of bulbs
$0 < T \leq 1000$	10
$1000 < T \leq 1500$	30
$1500 < T \leq 2000$	55
$2000 < T \leq 2500$	72
$2500 < T \leq 3500$	33

- (a) Calculate an estimate of the mean lifetime for the 200 light bulbs.

*Answer(a)* ..... hours [4]

- (b) (i) Complete the cumulative frequency table.

Lifetime ( $T$ hours)	$T \leq 1000$	$T \leq 1500$	$T \leq 2000$	$T \leq 2500$	$T \leq 3500$
Number of bulbs					

[2]

(ii) On the grid, draw a cumulative frequency diagram to show this information.

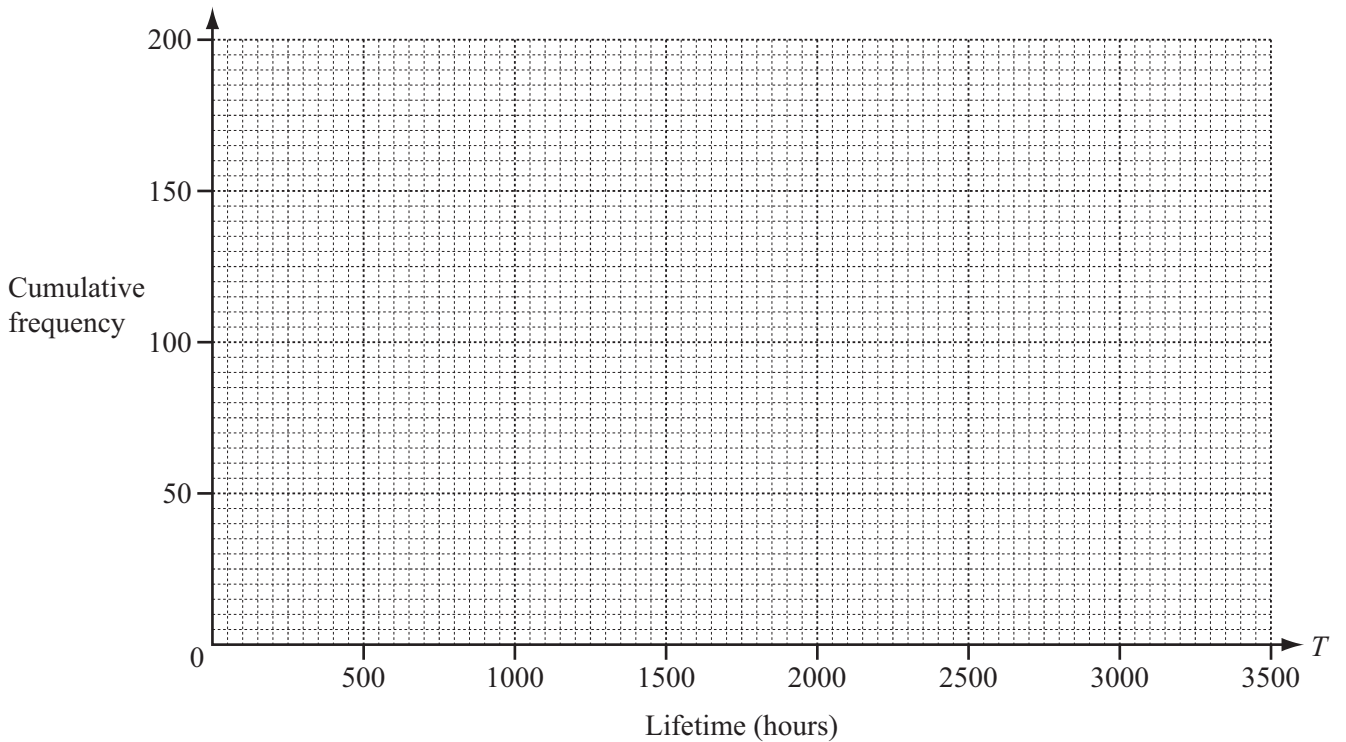

[3]

(iii) The company says that the average lifetime of a bulb is 2200 hours.

Estimate the number of bulbs that lasted longer than 2200 hours.

*Answer(b)(iii)* ..... [2]

(c) Robert buys one energy saving bulb and one halogen bulb.

The probability that the energy saving bulb lasts longer than 3500 hours is  $\frac{9}{10}$ .

The probability that the halogen bulb lasts longer than 3500 hours is  $\frac{3}{5}$ .

Work out the probability that exactly one of the bulbs will last longer than 3500 hours.

*Answer(c)* ..... [4]

- 7 (a) The diagram shows a circle with two chords,  $AB$  and  $CD$ , intersecting at  $X$ .

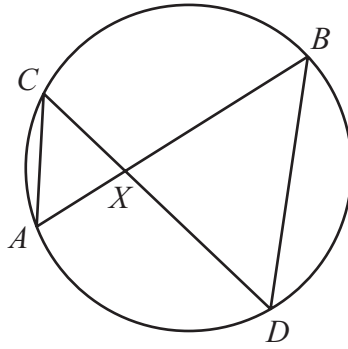

NOT TO  
SCALE

- (i) Show that triangles  $ACX$  and  $DBX$  are similar.

*Answer(a)(i)*

[2]

- (ii)  $AX = 3.2$  cm,  $BX = 12.5$  cm,  $CX = 4$  cm and angle  $AXC = 110^\circ$ .

- (a) Find  $DX$ .

*Answer(a)(ii)(a)*  $DX = \dots\dots\dots$  cm [2]

- (b) Use the cosine rule to find  $AC$ .

*Answer(a)(ii)(b)*  $AC = \dots\dots\dots$  cm [4]

(c) Find the area of triangle  $BXD$ .

Answer(a)(ii)(c) .....  $\text{cm}^2$  [2]

(b)

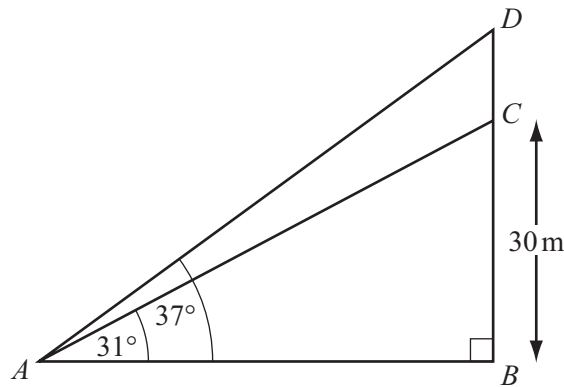

NOT TO  
SCALE

In the diagram,  $BC$  represents a building 30 m tall.  
A flagpole,  $DC$ , stands on top of the building.  
From a point,  $A$ , the angle of elevation of the top of the building is  $31^\circ$ .  
The angle of elevation of the top of the flagpole is  $37^\circ$ .

Calculate the height,  $DC$ , of the flagpole.

Answer(b) ..... m [5]

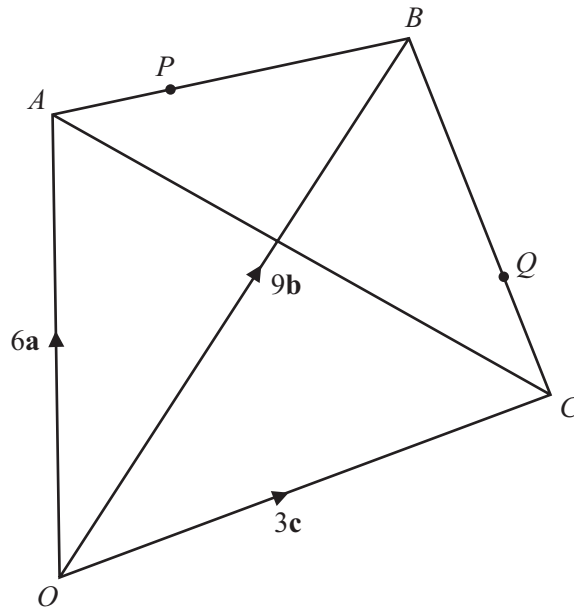

NOT TO  
SCALE

In the diagram,  $O$  is the origin and  $\vec{OA} = 6\mathbf{a}$ ,  $\vec{OB} = 9\mathbf{b}$  and  $\vec{OC} = 3\mathbf{c}$ .  
 The point  $P$  lies on  $AB$  such that  $\vec{AP} = 3\mathbf{b} - 2\mathbf{a}$ .  
 The point  $Q$  lies on  $BC$  such that  $\vec{BQ} = 2\mathbf{c} - 6\mathbf{b}$ .

- (a) Find, in terms of  $\mathbf{b}$  and  $\mathbf{c}$ , the position vector of  $Q$ .  
 Give your answer in its simplest form.

Answer(a) ..... [2]



(b) Find, in terms of **a** and **c**, in its simplest form

(i)  $\vec{AC}$ ,

*Answer(b)(i)*  $\vec{AC} = \dots\dots\dots$  [1]

(ii)  $\vec{PQ}$ .

*Answer(b)(ii)*  $\vec{PQ} = \dots\dots\dots$  [2]

(c) Explain what your answers in **part (b)** tell you about  $PQ$  and  $AC$ .

*Answer(c)* .....

..... [2]

---

9

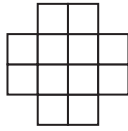

Diagram 1

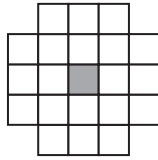

Diagram 2

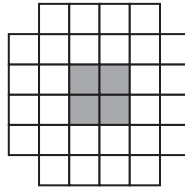

Diagram 3

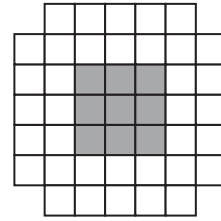

Diagram 4

The first four diagrams in a sequence are shown above.  
The diagrams are drawn using white squares and grey squares .

(a) Complete the columns in the table for Diagram 4 and Diagram  $n$ .

Diagram	1	2	3	4		$n$
Number of white squares	12	20	28			
Number of grey squares	0	1	4			
Total number of squares	12	21	32			$(n + 1)(n + 5)$

[6]

(b) Work out the number of the diagram which has a total of 480 squares.

Answer(b) ..... [2]

(c) The **total** number of squares in the **first  $n$  diagrams** is

$$\frac{1}{3}n^3 + pn^2 + qn.$$

(i) Use  $n = 1$  in this expression to show that  $p + q = 11\frac{2}{3}$ .

*Answer(c)(i)*

[1]

(ii) Use  $n = 2$  in the expression to show that  $4p + 2q = 30\frac{1}{3}$ .

*Answer(c)(ii)*

[2]

(iii) Find the values of  $p$  and  $q$ .

*Answer(c)(iii)*  $p = \dots\dots\dots$

$q = \dots\dots\dots$  [3]

**BLANK PAGE**

---

Permission to reproduce items where third-party owned material protected by copyright is included has been sought and cleared where possible. Every reasonable effort has been made by the publisher (UCLES) to trace copyright holders, but if any items requiring clearance have unwittingly been included the publisher will be pleased to make amends at the earliest possible opportunity.

Cambridge International Examinations is part of the Cambridge Assessment Group. Cambridge Assessment is the brand name of University of Cambridge Local Examinations Syndicate (UCLES), which is itself a department of the University of Cambridge.