



DESIGN AND TECHNOLOGY

0445/21

Paper 2 Graphic Products

October/November 2018

MARK SCHEME

Maximum Mark: 50

Published

This mark scheme is published as an aid to teachers and candidates, to indicate the requirements of the examination. It shows the basis on which Examiners were instructed to award marks. It does not indicate the details of the discussions that took place at an Examiners' meeting before marking began, which would have considered the acceptability of alternative answers.

Mark schemes should be read in conjunction with the question paper and the Principal Examiner Report for Teachers.

Cambridge International will not enter into discussions about these mark schemes.

Cambridge International is publishing the mark schemes for the October/November 2018 series for most Cambridge IGCSE™, Cambridge International A and AS Level components and some Cambridge O Level components.

This document consists of **5** printed pages.

Generic Marking Principles

These general marking principles must be applied by all examiners when marking candidate answers. They should be applied alongside the specific content of the mark scheme or generic level descriptors for a question. Each question paper and mark scheme will also comply with these marking principles.

GENERIC MARKING PRINCIPLE 1:

Marks must be awarded in line with:

- the specific content of the mark scheme or the generic level descriptors for the question
- the specific skills defined in the mark scheme or in the generic level descriptors for the question
- the standard of response required by a candidate as exemplified by the standardisation scripts.

GENERIC MARKING PRINCIPLE 2:

Marks awarded are always **whole marks** (not half marks, or other fractions).

GENERIC MARKING PRINCIPLE 3:

Marks must be awarded **positively**:

- marks are awarded for correct/valid answers, as defined in the mark scheme. However, credit is given for valid answers which go beyond the scope of the syllabus and mark scheme, referring to your Team Leader as appropriate
- marks are awarded when candidates clearly demonstrate what they know and can do
- marks are not deducted for errors
- marks are not deducted for omissions
- answers should only be judged on the quality of spelling, punctuation and grammar when these features are specifically assessed by the question as indicated by the mark scheme. The meaning, however, should be unambiguous.

GENERIC MARKING PRINCIPLE 4:

Rules must be applied consistently e.g. in situations where candidates have not followed instructions or in the application of generic level descriptors.

GENERIC MARKING PRINCIPLE 5:

Marks should be awarded using the full range of marks defined in the mark scheme for the question (however; the use of the full mark range may be limited according to the quality of the candidate responses seen).

GENERIC MARKING PRINCIPLE 6:

Marks awarded are based solely on the requirements as defined in the mark scheme. Marks should not be awarded with grade thresholds or grade descriptors in mind.

Section A

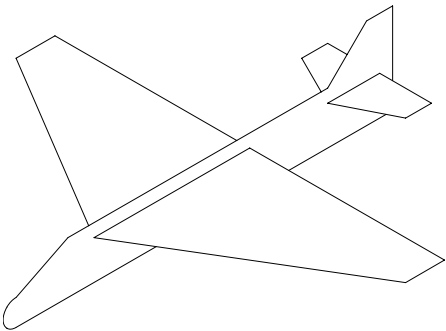
Question	Answer	Marks
A1(a)	 <p>Base line of fuselage (bottom of nose to bottom of tail) 150 mm (1) Vertical back edge of tail 35 mm (1) Top edge of tail 10 mm (1) Sloping front edge of tail (1) Back long edge of main wing 150 mm (1) correct position 75 mm each side (1) Two short edges of main wing 15 mm (1) Two angled front edges of main wing (1) Back long edge of back wing 40 mm (1) correct position 20 mm each side (1) Two short edges of back wing 10 mm (1) Two angled front edges of back wing (1)</p>	12

Question	Answer	Marks
A2(a)	Two letters added to correct size and in proportion (2)	2
A2(b)	Right angled triangle 30 mm × 16 mm in correct position (1)	1

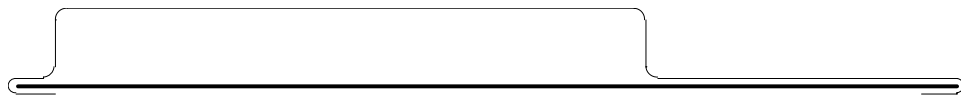
Question	Answer	Marks
A3(a)	 <p>Blister 20 mm deep (1) Blister 150 mm wide (1) In correct position (1) Bottom edge curled over card same as top edge (1) Radiused corners inner (1) Draft angle shown on blister (1)</p>	6
A3(b)	Any from the following: Polystyrene, HIPS	1
A3(c)	Lower Bed (1) Heat Plastic – Decision loop to above Heat Plastic with YES / NO (1) Wait for plastic to cool / Unclamp when cool (1)	3

Section B

Question	Answer	Marks
B4(a)	Plan view: Outline 90mm wide (1) × 60 mm high (1) Two vertical dividers 30 mm apart (1) + (1) Horizontal divider in centre (1) Front view: Outline of bottom holder 90 mm (1) × 40 mm (1) Top line of handle correct height 40 mm (1) 55 mm long (1) correct position (1) Two sloping side lines from top corners (1) + (1) Two semi circles in correct positions (1) + (1) Two lines joining top and bottom of semi-circles to form handle hole (1)	15
B4(b)	Major axis 60 mm (1) Minor axis 40 mm (1) Some construction (1) or clear construction (2) Six or less points plotted (1) or seven or more points plotted (2) Ellipse profile correct to overlay (1)	7
B4(c)(i)	Computer Aided Design (1) must have all 3 words	1
B4(c)(ii)	Advantage: Higher Quality Image, Higher resolution, better quality, clearer image, more colours available (1) Disadvantage: Larger file size, takes up more disk space, longer to download/upload, pixelates/goes blurry/blocky when enlarged (1)	2

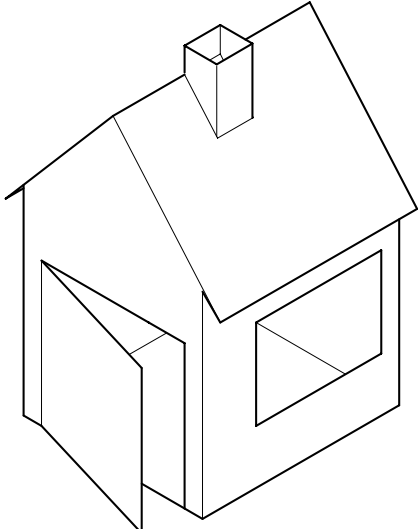
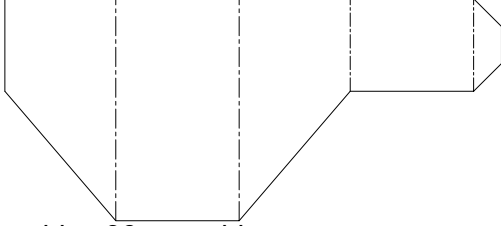
Question	Answer	Marks
B5(a)	 <p data-bbox="316 786 762 1155"> Left and right side bottom edges (1) Left and right side vertical edge (1) Right and left roof slope and ridge (1) Right bottom roof edge (1) Roof overhang front right (1) Window outline (1) Top and right side of doorway (1) 3 sides of door (1) 2 top front edges of chimney (1) 2 top back edges of chimney (1) Left and right sides of chimney (1) </p>	11
B5(b)	 <p data-bbox="316 1429 810 1626"> Two sides 36 mm wide (1) Height of both sides 30 mm (1) Two sloping lines to complete 2 sides (1) Small side 40 mm wide (1) Flap/tab added to one end (1) Dotted/dashed fold lines (1) </p>	6
B5(c)	<p data-bbox="316 1659 991 1924"> Line from front bottom corner to VP (1) Line from Front top corner to VP (1) Line from roof ridge to VP (1) Three lines from 3 corners of chimney to VP (1) Two lines from top and bottom of side window to VP (1) Vertical back edge of house (1) Vertical back edge of window (1) Vertical and horizontal edges of chimney (1) </p>	8