



UNIVERSITY OF CAMBRIDGE INTERNATIONAL EXAMINATIONS
International General Certificate of Secondary Education

DESIGN AND TECHNOLOGY

0445/12

Paper 1 Design

May/June 2011

1 hour 15 minutes

Candidates answer on the pre-printed A3 Answer Sheets.

Additional Materials: Standard drawing equipment

To be taken together with the optional paper for which you have been entered in one session of 2 hours and 15 minutes.

READ THESE INSTRUCTIONS FIRST

Write your Centre number, candidate number and name in the spaces on **both** printed Answer Sheets.
Write in dark blue or black pen.

You may use a soft pencil for any diagrams, graphs or rough working.
Do not use staples, paper clips, highlighters, glue or correction fluid.

Answer **one** question.

Write/draw your answers in the spaces provided on the Answer Sheets.
You may use a calculator.

At the end of the examination, fasten all your work securely together.
The number of marks is given in brackets [] at the end of each question or part question.

This document consists of 4 printed A4 pages and an Insert.



Answer **one** question only on the A3 pre-printed answer sheets provided.

- 1 Changing a baby's nappy (diaper) can be difficult especially if the baby is on the floor and the items required are not close at hand.



Design a baby changing unit that could be used in the home.

- (a) List **four** additional points about the function of such a unit that you consider to be important. [4]
- (b) Use sketches and notes to show **two** types of storage system that might form part of such a unit. [4]
- (c) Develop and sketch **three** ideas for the unit. [12]
- (d) Evaluate your ideas and justify why you have chosen **one** idea to develop more fully. [8]
- (e) Draw, using a method of your own choice, a full solution to the problem. Include construction details and major dimensions. [12]
- (f) Suggest suitable specific materials for your solution and give reasons for your choice. [4]
- (g) Outline a method used to manufacture **one** part of your solution in the school workshop. [6]

- 2 A school stationery shop has decided to sell sets of the items shown below, under the name NEW TERM.

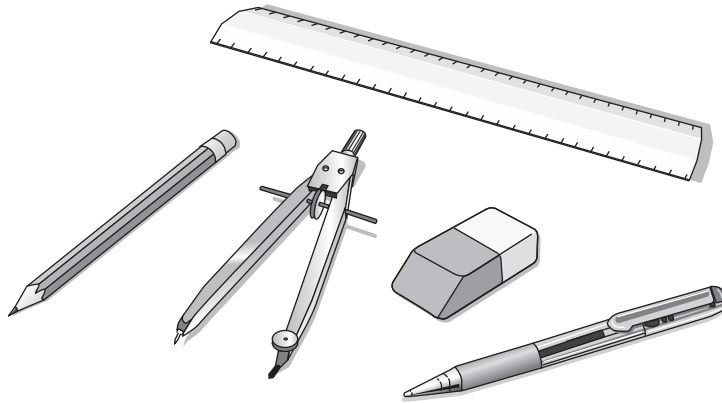

Design a package for the items so that the contents can be seen when on sale in the shop. It should be possible to remove and replace items regularly without damage to the package.

- (a) List **four** additional points about the function of such a package that you consider to be important. [4]
- (b) Use sketches and notes to show **two** methods by which items can be made visible in packages. [4]
- (c) Develop and sketch **three** ideas for the package. [12]
- (d) Evaluate your ideas and justify why you have chosen **one** idea to develop more fully. [8]
- (e) Draw, using a method of your own choice, a full solution to the problem. Include construction details and major dimensions. [12]
- (f) Suggest suitable specific materials for your solution and give reasons for your choice. [4]
- (g) Outline a method of producing a prototype of your solution in the school graphics studio. [6]

3 Cats and other small pets need to be fed regularly.



Design an automatic feeding system that would provide a small pet with the correct amount of food twice a day for a period of three days.

- (a) List **four** additional points about the function of such a feeding system that you consider to be important. [4]
- (b) Use sketches and notes to show **two** safe power sources for such a feeding system. [4]
- (c) Develop and sketch **three** ideas for the feeding system. [12]
- (d) Evaluate your ideas and justify why you have chosen **one** idea to develop more fully. [8]
- (e) Draw, using a method of your own choice, a full solution to the problem. Include construction details and major dimensions. [12]
- (f) Suggest suitable materials for your solution and give reasons for your choice. [4]
- (g) Outline a method used to manufacture **one** part of your solution in the school workshop. [6]

Permission to reproduce items where third-party owned material protected by copyright is included has been sought and cleared where possible. Every reasonable effort has been made by the publisher (UCLES) to trace copyright holders, but if any items requiring clearance have unwittingly been included, the publisher will be pleased to make amends at the earliest possible opportunity.

University of Cambridge International Examinations is part of the Cambridge Assessment Group. Cambridge Assessment is the brand name of University of Cambridge Local Examinations Syndicate (UCLES), which is itself a department of the University of Cambridge.