



UNIVERSITY OF CAMBRIDGE INTERNATIONAL EXAMINATIONS
International General Certificate of Secondary Education

CANDIDATE
NAME

CENTRE
NUMBER

--	--	--	--	--

CANDIDATE
NUMBER

--	--	--	--

* 7 5 4 8 9 6 8 2 4 9 *

CO-ORDINATED SCIENCES

0654/62

Paper 6 Alternative to Practical

May/June 2011

1 hour

Candidates answer on the Question paper

No Additional Materials are required.

READ THESE INSTRUCTIONS FIRST

Write your Centre number, candidate number and name on all the work you hand in.

Write in dark blue or black pen.

You may use a soft pencil for any diagrams, graphs, tables or rough working.

Do not use staples, paper clips, highlighters, glue or correction fluid.

DO NOT WRITE IN ANY BARCODES.

Answer **all** questions.

At the end of the examination, fasten all your work securely together.

The number of marks is given in brackets [] at the end of each question or part question.

For Examiner's Use	
1	
2	
3	
4	
5	
6	
Total	

This document consists of **18** printed pages and **2** blank pages.



1 (a) (i) A student performed an experiment to investigate the energy content of bread.

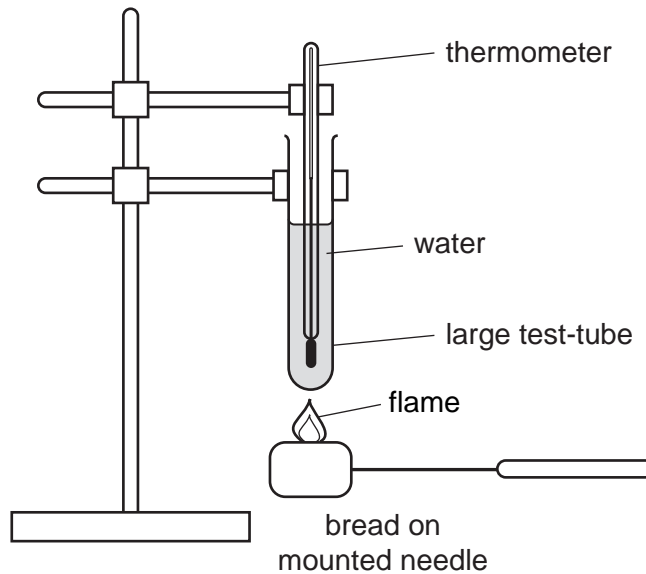

Fig. 1.1

- He placed 20cm^3 of water into a large test-tube and clamped it with a stand as shown in Fig. 1.1.
- He clamped a thermometer into the water.
- He measured the starting temperature of the water, t_s .
- He measured the mass of the bread, m_b , and recorded it in Table 1.1.
- Using a mounted needle, he picked up the bread and ignited it using a Bunsen burner.
- He quickly placed the burning bread under the large test-tube and heated the water.
- He measured the maximum temperature, t_m , that the water reached.

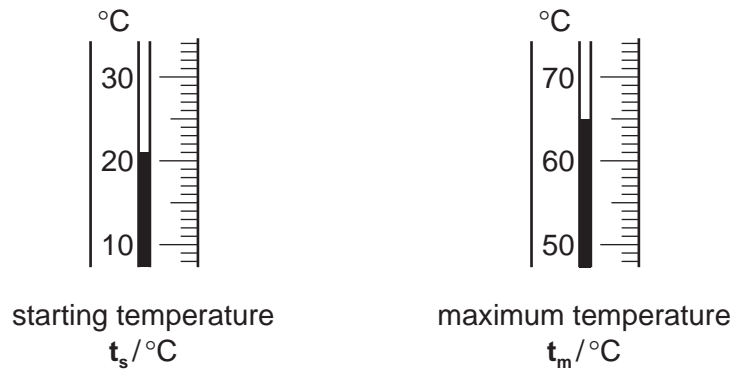

Fig. 1.2

- (i) Using Fig. 1.2, record t_s , the starting temperature, and t_m , the maximum temperature in Table 1.1. [2]

Table 1.1

starting temperature $t_s / ^\circ\text{C}$	maximum temperature $t_m / ^\circ\text{C}$	temperature rise $T = (t_m - t_s) / ^\circ\text{C}$	mass of bread m_b / g	mass of water m_w / g
			12.6	20

- (ii) Calculate T , the temperature rise of the water, using $T = t_m - t_s$.

Record it in Table 1.1.

[1]

- (iii) The energy content of the bread can be determined by using the formula

$$E = \frac{m_w \times T \times 4.2}{m_b \times 1000} \text{ kJ/g}$$

Calculate the energy content of the bread.

Show your working.

energy content of bread = kJ/g [2]

For
Examiner's
Use

(b) (i) The true energy content of bread is much higher than the value that you have calculated. By reference to the experiment, suggest reasons for the difference.

.....
.....
.....
..... [2]

(ii) Suggest **one** way in which the accuracy of the experiment could be improved.

.....
..... [1]

(c) Suggest how the results will change if the experiment is repeated with bread covered with an equal mass of butter. Explain your answer.

.....
.....
.....
..... [2]

Please turn over for Question 2.

- 2 (a) A student is investigating three liquid fuels, **A**, **B** and **C** to find which one gives the largest temperature rise.

For
Examiner's
Use

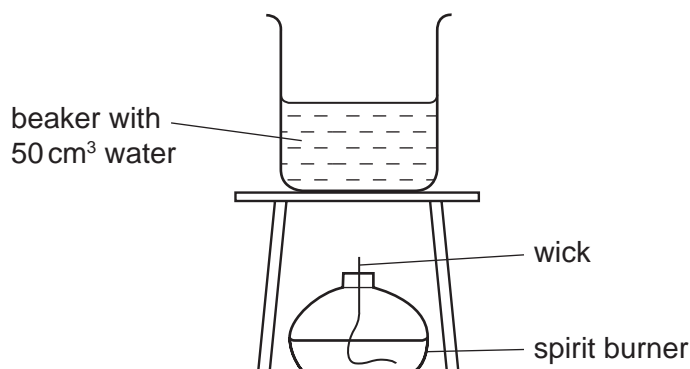
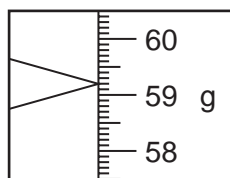

Fig. 2.1

- She fills a spirit burner with fuel **A**. Its mass is measured and recorded in Table 2.1.
- She places 50 cm³ of water in the beaker on the tripod above the spirit burner, as in Fig. 2.1. She measures the temperature of the water and records it in Table 2.2.
- She lights the wick and allows it to burn for 5 minutes, then extinguishes the flame.
- She measures the temperature of the water after heating and records it in Table 2.2.
- She measures the mass of the spirit burner again and records this in Table 2.1.
- Then she repeats all the steps using fuel **B** and then fuel **C**.

Table 2.1

	fuel A	fuel B	fuel C
mass of burner and fuel before burning/g	57.0		
mass of burner and fuel after burning/g	55.5	57.9	58.2
mass of fuel used/g	1.5		



fuel B

Fig. 2.2

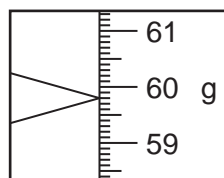

fuel C

Fig. 2.3

- (i) Use Fig. 2.2 to find, and record in Table 2.1, the mass of the spirit burner and fuel **B**. [1]

- (ii) Use Fig. 2.3 to find, and record in Table 2.1, the mass of the spirit burner and fuel **C**. [1]
- (iii) Calculate the mass of fuel used in each experiment and record it in Table 2.1. [1]

For
Examiner's
Use

Table 2.2

	fuel A	fuel B	fuel C
temperature of water before heating / °C	15.5	15.5	15.5
temperature of water after heating / °C	56.8		
temperature rise / °C	41.3		

- (iv) The thermometers in Fig. 2.4 show the temperatures of the 50 cm³ of water after being heated for 5 minutes. Read the thermometers for each fuel and record the temperatures in Table 2.2. [2]

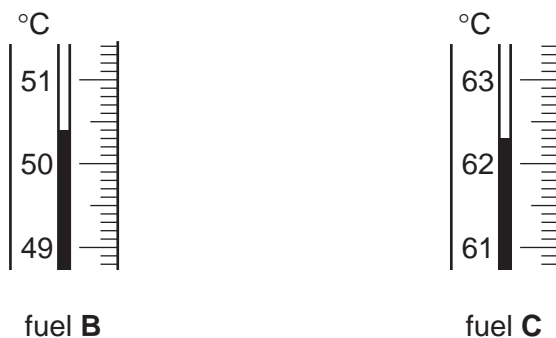

Fig. 2.4

- (v) Use the data in Table 2.2 to calculate the temperature rise caused by fuels **B** and **C**.

Record these values in Table 2.2. [1]

- (b) Not all the heat produced by the fuel is used to heat the water.

Suggest **one** improvement to the experiment so that more heat is used in heating the water.

.....
..... [1]

(c) The temperature rise per gram, **T**, for fuel **A** is 27.5 °C/g.

Calculate the temperature rise per gram for fuels **B** and **C**.

Use the formula

$$T = \frac{\text{temperature rise}}{\text{mass of fuel}}$$

T for fuel **B** = °C/g

T for fuel **C** = °C/g [2]

(d) The liquid with the highest value of **T** may not be suitable for use as a fuel in the home.

Suggest a property that could make this liquid unsuitable to use as a fuel.

.....
..... [1]

For
Examiner's
Use

- 3 (a) A student is finding the mass of a metre rule using the principle of moments.

He sets up the apparatus as in Fig. 3.1.

A pin to act as a pivot is pushed through the 100 mm mark of a metre rule into a cork clamped to the stand.

The rule is kept horizontal by a newton meter at the 900 mm mark.

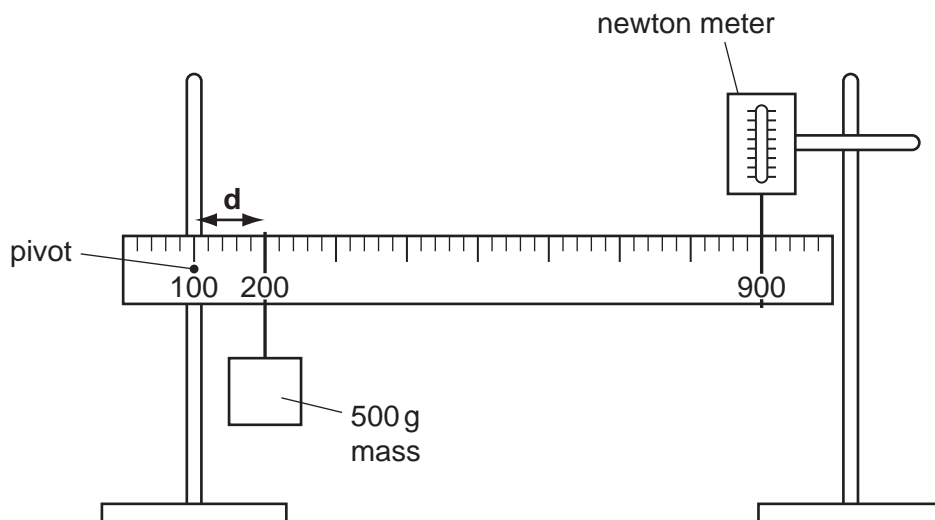

Fig. 3.1

A 500 g mass is hung at the 200 mm mark, 100 mm from the pivot, this is distance d .

The force on the newton meter required to keep the rule horizontal is measured and recorded in Table 3.1.

- (i) Read the newton meters in Fig. 3.2, for, $d = 200$ mm and $d = 300$ mm and record the values in Table 3.1. [2]

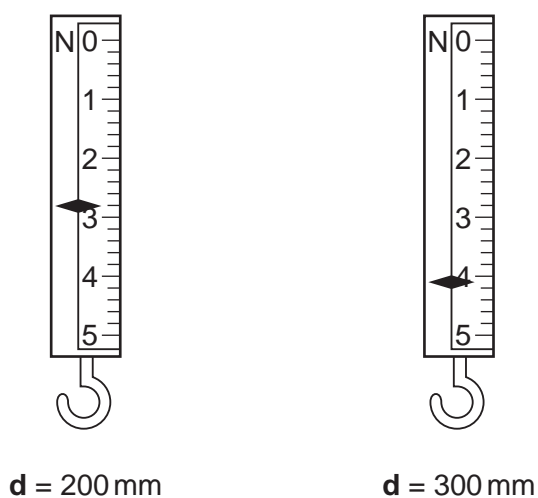

Fig. 3.2

Table 3.1

d/mm	force/N
100	1.8
150	2.3
200	
250	3.5
300	
350	4.6
400	5.2

For
Examiner's
Use

(ii) On the grid below, plot a graph of force (vertical axis) against distance.

Draw the best straight line, it will not pass through the point (0,0).

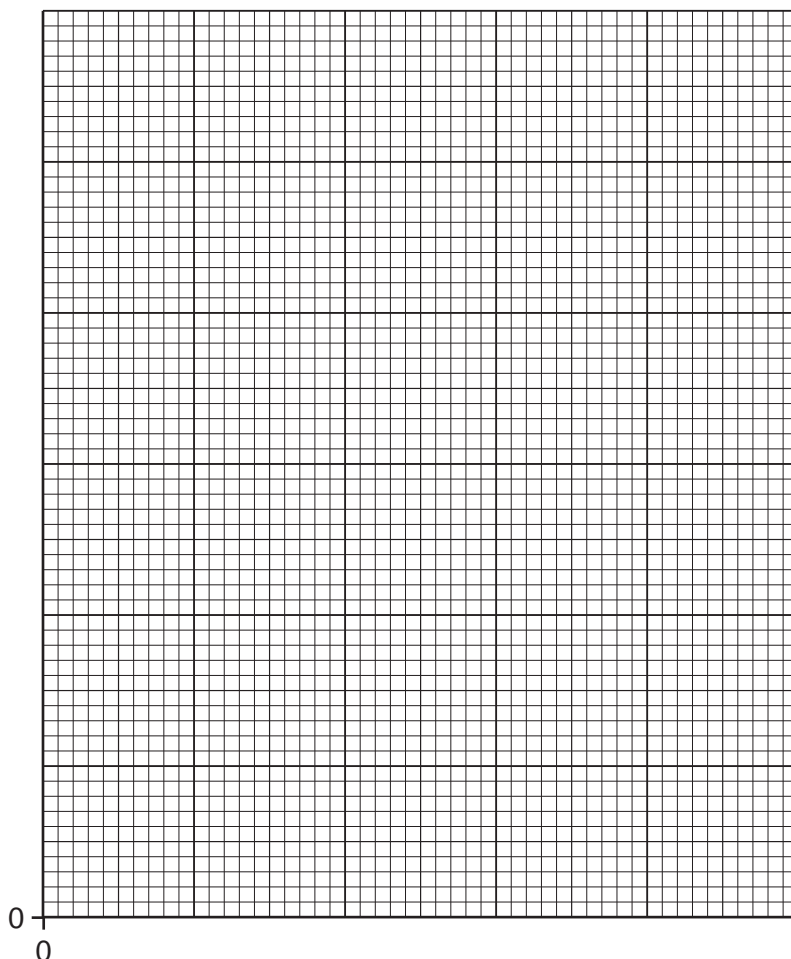

[4]

(iii) Extend the line you have drawn until it cuts the vertical axis.

Read off the value of the force when the distance $d = 0$.

force = N [1]

(b) (i) Convert the force from (a)(iii) into a mass in grams. Remember that the force of gravity on 100g is 1 N.

mass = g [1]

(ii) The mass of the metre rule is twice the value found in (b)(i).

Calculate the mass of the rule.

mass of rule = g [1]

(c) The accuracy could be improved by making sure the rule is exactly horizontal when taking the measurements.

Suggest how the student can make sure the rule is horizontal.

.....
.....
..... [1]

- 4 A student was studying fruits. The photographs in Fig. 4.1 show each whole fruit and a section through the fruit to show the internal structures.

For
Examiner's
Use







name of fruit	whole fruit	section through fruit
melon		
fig		
kiwifruit		
mango		

Fig. 4.1

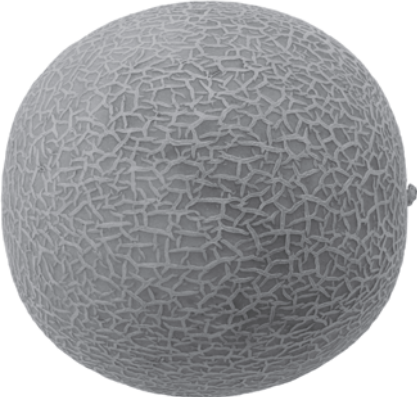
- (a) Measure the maximum distance, **d**, as in Fig. 4.2 of each **whole fruit** in the photographs. Include all parts of the fruit including petioles (stalks) and enter the distance **d** in Table 4.1.

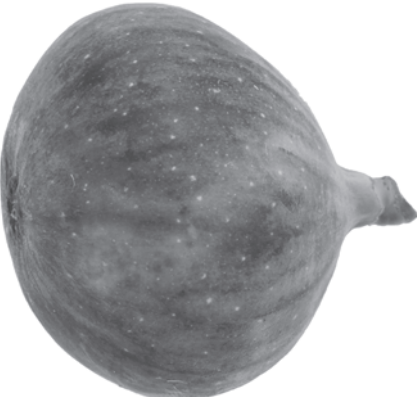
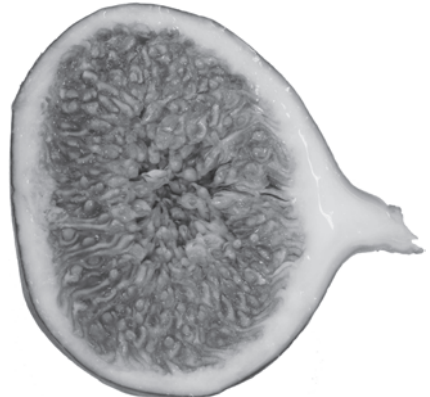
For
Examiner's
Use

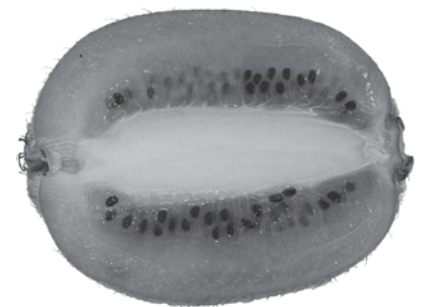
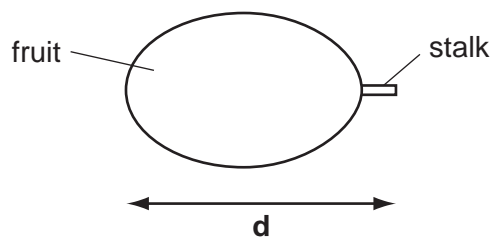

Fig. 4.2

Table 4.1

fruit	actual size of fruit/mm	distance d/mm	fraction of actual size
melon	120		
fig	58		
kiwifruit	77		
mango	125		

[2]

- (b) The photographs show the fruits to be of similar sizes. However the actual sizes of the fruits varied considerably.

Use your measurements for **d** to find how much each photograph was scaled down.

Use the following equation for each fruit and enter the values in Table 4.1.

$$\text{fraction of actual size} = \frac{\text{distance } d}{\text{actual size of fruit}}$$

[4]

(c) The student created a key for these fruits. A key is used to identify living organisms.

An example of a key to identify different arthropods is shown.

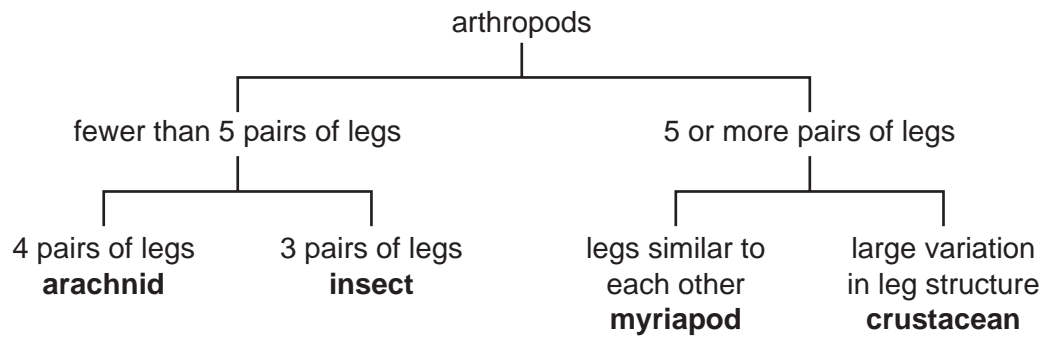

Using information from Fig. 4.1 and Table 4.1 construct a key for the fruits. Use the given example of a key to help you. Check that the key would enable all of the fruits to be identified.

For
Examiner's
Use

[4]

- 5 (a) A student is trying to confirm Hooke's Law which states

"The extension of a spring is directly proportional to the force extending it."

The apparatus is set up as shown in Fig. 5.1.

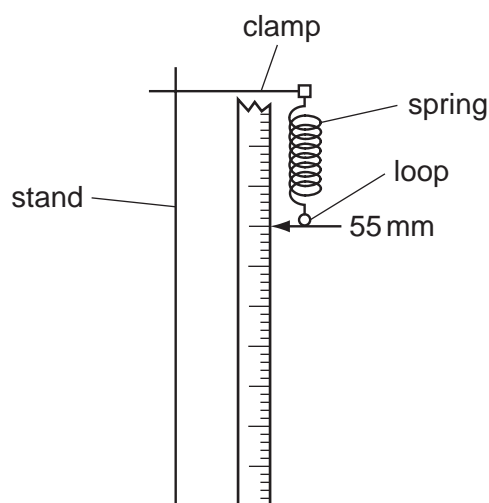

Fig. 5.1

He records in Table 5.1 the position of the pointer on the rule.

He now hangs a holder, weight 1 N, to the loop and reads the new position of the pointer. He calculates the extension. These measurements are placed in Table 5.1.

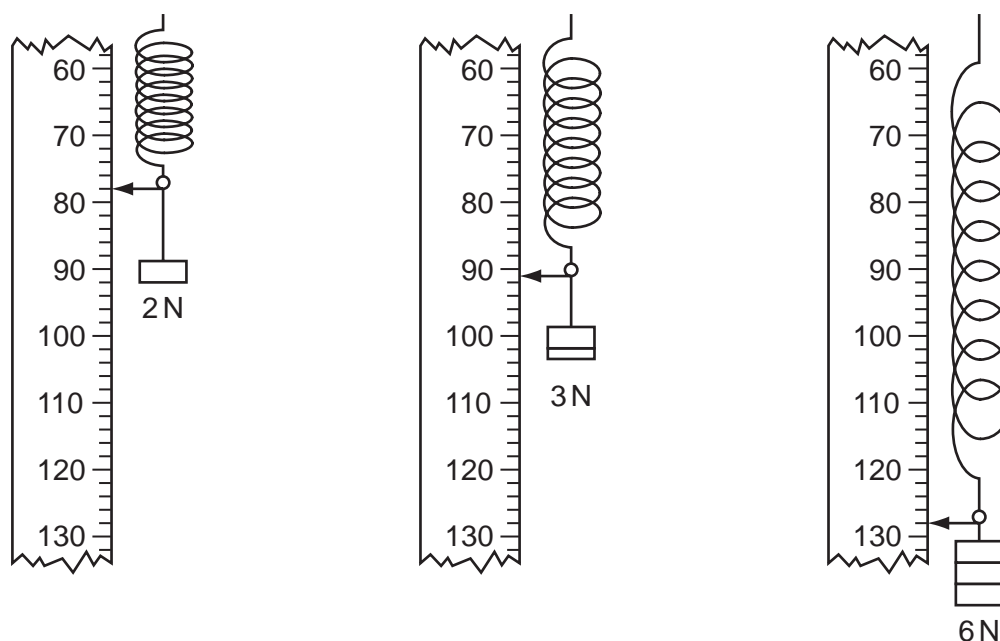

Fig. 5.2

- (i) Fig. 5.2 shows the springs with 2 N, 3 N and 6 N weights attached. Read off the position of the pointer each time, and record the values in Table 5.1. [3]

Table 5.1

weights/N	position of pointer, d/mm	total extension/mm
0	55	0
1	67	12
2		
3		
5	115	60
6		
9	165	110
10	235	180

For
Examiner's
Use

- (ii) Calculate the missing extensions for weights 2 N, 3 N and 6 N and complete Table 5.1. [1]

- (b) (i) Plot a graph of total extension against weight. Draw the best line.

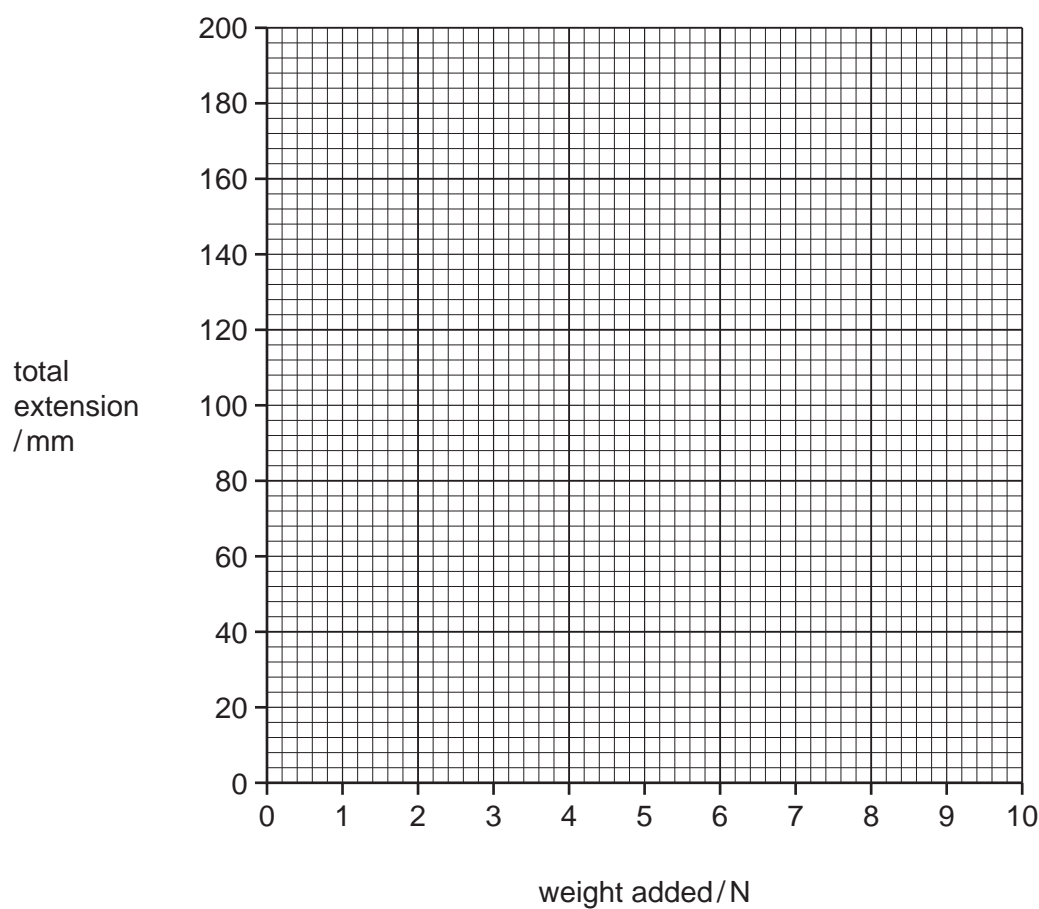

[2]

Fig. 5.3

(ii) Does the graph confirm Hooke's Law?

Explain your answer.

.....
.....
.....
..... [3]

(c) The student removes all the weights from the spring and observes that the pointer does not return to the 55 mm mark. Give a reason for this.

.....
.....
..... [1]

- 6 (a) Solid **X** is a mixture of two compounds, each containing different ions.

A student places solid **X** into a large test-tube, adds about 10 cm³ water, stoppers the tube and shakes it for a minute.

She filters the mixture, and saves the filtrate for part (b).

- (i) She scrapes the residue into a test-tube and adds 2 cm³ of hydrochloric acid. Bubbles of carbon dioxide gas are given off.

Describe the test for carbon dioxide.

test

.....

result

..... [2]

- (ii) Give the name of the anion that gives off carbon dioxide when hydrochloric acid is added.

..... [1]

- (iii) To the mixture from (a)(i) she adds aqueous sodium hydroxide, drop by drop, until no further reaction occurs.

She sees a white precipitate which dissolves to form a colourless solution.

Name the cation in the mixture.

..... [1]

For
Examiner's
Use

(b) The filtrate from part (a) is a blue colour. She divides the filtrate into three test-tubes.

- To the first test-tube she adds aqueous sodium hydroxide, drop by drop until it is in excess.
- To the second test-tube she adds aqueous ammonia, again drop by drop until it is in excess.
- She determines that copper ions are present.

Describe the observations she sees.

observations with aqueous sodium hydroxide

.....
.....
.....

observations with aqueous ammonia

.....
.....
..... [4]

(c) (i) To the third test-tube of the filtrate, she adds a few drops of dilute hydrochloric acid followed by aqueous barium chloride.

A white precipitate is formed.

What anion causes this?

..... [1]

(ii) Why does hydrochloric acid need to be added in the test in (c)(i)?

..... [1]

BLANK PAGE

Permission to reproduce items where third-party owned material protected by copyright is included has been sought and cleared where possible. Every reasonable effort has been made by the publisher (UCLES) to trace copyright holders, but if any items requiring clearance have unwittingly been included, the publisher will be pleased to make amends at the earliest possible opportunity.

University of Cambridge International Examinations is part of the Cambridge Assessment Group. Cambridge Assessment is the brand name of University of Cambridge Local Examinations Syndicate (UCLES), which is itself a department of the University of Cambridge.