

Centre Number	Candidate Number	Name
---------------	------------------	------

CAMBRIDGE INTERNATIONAL EXAMINATIONS
International General Certificate of Secondary Education

CO-ORDINATED SCIENCES

0654/01

Paper 1 Multiple Choice

October/November 2003

45 minutes

Additional Materials: Multiple Choice Answer Sheet
Soft clean eraser
Soft pencil (type B or HB is recommended)

READ THESE INSTRUCTIONS FIRST

Write in soft pencil.

Do not use staples, paper clips, highlighters, glue or correction fluid.

Write your name, Centre number and candidate number on the answer sheet in the spaces provided unless this has been done for you.

There are **forty** questions on this paper. Answer **all** questions. For each question there are four possible answers **A, B, C, and D**.

Choose the **one** you consider correct and record your choice in **soft pencil** on the separate answer sheet.

Read the instructions on the Answer Sheet very carefully.

Each correct answer will score one mark. A mark will not be deducted for a wrong answer.

Any rough working should be done in this booklet.

A copy of the Periodic Table is printed on page 20.

This document consists of **18** printed pages and **2** blank pages.

1 The table shows some features of four vertebrates.

feature	vertebrate			
	P	Q	R	S
has hair	✓	X	✓	X
has feathers	X	✓	X	X
has scales	X	X	X	✓
has wings	✓	✓	X	X
lays eggs	X	✓	X	✓
produces milk	✓	X	✓	X

Which two vertebrates belong to the same class?

- A** P and Q **B** P and R **C** Q and S **D** R and S

2 The diagram shows a plant cell.

In which part of the cell is starch produced?

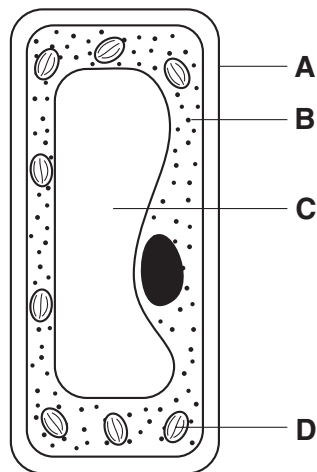

3 The diagram shows a synovial joint.

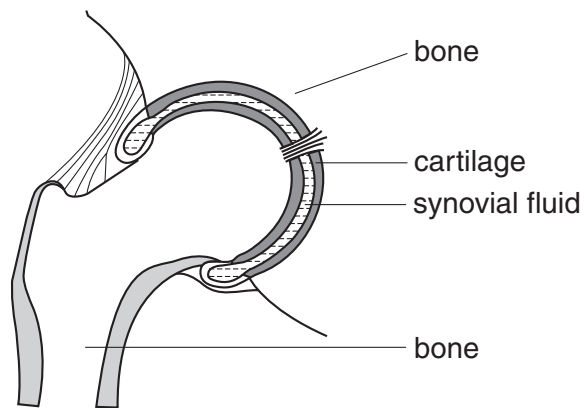

Which parts of this joint help to reduce friction?

	bone	cartilage	synovial fluid
A	✓	✓	✗
B	✗	✓	✓
C	✗	✗	✓
D	✓	✗	✗

- 4 An experiment is set up as shown to investigate starch production in the leaves of a plant. After six hours in sunlight, leaf **Y** is tested for starch.

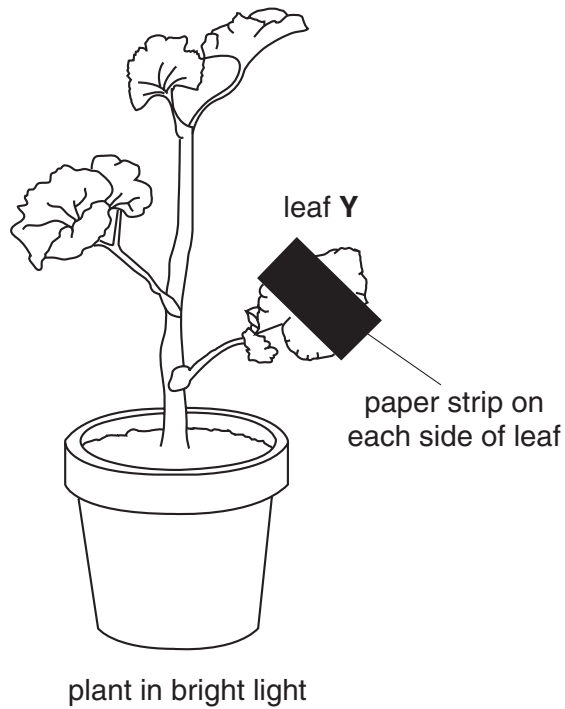

There is no starch produced under the paper strip because there was an absence of

- A carbon dioxide.
 - B chlorophyll.
 - C light.
 - D oxygen.
- 5 Which sequence shows the correct order of structures through which air passes when we breathe in?
- A alveolus → bronchiole → bronchus → trachea
 - B bronchus → trachea → alveolus → bronchiole
 - C bronchiole → alveolus → bronchus → trachea
 - D trachea → bronchus → bronchiole → alveolus

6 The diagram shows the blood circulatory system of a human.

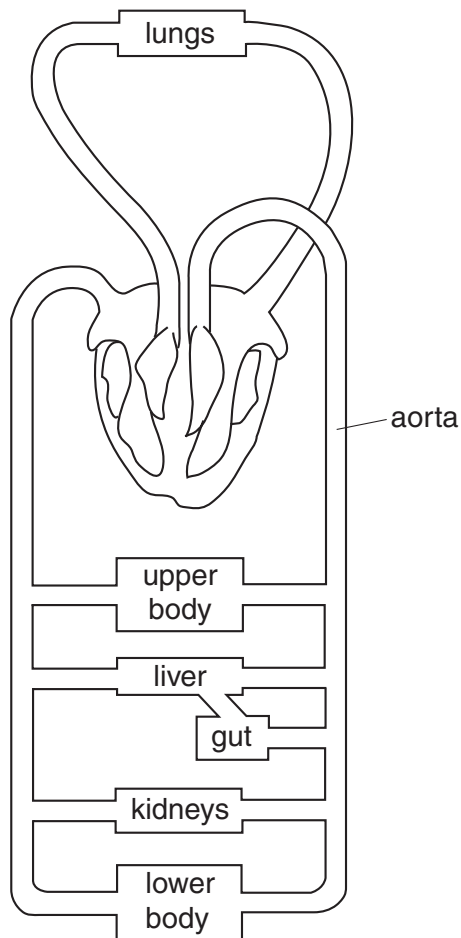

How many times does blood from the kidneys pass through the heart on its way to the aorta?

- A one
- B two
- C four
- D more than four

7 What happens during anaerobic respiration in muscle cells?

	oxygen used	waste products
A	no	carbon dioxide and water
B	no	lactic acid
C	yes	carbon dioxide and water
D	yes	lactic acid

8 The diagram shows part of the alimentary canal and some other organs in the abdomen.

Which is the pancreas?

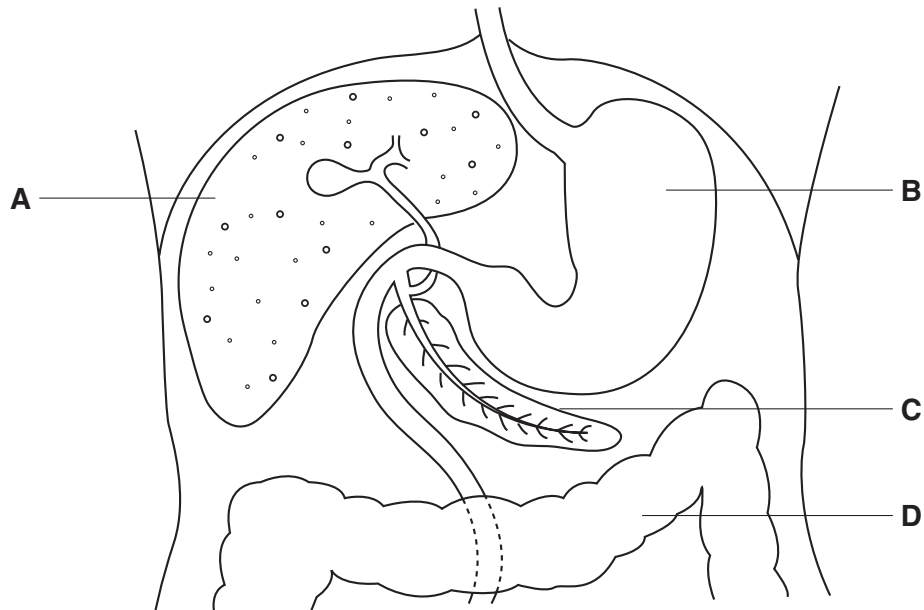

9 Food tests were performed on four substances.

Which substance contained oil and protein?

substance	test reagent			
	Benedict's	biuret	ethanol	iodine
A	✓	✗	✗	✓
B	✓	✓	✗	✗
C	✗	✓	✓	✗
D	✗	✗	✓	✓

10 Where does fertilisation take place in a flowering plant?

- A anther
- B bud
- C ovule
- D stigma

11 The diagram shows the male reproductive system.

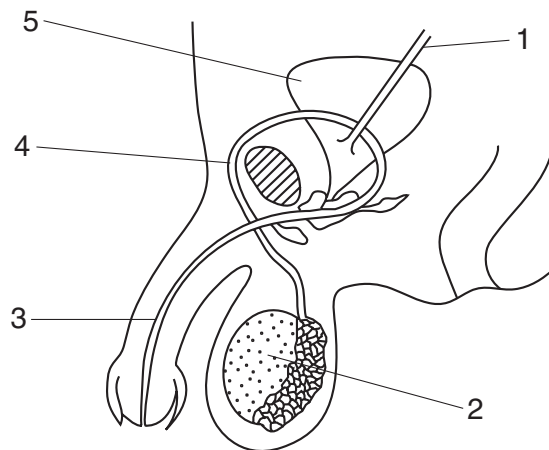

Which path is taken by sperms?

A	1	→	5	→	2
B	1	→	5	→	3
C	2	→	4	→	3
D	2	→	5	→	3

12 The genotype of a human albino is homozygous recessive. Phenotypically normal parents have one albino child.

What is the probability of their next child also being an albino?

- A** 25%
- B** 33%
- C** 50%
- D** 75%

13 The diagram shows the flow of energy in a food chain.

Which organism is the producer in the food chain?

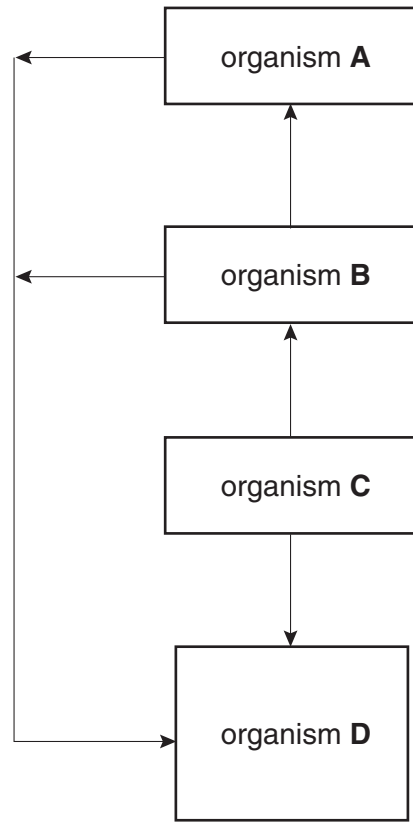

14 The diagram shows the sequence of structures involved in a human response to a change in temperature.

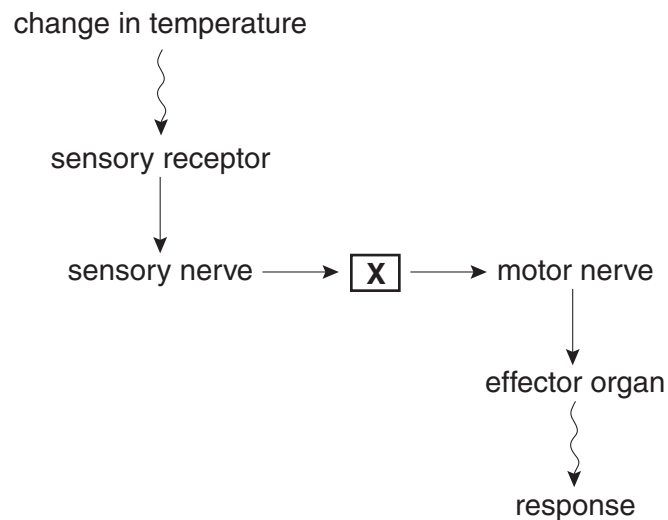

What is represented by box X?

- A blood system
- B central nervous system
- C digestive system
- D endocrine system

- 15 The diagram shows a sack containing a mixture of three minerals.

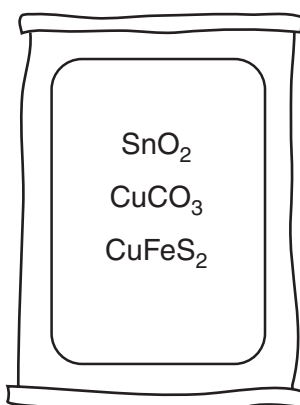

Which element is **not** present in the mixture?

- A cobalt
 - B copper
 - C iron
 - D tin
- 16 Heating a metal compound in a Bunsen flame turns the flame green.

Which metal ion is present in the compound?

- A calcium
 - B copper
 - C potassium
 - D sodium
- 17 In a Group, all the elements are solid at room temperature. The reactivity of the elements increases down the Group.

Which statements about this Group of elements and their oxides are correct?

	the elements are in	their oxides are
A	Group I	acidic
B	Group I	basic
C	Group VII	acidic
D	Group VII	basic

18 Which molecules join into long chains to make proteins?

- A amino acids
- B ethene
- C glucose
- D starch

19 Two tests are done on material Y.

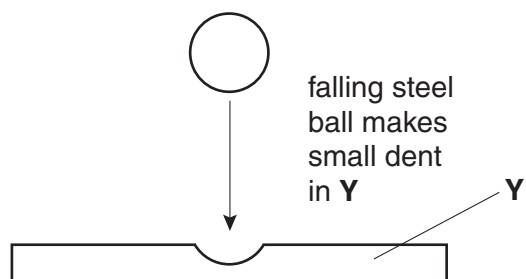
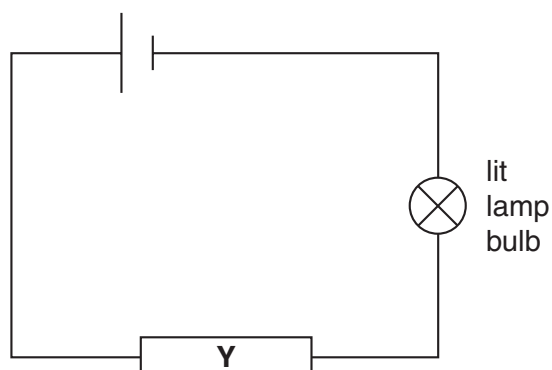

The tests show that Y conducts electricity and is hard.

What could Y be?

- A brass
 - B diamond
 - C glass
 - D graphite
- 20 Iron is manufactured in a blast furnace.

Which of the waste gases from the blast furnace is both non-toxic and unreactive?

- A carbon dioxide
- B carbon monoxide
- C nitrogen
- D sulphur dioxide

21 The results of putting pieces of litmus paper into four solutions are shown.

Which solution contains chlorine?

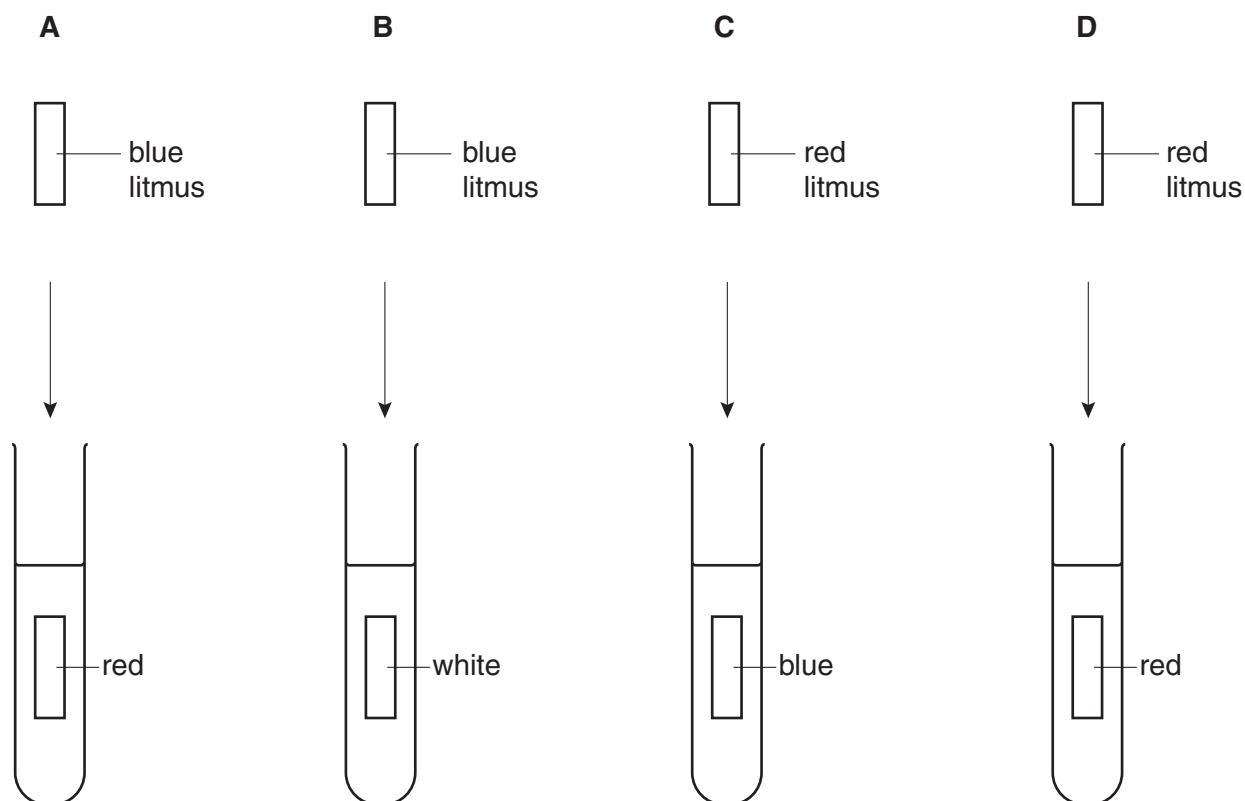

22 Some oil and salt are spilt on to a shirt.

A student uses a non-aqueous organic solvent to try to clean the shirt.

Which substances are likely to be cleaned from the shirt?

- A oil only
- B salt only
- C both oil and salt
- D neither oil or salt

23 What could be the pH values of the solutions in the table?

	acidic	alkaline	neutral
A	9	5	7
B	7	9	5
C	5	9	7
D	5	7	9

24 In which form do plants receive essential elements from fertilisers?

- A atoms
- B carbohydrates
- C ions
- D proteins

25 Why is an analgesic used in medicine?

- A as a painkiller
- B as a vitamin
- C to kill bacteria
- D to kill viruses

26 The element sulphur forms a colloid with water.

How are the sulphur particles held in the water and how do the particles affect a light beam shone on to the colloid?

	the particles are	the light beam is
A	dissolved	refracted
B	dissolved	scattered
C	suspended	refracted
D	suspended	scattered

27 An element is in Group III of the Periodic Table.

What happens to an atom of this element when it forms an ion?

- A It gains three electrons.
- B It gains five electrons.
- C It loses three electrons.
- D It loses five electrons.

28 Five telegraph poles are positioned at equal distances along the side of a road.

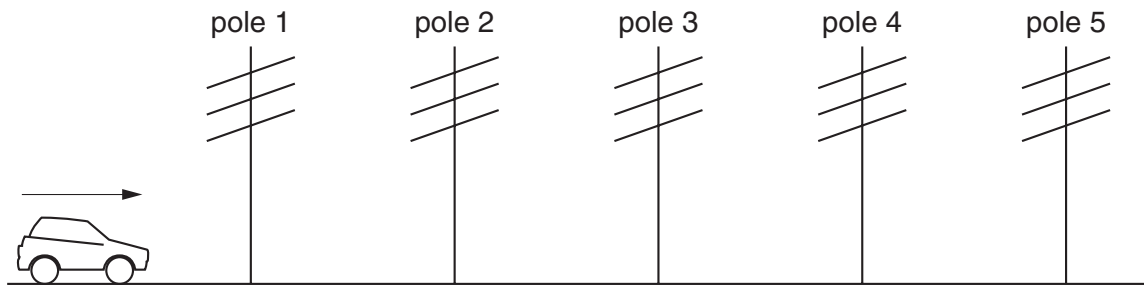

A car accelerates until it is level with pole 4. The car then continues along the road at a steady speed. The times taken to travel between one pole and the next are measured.

Which time is the greatest?

The time between

- A pole 1 and pole 2.
- B pole 2 and pole 3.
- C pole 3 and pole 4.
- D pole 4 and pole 5.

29 A student tries to find the density of a metal block. First he measures the weight with a forcemeter (spring balance). Next he measures the sides of the block using a rule, in order to calculate the volume of the block. Finally he divides the weight by the volume to find the density.

The student has made a mistake.

Why does his method **not** give the density?

- A Density is volume divided by weight.
- B He should have measured the surface area, not the volume.
- C He should have used the mass in his calculation, not the weight.
- D Weight is not measured with a forcemeter (spring balance).

30 A large electric motor is used to lift a container off a ship.

Which of the following values are enough to allow the power of the motor to be calculated?

- A the mass of the container and the distance moved
- B the force used and the distance moved
- C the current used and the work done
- D the work done and the time taken

31 Which diagram shows the child exerting **least** pressure on the ground?

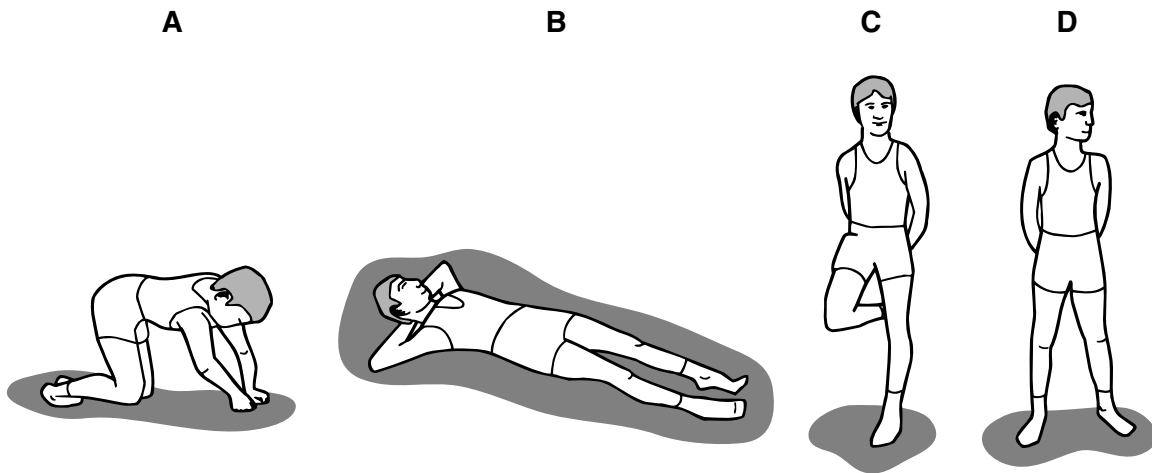

32 There is a vacuum between the double walls of a vacuum flask.

Which types of heat transfer are reduced by the vacuum?

- A conduction and convection
- B conduction and radiation
- C convection and radiation
- D conduction, convection and radiation

33 Waves travel more slowly on the surface of water when the water is shallow.

A person drops a stone into a pool at **X**. The diagram shows the first wavefront on the surface of the pool.

Which region of the pool is likely to be most shallow?

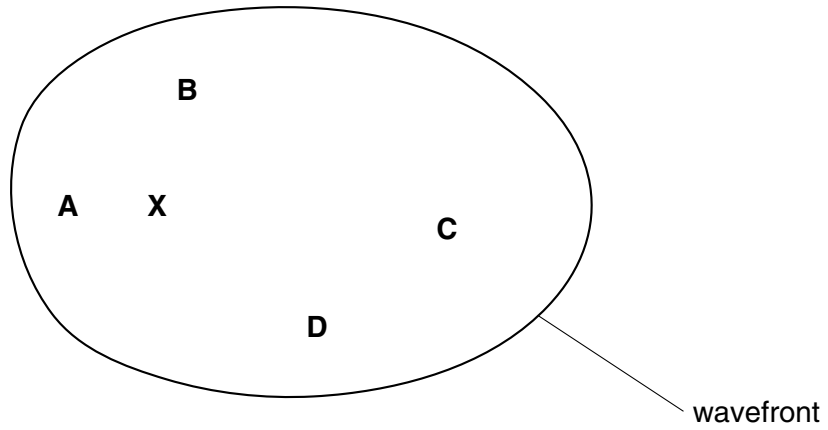

34 Which diagram shows the correct order of the waves in the electromagnetic spectrum?

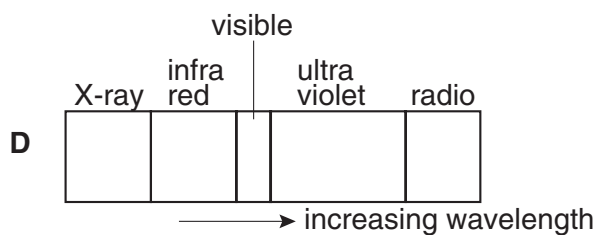
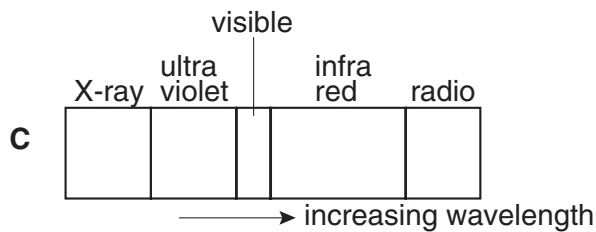
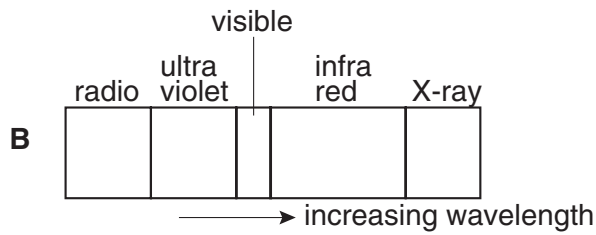
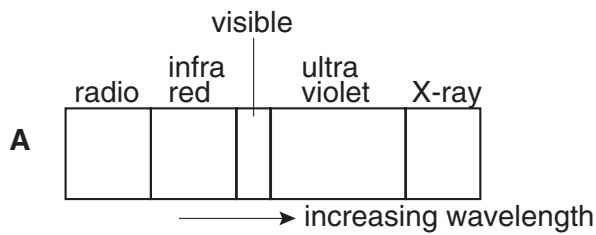

- 35 Astronaut 1 uses a hammer to mend a satellite in space. Astronaut 2 is nearby. There is no atmosphere in space.

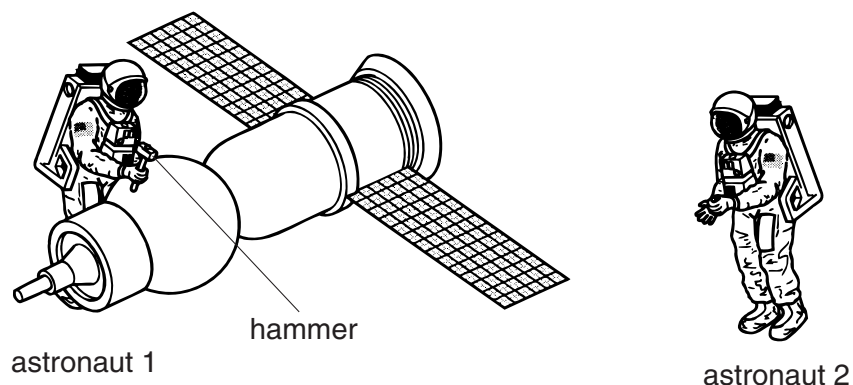

Compared with the sound heard if they were working on Earth, what does astronaut 2 hear?

- A no sound at all
 B a quieter sound
 C a sound of the same loudness
 D a louder sound
- 36 A steel ball on a horizontal wooden table rolls near the north pole of a bar magnet that is lying on the table.

Which diagram shows the most likely path of the ball, as seen from above the table?

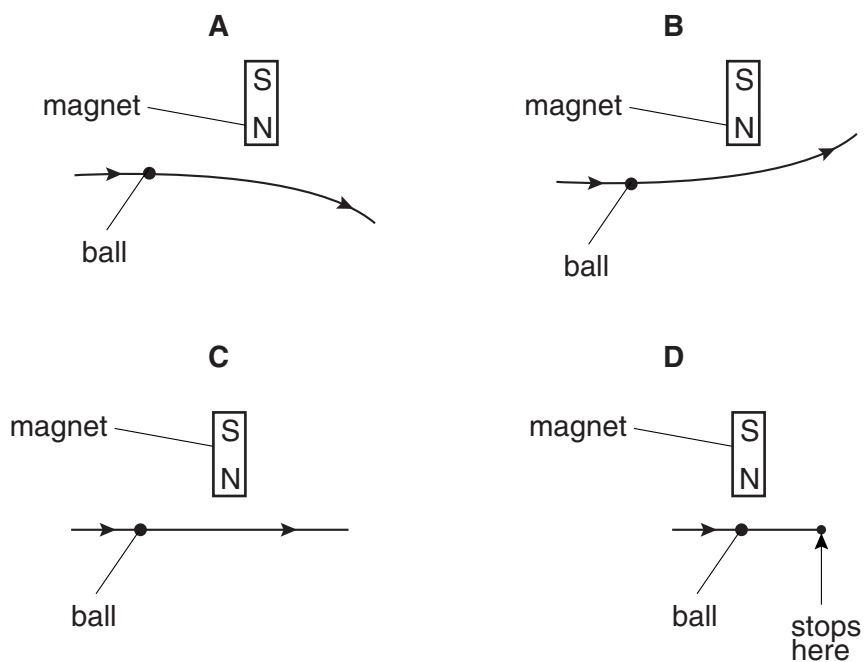

37 A student wants to find the resistance of resistor R using a voltmeter and an ammeter.

Which circuit should the student use?

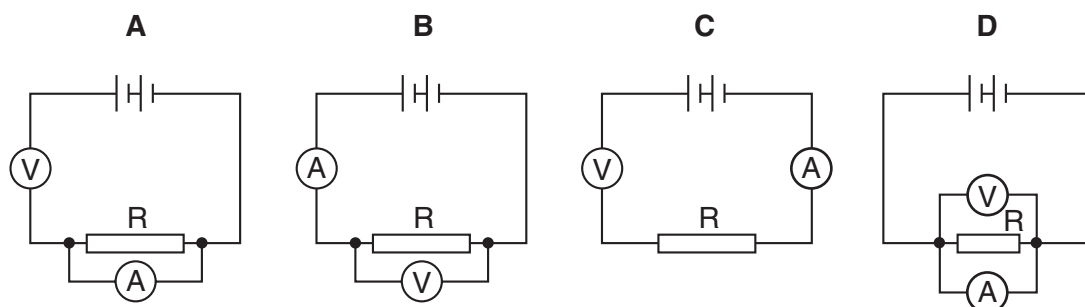

38 A $3.0\ \Omega$ lamp and a $6.0\ \Omega$ lamp are connected in series.

What is the total resistance of the combination?

- A $0.5\ \Omega$
- B $2.0\ \Omega$
- C $9.0\ \Omega$
- D $18.0\ \Omega$

39 How is electricity transmitted over large distances and why is it transmitted in this way?

	how	why
A	at high voltage	for safety
B	at high voltage	to reduce energy loss
C	at low voltage	for safety
D	at low voltage	to reduce energy loss

40 In a cathode-ray tube, particles are given off from a hot cathode by thermionic emission.

Which particles are given off?

- A atoms
- B electrons
- C ions
- D protons

BLANK PAGE

DATA SHEET
The Periodic Table of the Elements

		Group																					
I	II	III	IV	V	VI	VII	O																
7 Li Lithium 3	9 Be Beryllium 4	<table border="1" style="width: 100%; border-collapse: collapse; text-align: center;"> <tr> <td>1 H Hydrogen 1</td> <td colspan="10"></td> </tr> </table>										1 H Hydrogen 1											4 He Helium 2
1 H Hydrogen 1																							
23 Na Sodium 11	24 Mg Magnesium 12	11 B Boron 5	12 C Carbon 6	14 N Nitrogen 7	16 O Oxygen 8	19 F Fluorine 9	20 Ne Neon 10	27 Al Aluminium 13	28 Si Silicon 14	31 P Phosphorus 15	32 S Sulphur 16	35.5 Cl Chlorine 17	40 Ar Argon 18										
39 K Potassium 19	40 Ca Calcium 20	51 V Vanadium 23	48 Ti Titanium 22	55 Mn Manganese 25	56 Fe Iron 26	59 Co Cobalt 27	59 Ni Nickel 28	64 Cu Copper 29	65 Zn Zinc 30	70 Ga Gallium 31	73 Ge Germanium 32	75 As Arsenic 33	79 Se Selenium 34	84 Kr Krypton 36									
85 Rb Rubidium 37	88 Sr Strontium 38	93 Nb Niobium 41	91 Zr Zirconium 40	96 Mo Molybdenum 42	101 Ru Ruthenium 44	103 Rh Rhodium 45	106 Pd Palladium 46	108 Ag Silver 47	112 Cd Cadmium 48	115 In Indium 49	119 Sn Tin 50	122 Sb Antimony 51	128 Te Tellurium 52	131 Xe Xenon 54									
133 Cs Caesium 55	137 Ba Barium 56	181 Ta Tantalum 73	178 Hf Hafnium 72	184 W Tungsten 74	190 Os Osmium 76	192 Ir Iridium 77	195 Pt Platinum 78	197 Au Gold 79	201 Hg Mercury 80	204 Tl Thallium 81	207 Pb Lead 82	209 Bi Bismuth 83	210 Po Polonium 84	222 Rn Radon 86									
87 Fr Francium	88 Ra Radium	226 Ac Actinium																					
		140 Ce Cerium 58	141 Pr Praseodymium 59	144 Nd Neodymium 60	144 Pm Promethium 61	150 Sm Samarium 62	152 Eu Europium 63	157 Gd Gadolinium 64	159 Tb Terbium 65	162 Dy Dysprosium 66	165 Ho Holmium 67	167 Er Erbium 68	169 Tm Thulium 69	173 Yb Ytterbium 70	175 Lu Lutetium 71								
		232 Th Thorium 90	232 Pa Protactinium 91	238 U Uranium 92	238 Np Neptunium 93	244 Pu Plutonium 94	244 Am Americium 95	244 Cm Curium 96	247 Bk Berkelium 97	251 Cf Californium 98	252 Es Einsteinium 99	254 Fm Fermium 100	258 Md Mendelevium 101	259 No Nobelium 102	261 Lr Lawrencium 103								

*58-71 Lanthanoid series
†90-103 Actinoid series

a	X
a = relative atomic mass	
X = atomic symbol	
b = proton (atomic) number	

The volume of one mole of any gas is 24 dm³ at room temperature and pressure (r.t.p.).