



UNIVERSITY OF CAMBRIDGE INTERNATIONAL EXAMINATIONS
International General Certificate of Secondary Education

COMBINED SCIENCE

0653/13

Paper 1 Multiple Choice

October/November 2010

45 minutes

Additional Materials: Multiple Choice Answer Sheet
Soft clean eraser
Soft pencil (type B or HB is recommended)



READ THESE INSTRUCTIONS FIRST

Write in soft pencil.

Do not use staples, paper clips, highlighters, glue or correction fluid.

Write your name, Centre number and candidate number on the Answer Sheet in the spaces provided unless this has been done for you.

There are **forty** questions on this paper. Answer **all** questions. For each question there are four possible answers **A, B, C** and **D**.

Choose the **one** you consider correct and record your choice in **soft pencil** on the separate Answer Sheet.

Read the instructions on the Answer Sheet very carefully.

Each correct answer will score one mark. A mark will not be deducted for a wrong answer.

Any rough working should be done in this booklet.

A copy of the Periodic Table is printed on page **20**.

This document consists of **17** printed pages and **3** blank pages.



1 Which part of a plant cell contains starch grains?

- A cell wall
- B chloroplasts
- C nucleus
- D vacuole

2 The diagram shows a section through a leaf.

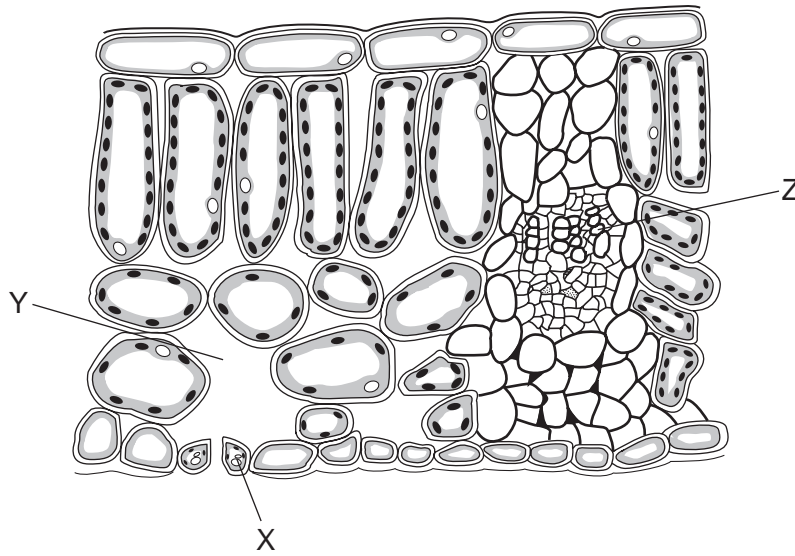

What are X, Y and Z?

	X	Y	Z
A	epidermis cell	air space	phloem
B	epidermis cell	stoma	xylem
C	guard cell	air space	xylem
D	guard cell	stoma	phloem

3 When a plant cell is placed in a dilute solution of red dye, the contents of the cell do not become red.

What prevents the dye molecules from entering the cell?

- A cell surface membrane
- B chloroplasts
- C cytoplasm
- D vacuole

4 Which is correct for all enzymes?

	made of proteins	made inside cells
A	✓	✓
B	✓	x
C	x	✓
D	x	x

5 Which blood vessel carries oxygenated blood away from the heart?

- A** aorta
- B** pulmonary artery
- C** pulmonary vein
- D** vena cava

6 The diagram shows an alveolus and one of its capillaries.

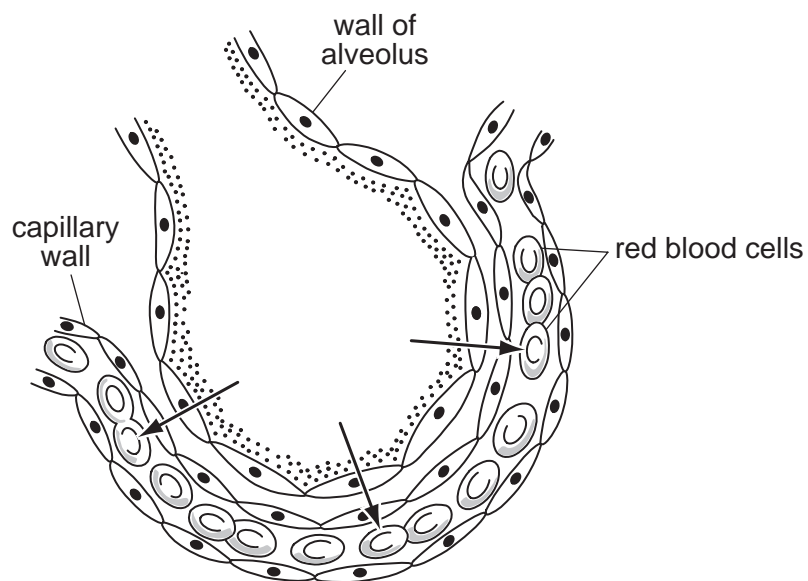

What moves in the direction shown by the arrows?

- A** carbon dioxide
- B** hydrogen
- C** oxygen
- D** water

7 The diagram shows a section through a leaf. The arrows show water movement.

Where does the water evaporate?

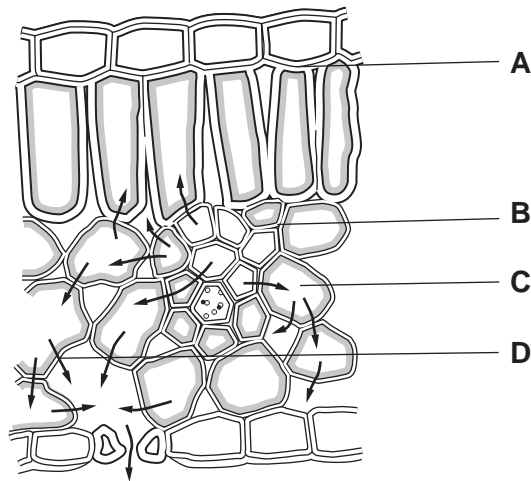

8 What is the stimulus for insulin secretion and what is the effect of insulin on the liver?

	stimulus for secretion	effect on the liver
A	high blood glucose	decreased glucose uptake
B	high blood glucose	increased glucose uptake
C	low blood glucose	decreased glucose uptake
D	low blood glucose	increased glucose uptake

9 Which nutrient, when deficient in the diet, causes a lack of haemoglobin in red blood cells?

- A** calcium
- B** iron
- C** vitamin C
- D** vitamin D

10 Which variation amongst humans is **not** affected by diet?

- A** blood group
- B** bone strength
- C** height
- D** speed of wound healing

11 The diagram shows the uterus and stages in the formation and implantation of a human embryo.

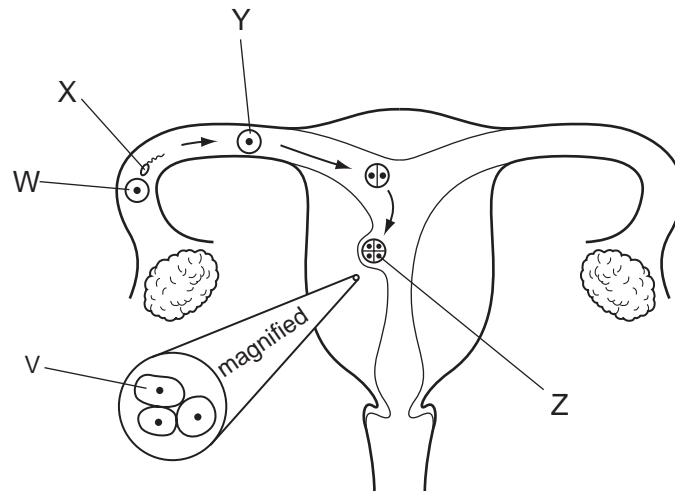

Which cells are genetically identical?

- A** W and Z **B** X and V **C** X and Y **D** Y and Z

12 The table shows the names of plant reproductive structures.

Which does **not** link a structure with what it contains?

	structure	what it contains
A	anther	pollen grain
B	fruit	seed
C	seed	embryo
D	style	ovule

13 The chart shows four stages in the purification of drinking water.

Which stage sterilises the water?

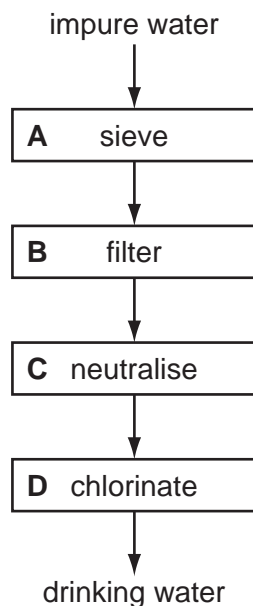

14 What will increase soil erosion?

- A deforestation
- B maintaining natural plant cover
- C reducing grazing by livestock
- D terracing of the land

15 Three students make statements about the differences between elements, compounds and mixtures.

Student 1 All elements exist only as atoms and not molecules.

Student 2 Compounds contain at least two elements.

Student 3 Mixtures consist only of compounds.

Which students are correct?

- A 1 only B 2 only C 3 only D 1, 2 and 3

16 Which three elements are all transition elements?

- A chlorine, bromine and iodine
- B helium, neon and argon
- C iron, cobalt and nickel
- D lithium, sodium and potassium

17 The table shows information about four different compounds.

Which compound contains ionic bonds?

	formula of compound	elements present in compound
A	CO ₂	carbon, oxygen
B	HCl	hydrogen, chlorine
C	NH ₃	nitrogen, hydrogen
D	Na ₂ O	sodium, oxygen

18 Aqueous copper(II) sulfate consists of copper(II) sulfate dissolved in water.

Which apparatus could **not** be used to remove water from this solution?

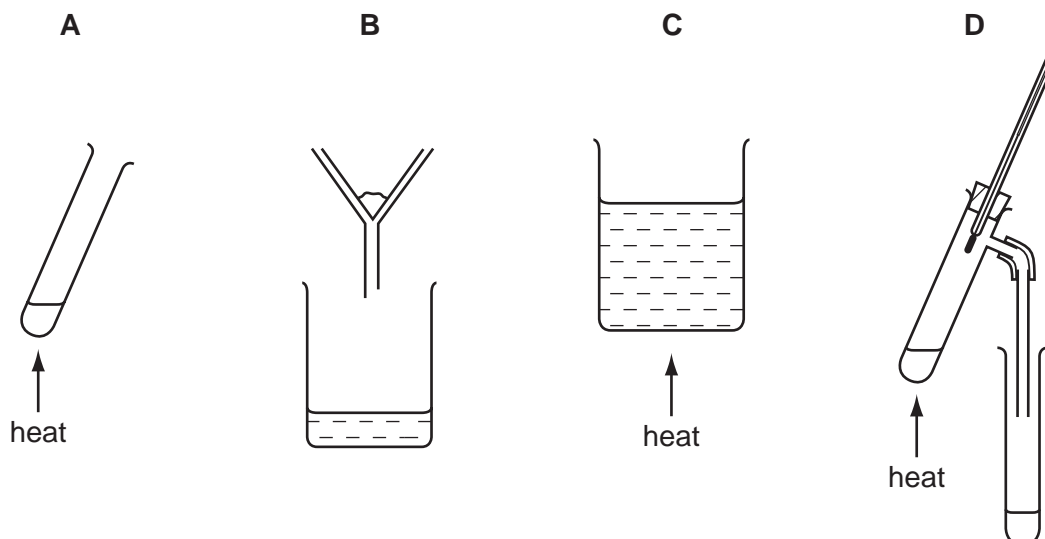

19 Aluminium occurs as aluminium oxide in the ore bauxite.

Which terms apply to the extraction of aluminium from aluminium oxide?

	electrolysis	reduction
A	✓	✓
B	✓	x
C	x	✓
D	x	x

20 The equation represents the reaction of aluminium with sulfuric acid.

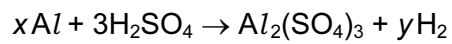

What are the correct values of x and y ?

	x	y
A	2	3
B	2	6
C	3	3
D	3	6

21 An electrolysis circuit is set up using carbon electrodes as shown.

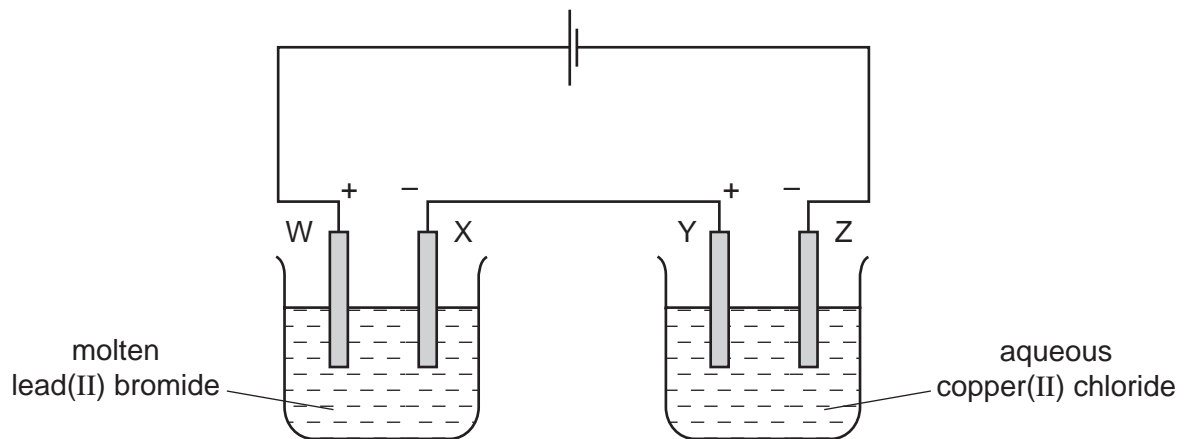

At which two electrodes would a Group VII element be formed?

- A** W and Y **B** W and Z **C** X and Y **D** X and Z

22 Aqueous copper(II) ions, $\text{Cu}^{2+}(\text{aq})$, are blue.

In separate experiments, X and Y, copper powder is added to a test-tube of liquid and the mixture stirred. At the end of each experiment some copper powder remains at the bottom of each tube.

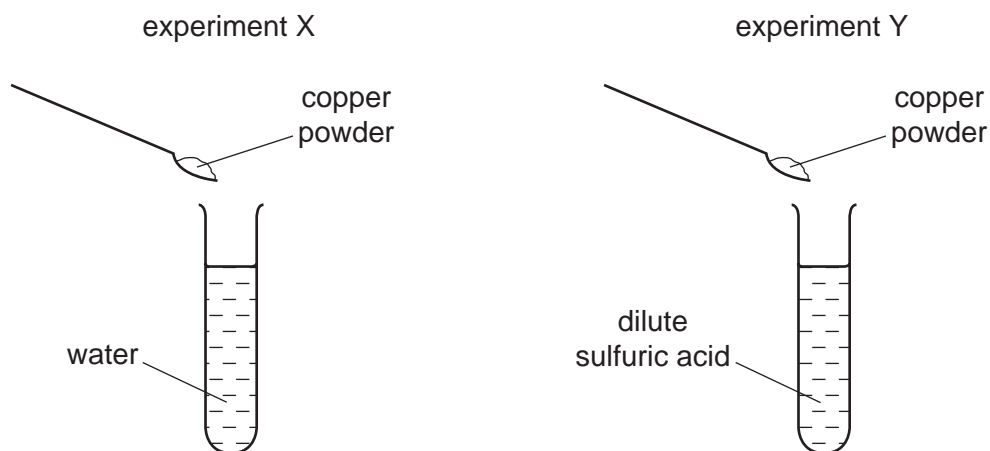

What are the final colours of the liquids above the copper powder?

	experiment X	experiment Y
A	blue	blue
B	blue	colourless
C	colourless	blue
D	colourless	colourless

23 A 250 g portion of potatoes is to be cooked in boiling water.

Which form of the potatoes will require the shortest cooking time?

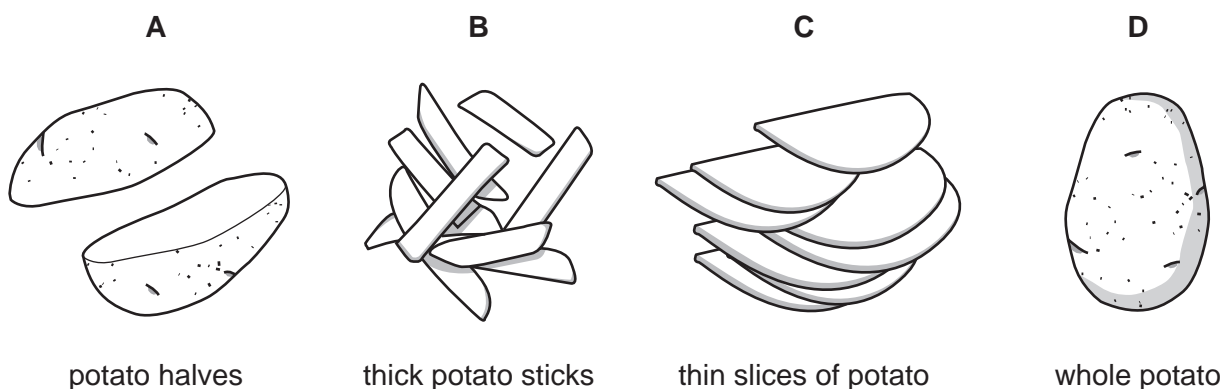

24 The equations for two reactions are shown.

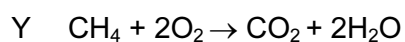
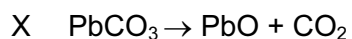

Which types of reaction are X and Y?

	X	Y
A	combustion	neutralisation
B	combustion	thermal decomposition
C	thermal decomposition	combustion
D	thermal decomposition	neutralisation

25 Two products, X and Y, are formed in the complete combustion of methane.

What are X and Y?

- A** carbon and hydrogen
- B** carbon and water
- C** carbon dioxide and hydrogen
- D** carbon dioxide and water

26 Which structure shows a polymer that is also a hydrocarbon?

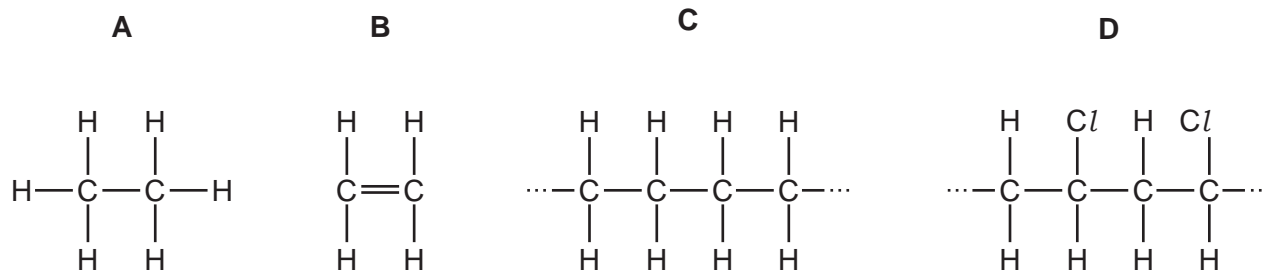

27 Crude oil (petroleum) is heated, using the apparatus shown.

Four fractions, with different boiling point ranges, are collected.

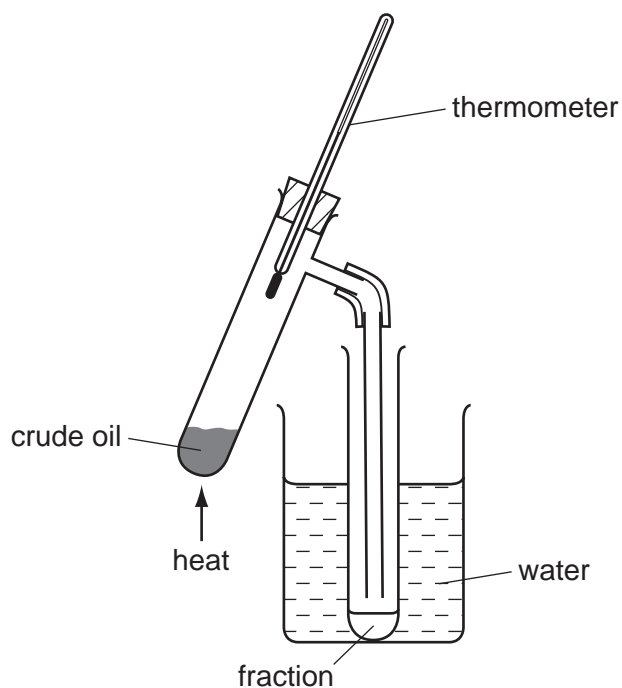

Which term best describes crude oil?

- A a compound
 - B an element
 - C a mixture
 - D a plastic
- 28 Which statement is correct?
- A The mass of a bottle of water at the North Pole is different from its mass at the Equator.
 - B The mass of a bottle of water is measured in newtons.
 - C The weight of a bottle of water and its mass are both measured in kilograms.
 - D The weight of a bottle of water is one of the forces acting on the bottle.

- 29 A ruler and a block of wood are used to find the diameter of some identical metal balls.

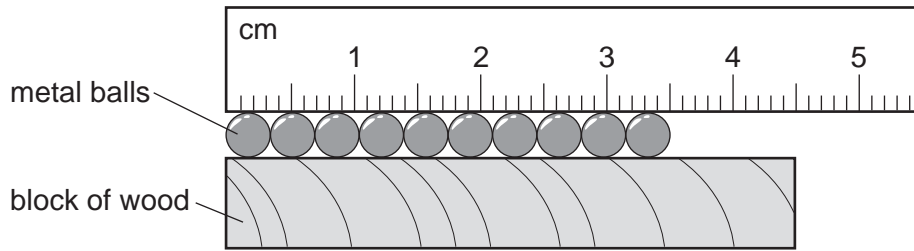

What is the diameter of a single ball?

- A 3.5 mm B 4.5 mm C 3.5 cm D 4.5 cm
- 30 Which substance in the table has the lowest density?

	substance	mass / g	volume / cm ³
A	nylon	1.2	1.0
B	cotton	1.5	1.0
C	olive oil	1.8	2.0
D	water	2.0	2.0

- 31 In a hydroelectric power station, one form of energy is stored in a reservoir. This energy is then transferred in stages to another form, which is the output.

Which row gives the names for the stored energy and the output energy?

	stored energy	output energy
A	electrical	heat
B	electrical	kinetic
C	kinetic	electrical
D	potential	electrical

32 The graph shows how the speed of an object changes over an interval of time.

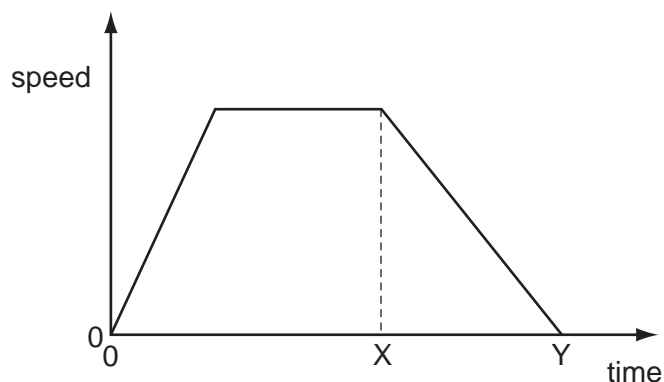

Which statement describes the acceleration of the object between time X and time Y?

- A It is constant.
- B It is decreasing.
- C It is increasing.
- D It is zero.

33 A camper sits beside a fire and quickly begins to feel warm. He pushes the end of a metal rod into the fire and after a while his hand feels the rod getting warm.

Which heat transfers are taking place?

	heat transfer from fire through the air	heat transfer from fire through the rod
A	conduction	convection
B	conduction	radiation
C	radiation	conduction
D	radiation	convection

34 The diagram shows an electrical circuit.

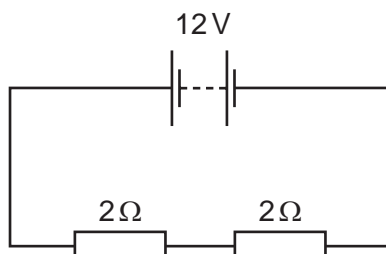

What is the current through the circuit?

- A 3A
- B 4A
- C 12A
- D 24A

- 35 The diagrams show part of an electric circuit containing an ammeter and a voltmeter.

Which arrangement should be used to measure the potential difference (p.d.) across the resistor and the current through it?

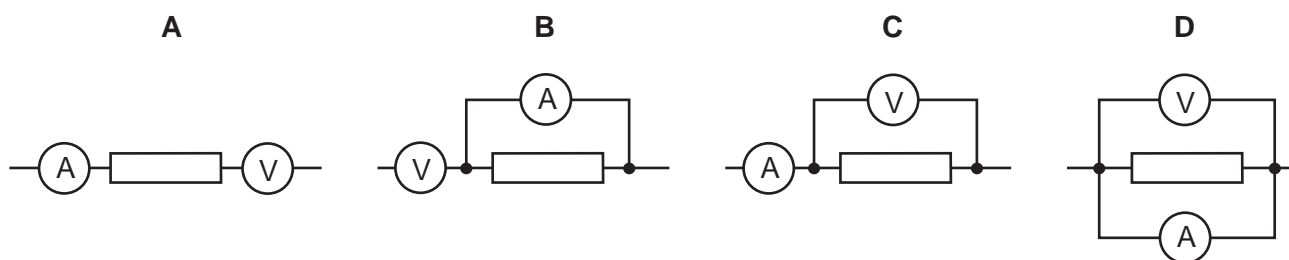

- 36 In the circuit shown, only one of the fuses has blown, but none of the lamps is lit.

Which fuse has blown?

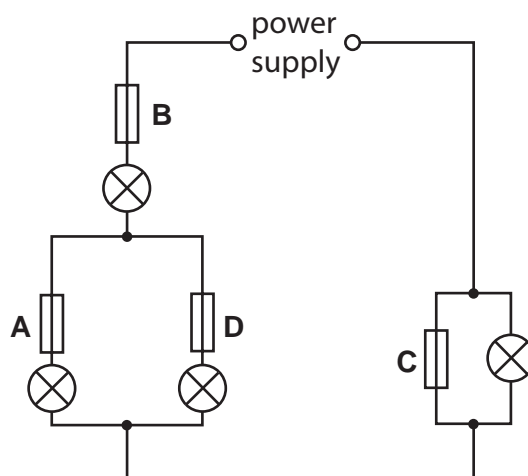

- 37 A police car with its siren sounding is stationary in heavy traffic. A pedestrian notices that, although the loudness of the sound produced does not change, the pitch varies.

Which row in the table describes the amplitude and the frequency of the sound?

	amplitude	frequency
A	constant	constant
B	constant	varying
C	varying	constant
D	varying	varying

38 The Sun heats the Earth by electromagnetic radiation.

Which region of the electromagnetic spectrum is responsible for most of this heating?

- A microwave
- B infra-red
- C ultraviolet
- D X-ray

39 A source of light is placed at the focus F of a converging lens. The focal length of the lens is f .

Which diagram shows the path of the rays of light that pass through the lens?

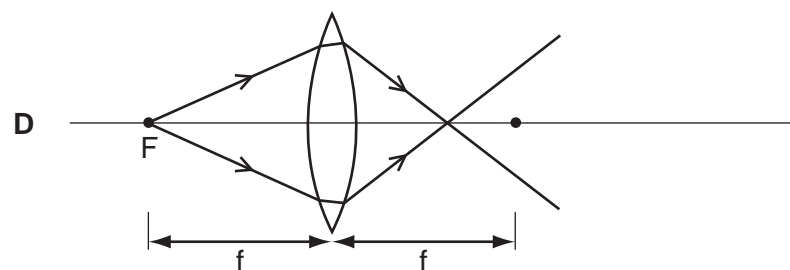
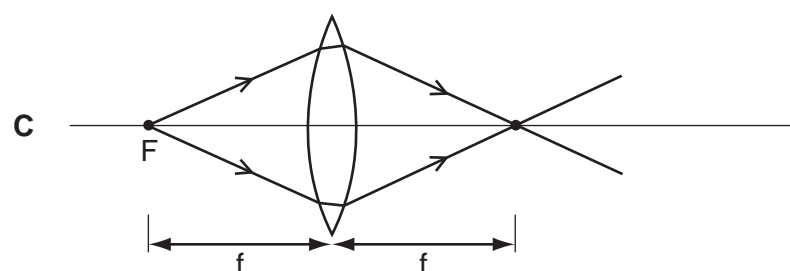
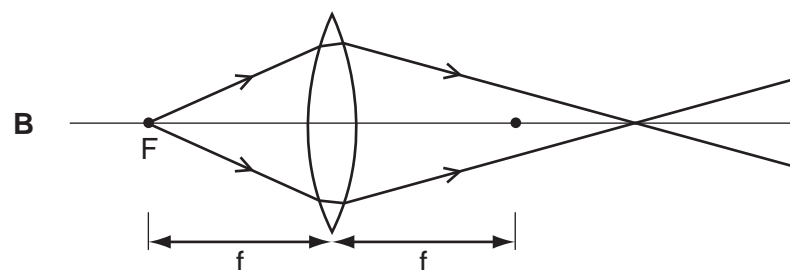
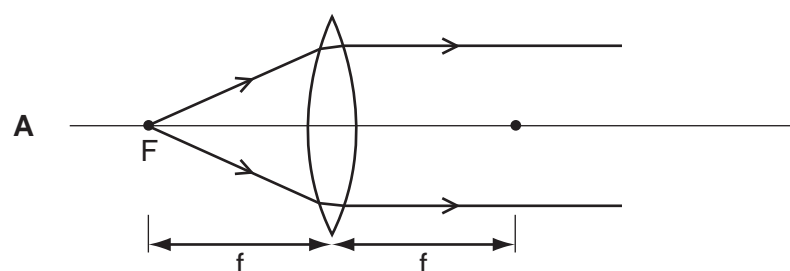

40 Which row in the table describes alpha-particles?

	electric charge	penetrates 1 cm of aluminium?
A	negative	yes
B	negative	no
C	positive	yes
D	positive	no

DATA SHEET
The Periodic Table of the Elements

		Group															
		I	II	III	IV	V	VI	VII	VIII	IX	X						
		1 H Hydrogen 1															
		4 He Helium 2															
7	9	3	4	5	6	7	8	9	10	11	12	13	14	15	16	17	18
Li Lithium	Be Beryllium	B Boron	C Carbon	N Nitrogen	O Oxygen	F Fluorine	Ne Neon	Na Sodium	Mg Magnesium	Al Aluminium	Si Silicon	P Phosphorus	S Sulfur	Cl Chlorine	Ar Argon	K Potassium	Ca Calcium
19	20	21	22	23	24	25	26	27	28	29	30	31	32	33	34	35	36
K Potassium	Ca Calcium	Sc Scandium	Ti Titanium	V Vanadium	Cr Chromium	Mn Manganese	Fe Iron	Co Cobalt	Ni Nickel	Cu Copper	Zn Zinc	Ga Gallium	Ge Germanium	As Arsenic	Se Selenium	Br Bromine	Kr Krypton
37	38	39	40	41	42	43	44	45	46	47	48	49	50	51	52	53	54
Rb Rubidium	Sr Strontium	Y Yttrium	Zr Zirconium	Nb Niobium	Mo Molybdenum	Tc Technetium	Ru Ruthenium	Rh Rhodium	Pd Palladium	Ag Silver	Cd Cadmium	In Indium	Sn Tin	Sb Antimony	Te Tellurium	I Iodine	Xe Xenon
55	56	57	72	73	74	75	76	77	78	79	80	81	82	83	84	85	86
Cs Caesium	Ba Barium	La Lanthanum	Hf Hafnium	Ta Tantalum	W Tungsten	Re Rhenium	Os Osmium	Ir Iridium	Pt Platinum	Au Gold	Hg Mercury	Tl Thallium	Pb Lead	Bi Bismuth	Po Polonium	At Astatine	Rn Radon
87	88	89	†	†	†	†	†	†	†	†	†	†	†	†	†	†	†
Fr Francium	Ra Radium	Ac Actinium															
		*58-71 Lanthanoid series †90-103 Actinoid series															
		58	59	60	61	62	63	64	65	66	67	68	69	70	71	72	73
		Ce Cerium	Pr Praseodymium	Nd Neodymium	Pm Promethium	Sm Samarium	Eu Europium	Gd Gadolinium	Tb Terbium	Dy Dysprosium	Ho Holmium	Er Erbium	Tm Thulium	Yb Ytterbium	Lu Lutetium	Th Thorium	Pa Protactinium
		90	91	92	93	94	95	96	97	98	99	100	101	102	103	104	105
		Th Thorium	Pa Protactinium	U Uranium	Np Neptunium	Pu Plutonium	Am Americium	Cm Curium	Bk Berkelium	Cf Californium	Es Einsteinium	Fm Fermium	Md Mendelevium	No Nobelium	Lr Lawrencium	Ac Actinium	Rf Rutherfordium
		106	107	108	109	110	111	112	113	114	115	116	117	118	119	120	121
		Rg Roentgenium	Cn Copernicium	Nh Nihonium	Ds Darmstadtium	Rg Roentgenium	Uu Ununseptium	Uub Ununbium	Uut Ununtrium	Uuq Ununquadium	Uup Ununpentium	Uuq Ununquadium	Uuh Ununhexium	Uuo Ununoctium	Uuq Ununquadium	Uuh Ununhexium	Uuo Ununoctium

Key

a	X	= relative atomic mass
b	X	= atomic symbol
	X	= proton (atomic) number

The volume of one mole of any gas is 24 dm³ at room temperature and pressure (r.t.p.).

Permission to reproduce items where third-party owned material protected by copyright is included has been sought and cleared where possible. Every reasonable effort has been made by the publisher (UCLES) to trace copyright holders, but if any items requiring clearance have unwittingly been included, the publisher will be pleased to make amends at the earliest possible opportunity.

University of Cambridge International Examinations is part of the Cambridge Assessment Group. Cambridge Assessment is the brand name of University of Cambridge Local Examinations Syndicate (UCLES), which is itself a department of the University of Cambridge.