

Write your name here

Surname

Other names

Pearson Edexcel Certificate

Centre Number

Candidate Number

**Pearson Edexcel
International GCSE**

--	--	--	--	--

--	--	--	--	--

Chinese

Paper 1: Listening

Tuesday 24 May 2016 – Morning

Time: 40 minutes plus 5 minutes reading time

Paper Reference

KCN0/01

4CN0/01

You do not need any other materials.

Total Marks

Instructions

- Use **black** ink or ball-point pen.
- **Fill in the boxes** at the top of this page with your name, centre number and candidate number.
- On page 2 indicate which set of questions you intend to work from, either **TRADITIONAL** or **SIMPLIFIED** characters.
- Answer **all** questions.
- Answer the questions in the spaces provided – *there may be more space than you need.*
- You must **not** use a dictionary.

Information

- You have 5 minutes to read through the paper before the recording starts.
- You will hear each extract twice. You may write at any time during the test. There will be a pause between each question.
- The total mark for this paper is 50.
- The marks for **each** question are shown in brackets – *use this as a guide as to how much time to spend on each question.*

Advice

- Read each question carefully before you start to answer it.
- Try to answer every question.
- Check your answers if you have time at the end.

Turn over ►

P45948A

©2016 Pearson Education Ltd.

1/1/1/1/



PEARSON

Use of Chinese Characters

All passages and questions are printed twice, once in traditional/full characters and once in simplified characters.

Questions in traditional/full characters begin on page 3.

Questions in simplified characters begin on page 23.

You may work from whichever version you wish. Please indicate which set of questions you intend to work from by putting a cross in one box below:

TRADITIONAL/FULL 繁體字	<input type="checkbox"/>
SIMPLIFIED 简体字	<input type="checkbox"/>



DO NOT WRITE IN THIS AREA

DO NOT WRITE IN THIS AREA

DO NOT WRITE IN THIS AREA

繁體字

TRADITIONAL/FULL CHARACTER VERSION

(Simplified Character Version begins on page 23)



TRADITIONAL/FULL CHARACTERS







Answer ALL questions.

Some questions must be answered with a cross in a box ☒. If you change your mind about an answer, put a line through the box ☒ and then mark your new answer with a cross ☒.

1 愛好

他們有什麼愛好？選擇正確答案，在三個空格內打 ☒ 號。

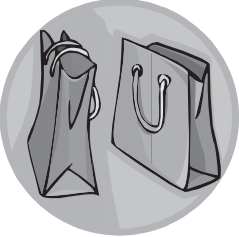
Which hobbies do they have? Put a cross ☒ in the **three** correct boxes.

例: 	A 	B 
<input checked="" type="checkbox"/>	<input type="checkbox"/>	<input type="checkbox"/>
C 	D 	E 
<input type="checkbox"/>	<input type="checkbox"/>	<input type="checkbox"/>

(Total for Question 1 = 3 marks)

DO NOT WRITE IN THIS AREA

DO NOT WRITE IN THIS AREA

DO NOT WRITE IN THIS AREA



TRADITIONAL/FULL CHARACTERS

2 去哪裏

他們去哪裏? 選擇正確答案, 填在空格內。

Where are they going? Write the correct letter in the box.

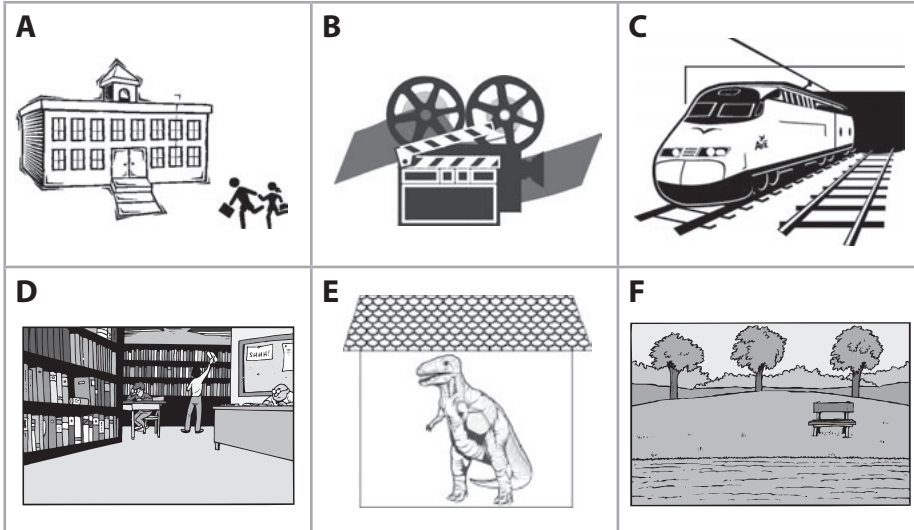

例: 馬田	A
(i) 海倫	
(ii) 大衛	
(iii) 美美	

(Total for Question 2 = 3 marks)

DO NOT WRITE IN THIS AREA

DO NOT WRITE IN THIS AREA

DO NOT WRITE IN THIS AREA



TRADITIONAL/FULL CHARACTERS

3 朋友

同學們談他們的朋友。在適當的空格內打 ☒ 號。

Classmates are talking about their friends. Put a cross ☒ in the correct box.



	A	B	C	D	E	F	G	H
例：馬田	<input type="checkbox"/>	<input type="checkbox"/>	<input checked="" type="checkbox"/>	<input type="checkbox"/>	<input type="checkbox"/>	<input type="checkbox"/>	<input type="checkbox"/>	<input type="checkbox"/>
(i) 海倫	<input type="checkbox"/>	<input type="checkbox"/>	<input type="checkbox"/>	<input type="checkbox"/>	<input type="checkbox"/>	<input type="checkbox"/>	<input type="checkbox"/>	<input type="checkbox"/>
(ii) 大衛	<input type="checkbox"/>	<input type="checkbox"/>	<input type="checkbox"/>	<input type="checkbox"/>	<input type="checkbox"/>	<input type="checkbox"/>	<input type="checkbox"/>	<input type="checkbox"/>
(iii) 美美	<input type="checkbox"/>	<input type="checkbox"/>	<input type="checkbox"/>	<input type="checkbox"/>	<input type="checkbox"/>	<input type="checkbox"/>	<input type="checkbox"/>	<input type="checkbox"/>
(iv) 馬克	<input type="checkbox"/>	<input type="checkbox"/>	<input type="checkbox"/>	<input type="checkbox"/>	<input type="checkbox"/>	<input type="checkbox"/>	<input type="checkbox"/>	<input type="checkbox"/>
(v) 安娜	<input type="checkbox"/>	<input type="checkbox"/>	<input type="checkbox"/>	<input type="checkbox"/>	<input type="checkbox"/>	<input type="checkbox"/>	<input type="checkbox"/>	<input type="checkbox"/>
(vi) 英華	<input type="checkbox"/>	<input type="checkbox"/>	<input type="checkbox"/>	<input type="checkbox"/>	<input type="checkbox"/>	<input type="checkbox"/>	<input type="checkbox"/>	<input type="checkbox"/>

(Total for Question 3 = 6 marks)

DO NOT WRITE IN THIS AREA

DO NOT WRITE IN THIS AREA

DO NOT WRITE IN THIS AREA



DO NOT WRITE IN THIS AREA

DO NOT WRITE IN THIS AREA

DO NOT WRITE IN THIS AREA

BLANK PAGE



TRADITIONAL/FULL CHARACTERS

4 學習生活

大衛是我的朋友。在適當的空格內打 ☒ 號。

David is my friend. Put a cross ☒ in the correct box.

例：大衛今年多大？

A 18	B 19	C 20
☒	☒	☒



(i) 他學習什麼？

A 	B 	C 
☒	☒	☒

(ii) 他什麼時候起牀？

A 8:00	B 8:15	C 8:30
☒	☒	☒

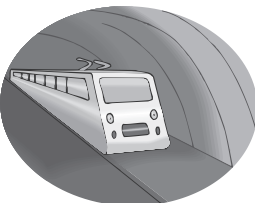
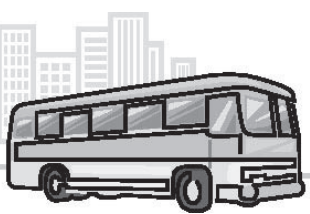
(iii) 他怎麼去學校？

A 	B 	C 
☒	☒	☒

DO NOT WRITE IN THIS AREA



DO NOT WRITE IN THIS AREA

DO NOT WRITE IN THIS AREA



TRADITIONAL/FULL CHARACTERS

(iv) 他將來要做什麼工作？

A 	B 	C 
<input type="checkbox"/>	<input type="checkbox"/>	<input type="checkbox"/>

(v) 他的哥哥在哪裏？

A 中國	B 美國	C 日本
<input type="checkbox"/>	<input type="checkbox"/>	<input type="checkbox"/>

(vi) 大衛什麼時候去旅行？

A 四月	B 十月	C 十二月
<input type="checkbox"/>	<input type="checkbox"/>	<input type="checkbox"/>

(Total for Question 4 = 6 marks)





TRADITIONAL/FULL CHARACTERS

5 酒店

聆聽對話。在適當的空格內打 ☒ 號。

Listen to the conversation. Put a cross ☒ in the correct box.

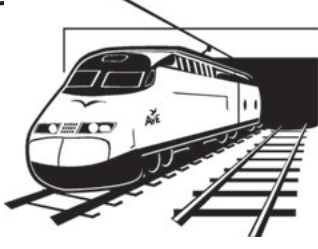

例：她在哪裏？

<p>A</p> 	<p>B</p> 	<p>C</p> 
<p style="text-align: center;">☒</p>	<p style="text-align: center;">☒</p>	<p style="text-align: center;">☒</p>

(i) 她要住幾天？

<p>A</p> <p style="text-align: center;">1</p>	<p>B</p> <p style="text-align: center;">3</p>	<p>C</p> <p style="text-align: center;">6</p>
<p style="text-align: center;">☒</p>	<p style="text-align: center;">☒</p>	<p style="text-align: center;">☒</p>

(ii) 她要給服務員看什麼？

<p>A</p> 	<p>B</p> 	<p>C</p> 
<p style="text-align: center;">☒</p>	<p style="text-align: center;">☒</p>	<p style="text-align: center;">☒</p>



(iii) 早餐幾點結束？

<p>A</p> <p style="text-align: center;">6:00</p>	<p>B</p> <p style="text-align: center;">7:30</p>	<p>C</p> <p style="text-align: center;">9:00</p>
<p style="text-align: center;">☒</p>	<p style="text-align: center;">☒</p>	<p style="text-align: center;">☒</p>

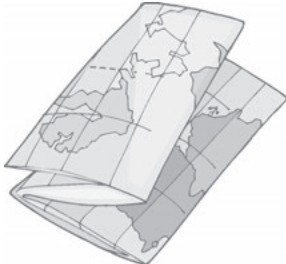

TRADITIONAL/FULL CHARACTERS

(iv) 她想要什麼？

<p>A</p> 	<p>B</p> 	<p>C</p> 
<input type="checkbox"/>	<input type="checkbox"/>	<input type="checkbox"/>

(v) 她要去哪裏？

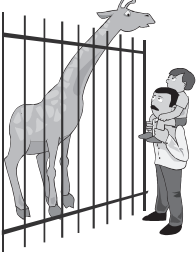
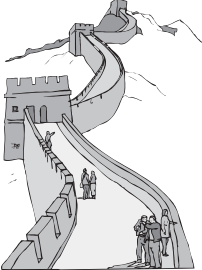
<p>A</p> 	<p>B</p> 	<p>C</p> 
<input type="checkbox"/>	<input type="checkbox"/>	<input type="checkbox"/>

(vi) 要多少錢？

<p>A</p> <p>三十塊</p>	<p>B</p> <p>五十塊</p>	<p>C</p> <p>九十塊</p>
<input type="checkbox"/>	<input type="checkbox"/>	<input type="checkbox"/>

(Total for Question 5 = 6 marks)

DO NOT WRITE IN THIS AREA

DO NOT WRITE IN THIS AREA

DO NOT WRITE IN THIS AREA



TRADITIONAL/FULL CHARACTERS

6 放學以後

同學們談他們今天放學以後做什麼。在適當的空格內打 ☒ 號。

Classmates are talking about what they will do today after school. Put a cross ☒ in the correct box.

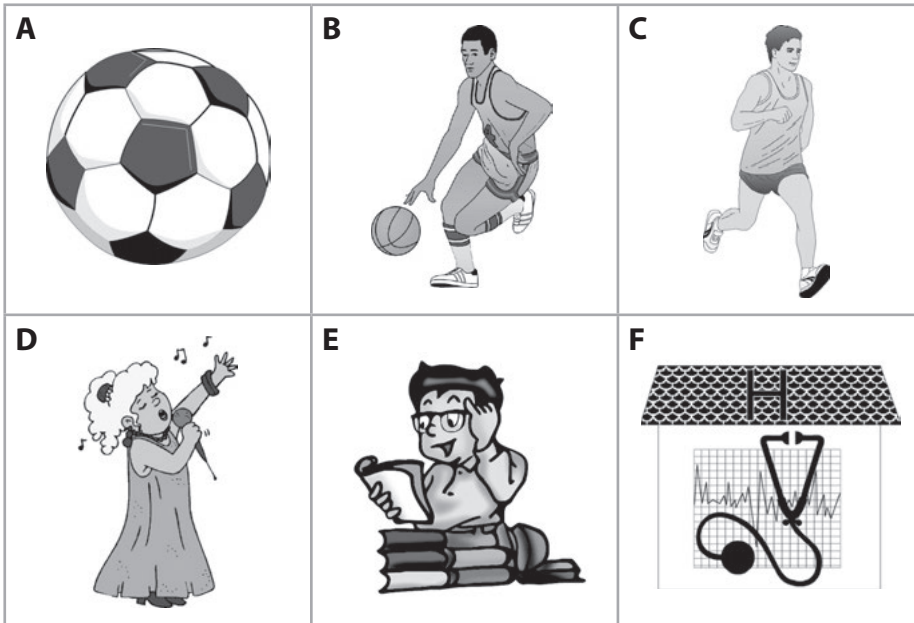

	A	B	C	D	E	F
例：馬田	<input type="checkbox"/>	<input checked="" type="checkbox"/>	<input type="checkbox"/>	<input type="checkbox"/>	<input type="checkbox"/>	<input type="checkbox"/>
(i) 海倫	<input type="checkbox"/>	<input type="checkbox"/>	<input type="checkbox"/>	<input type="checkbox"/>	<input type="checkbox"/>	<input type="checkbox"/>
(ii) 大衛	<input type="checkbox"/>	<input type="checkbox"/>	<input type="checkbox"/>	<input type="checkbox"/>	<input type="checkbox"/>	<input type="checkbox"/>
(iii) 美美	<input type="checkbox"/>	<input type="checkbox"/>	<input type="checkbox"/>	<input type="checkbox"/>	<input type="checkbox"/>	<input type="checkbox"/>
(iv) 馬克	<input type="checkbox"/>	<input type="checkbox"/>	<input type="checkbox"/>	<input type="checkbox"/>	<input type="checkbox"/>	<input type="checkbox"/>

(Total for Question 6 = 4 marks)

DO NOT WRITE IN THIS AREA

DO NOT WRITE IN THIS AREA

DO NOT WRITE IN THIS AREA



DO NOT WRITE IN THIS AREA

DO NOT WRITE IN THIS AREA

DO NOT WRITE IN THIS AREA

BLANK PAGE





TRADITIONAL/FULL CHARACTERS

7 東西不見了



東東很不高興。在適當的空格內打 ☒ 號。

Dongdong is unhappy. Put a cross ☒ in the correct box.

例：東東怎麼了？

<p>A</p> 	<p>B</p> 	<p>C</p> 
<input type="checkbox"/>	<input checked="" type="checkbox"/>	<input type="checkbox"/>

(i) 什麼不見了？

<p>A</p> 	<p>B</p> 	<p>C</p> 
<input type="checkbox"/>	<input type="checkbox"/>	<input type="checkbox"/>

(ii) 他幾點回家？

<p>A</p> <p>三點</p>	<p>B</p> <p>七點</p>	<p>C</p> <p>八點</p>
<input type="checkbox"/>	<input type="checkbox"/>	<input type="checkbox"/>



TRADITIONAL/FULL CHARACTERS

(iii) 誰會生氣？

A	媽媽	B	同學	C	爸爸
	<input type="checkbox"/>		<input type="checkbox"/>		<input type="checkbox"/>

(Total for Question 7 = 3 marks)

DO NOT WRITE IN THIS AREA

DO NOT WRITE IN THIS AREA

DO NOT WRITE IN THIS AREA







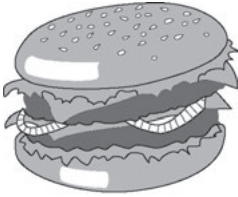

TRADITIONAL/FULL CHARACTERS

8 中國餐廳

同學們在中國餐廳點菜。在適當的空格內打☒號。

Classmates are ordering food in a Chinese restaurant. Put a cross ☒ in the correct box.

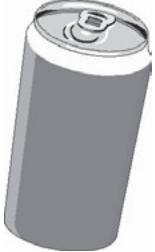
<p>A</p> 	<p>B</p> 	<p>C</p> 	<p>D</p> 
<p>E</p> 	<p>F</p>  <p>© Image navi - Sozajiten / Alamy Stock Photo</p>	<p>G</p> 	<p>H</p> 

	A	B	C	D	E	F	G	H
例：馬田	<input checked="" type="checkbox"/>	<input type="checkbox"/>	<input type="checkbox"/>	<input type="checkbox"/>	<input type="checkbox"/>	<input type="checkbox"/>	<input type="checkbox"/>	<input type="checkbox"/>
(i) 安娜	<input type="checkbox"/>	<input type="checkbox"/>	<input type="checkbox"/>	<input type="checkbox"/>	<input type="checkbox"/>	<input type="checkbox"/>	<input type="checkbox"/>	<input type="checkbox"/>
(ii) 大衛	<input type="checkbox"/>	<input type="checkbox"/>	<input type="checkbox"/>	<input type="checkbox"/>	<input type="checkbox"/>	<input type="checkbox"/>	<input type="checkbox"/>	<input type="checkbox"/>
(iii) 海倫	<input type="checkbox"/>	<input type="checkbox"/>	<input type="checkbox"/>	<input type="checkbox"/>	<input type="checkbox"/>	<input type="checkbox"/>	<input type="checkbox"/>	<input type="checkbox"/>
(iv) 馬克	<input type="checkbox"/>	<input type="checkbox"/>	<input type="checkbox"/>	<input type="checkbox"/>	<input type="checkbox"/>	<input type="checkbox"/>	<input type="checkbox"/>	<input type="checkbox"/>
(v) 美美	<input type="checkbox"/>	<input type="checkbox"/>	<input type="checkbox"/>	<input type="checkbox"/>	<input type="checkbox"/>	<input type="checkbox"/>	<input type="checkbox"/>	<input type="checkbox"/>
(vi) 英華	<input type="checkbox"/>	<input type="checkbox"/>	<input type="checkbox"/>	<input type="checkbox"/>	<input type="checkbox"/>	<input type="checkbox"/>	<input type="checkbox"/>	<input type="checkbox"/>

(Total for Question 8 = 6 marks)

DO NOT WRITE IN THIS AREA

DO NOT WRITE IN THIS AREA

DO NOT WRITE IN THIS AREA



DO NOT WRITE IN THIS AREA

DO NOT WRITE IN THIS AREA

DO NOT WRITE IN THIS AREA

BLANK PAGE



TRADITIONAL/FULL CHARACTERS

9 暑期工作

老師和學生在說話。在適當的空格內打 ☒ 號。

A teacher and her student are talking. Put a cross ☒ in the correct box.

例：學校什麼時候放假？

A 明天	B 星期一	C 下個星期六
<input type="checkbox"/>	<input type="checkbox"/>	<input checked="" type="checkbox"/>

(i) 他想買什麼？

A 自行車	B 電腦	C 電子遊戲
<input type="checkbox"/>	<input type="checkbox"/>	<input type="checkbox"/>

(ii) 他喜歡什麼？

A 動物	B 書	C 鞋
<input type="checkbox"/>	<input type="checkbox"/>	<input type="checkbox"/>

(iii) 他可以教什麼？

A 中文	B 數學	C 化學
<input type="checkbox"/>	<input type="checkbox"/>	<input type="checkbox"/>

DO NOT WRITE IN THIS AREA

DO NOT WRITE IN THIS AREA

DO NOT WRITE IN THIS AREA



TRADITIONAL/FULL CHARACTERS

(iv) 他什麼時候工作？

A 星期一和星期四	B 星期二和星期三	C 星期二和星期五
<input type="checkbox"/>	<input type="checkbox"/>	<input type="checkbox"/>

(v) 每次多少錢？

A 五鎊	B 七鎊	C 十鎊
<input type="checkbox"/>	<input type="checkbox"/>	<input type="checkbox"/>

(vi) 怎麼找王先生？

A 去他家	B 打電話	C 發電子郵件
<input type="checkbox"/>	<input type="checkbox"/>	<input type="checkbox"/>

(Total for Question 9 = 6 marks)

DO NOT WRITE IN THIS AREA

DO NOT WRITE IN THIS AREA

DO NOT WRITE IN THIS AREA



10 友友



聆聽對話, 用**中文**回答下面的問題。不必用完整的句子。

Listen to the conversation and answer the following questions **in Chinese**. It is not necessary to write full sentences.

(i) 友友來英國幾年了? (1)

(ii) 友友明年打算做什麼? (1)

(iii) 友友想學什麼? (1)



TRADITIONAL/FULL CHARACTERS

(iv) 友友爲什麼喜歡英國的學校? (1)

(v) 友友的愛好是什麼? (寫一個) (1)

(vi) 友友爲什麼不喜歡英國的天氣? (1)

(vii) 來英國的好處是什麼? (1)

(Total for Question 10 = 7 marks)

TOTAL FOR PAPER = 50 MARKS

DO NOT WRITE IN THIS AREA

DO NOT WRITE IN THIS AREA

DO NOT WRITE IN THIS AREA



DO NOT WRITE IN THIS AREA

DO NOT WRITE IN THIS AREA

DO NOT WRITE IN THIS AREA

BLANK PAGE



DO NOT WRITE IN THIS AREA

DO NOT WRITE IN THIS AREA

DO NOT WRITE IN THIS AREA

简体字

SIMPLIFIED CHARACTER VERSION

(Traditional/Full Character Version begins on page 3)



P 4 5 9 4 8 A 0 2 3 4 4

SIMPLIFIED CHARACTERS







Answer ALL questions.

Some questions must be answered with a cross in a box ☒. If you change your mind about an answer, put a line through the box ☒ and then mark your new answer with a cross ☒.

1 爱好

他们有什么爱好？选择正确答案，在三个空格内打 ☒ 号。

Which hobbies do they have? Put a cross ☒ in the **three** correct boxes.

例: 	A 	B 
<input checked="" type="checkbox"/>	<input type="checkbox"/>	<input type="checkbox"/>
C 	D 	E 
<input type="checkbox"/>	<input type="checkbox"/>	<input type="checkbox"/>

(Total for Question 1 = 3 marks)

DO NOT WRITE IN THIS AREA

DO NOT WRITE IN THIS AREA

DO NOT WRITE IN THIS AREA



SIMPLIFIED CHARACTERS

2 去哪里

他们去哪里？选择正确答案，填在空格内。

Where are they going? Write the correct letter in the box.

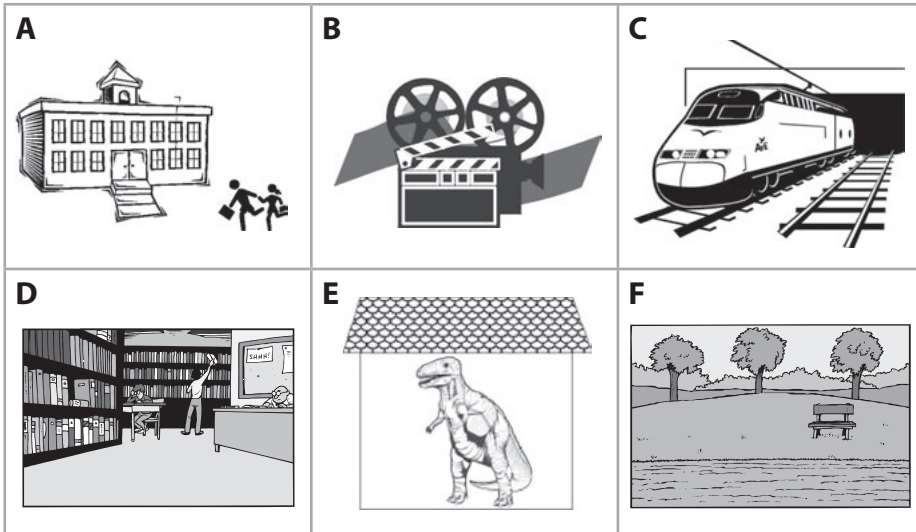

例：马田	A
(i) 海伦	
(ii) 大卫	
(iii) 美美	

(Total for Question 2 = 3 marks)

DO NOT WRITE IN THIS AREA

DO NOT WRITE IN THIS AREA

DO NOT WRITE IN THIS AREA



SIMPLIFIED CHARACTERS

3 朋友

同学们谈他们的朋友。在适当的空格内打☒号。

Classmates are talking about their friends. Put a cross ☒ in the correct box.



	A	B	C	D	E	F	G	H
例: 马田	<input checked="" type="checkbox"/>	<input type="checkbox"/>	<input checked="" type="checkbox"/>	<input type="checkbox"/>	<input type="checkbox"/>	<input type="checkbox"/>	<input type="checkbox"/>	<input type="checkbox"/>
(i) 海伦	<input type="checkbox"/>	<input type="checkbox"/>	<input type="checkbox"/>	<input type="checkbox"/>	<input type="checkbox"/>	<input type="checkbox"/>	<input type="checkbox"/>	<input type="checkbox"/>
(ii) 大卫	<input type="checkbox"/>	<input type="checkbox"/>	<input type="checkbox"/>	<input type="checkbox"/>	<input type="checkbox"/>	<input type="checkbox"/>	<input type="checkbox"/>	<input type="checkbox"/>
(iii) 美美	<input type="checkbox"/>	<input type="checkbox"/>	<input type="checkbox"/>	<input type="checkbox"/>	<input type="checkbox"/>	<input type="checkbox"/>	<input type="checkbox"/>	<input type="checkbox"/>
(iv) 马克	<input type="checkbox"/>	<input type="checkbox"/>	<input type="checkbox"/>	<input type="checkbox"/>	<input type="checkbox"/>	<input type="checkbox"/>	<input type="checkbox"/>	<input type="checkbox"/>
(v) 安娜	<input type="checkbox"/>	<input type="checkbox"/>	<input type="checkbox"/>	<input type="checkbox"/>	<input type="checkbox"/>	<input type="checkbox"/>	<input type="checkbox"/>	<input type="checkbox"/>
(vi) 英华	<input type="checkbox"/>	<input type="checkbox"/>	<input type="checkbox"/>	<input type="checkbox"/>	<input type="checkbox"/>	<input type="checkbox"/>	<input type="checkbox"/>	<input type="checkbox"/>

(Total for Question 3 = 6 marks)

DO NOT WRITE IN THIS AREA

DO NOT WRITE IN THIS AREA

DO NOT WRITE IN THIS AREA



DO NOT WRITE IN THIS AREA

DO NOT WRITE IN THIS AREA

DO NOT WRITE IN THIS AREA

BLANK PAGE



SIMPLIFIED CHARACTERS

4 学习生活

大卫是我的朋友。在适当的空格内打☒号。

David is my friend. Put a cross☒ in the correct box.

例: 大卫今年多大?

A	B	C
18	19	20
<input type="checkbox"/>	<input checked="" type="checkbox"/>	<input type="checkbox"/>



(i) 他学习什么?

A	B	C
		
<input type="checkbox"/>	<input type="checkbox"/>	<input type="checkbox"/>

(ii) 他什么时候起床?

A	B	C
8:00	8:15	8:30
<input type="checkbox"/>	<input type="checkbox"/>	<input type="checkbox"/>

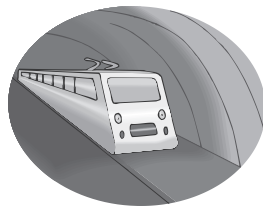
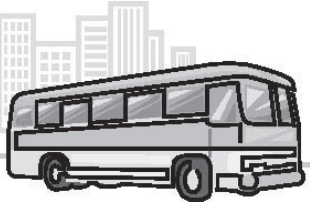
(iii) 他怎么去学校?

A	B	C
		
<input type="checkbox"/>	<input type="checkbox"/>	<input type="checkbox"/>

DO NOT WRITE IN THIS AREA



DO NOT WRITE IN THIS AREA

DO NOT WRITE IN THIS AREA



SIMPLIFIED CHARACTERS

(iv) 他将来要做什么工作?

<p>A</p> 	<p>B</p> 	<p>C</p> 
<input type="checkbox"/>	<input type="checkbox"/>	<input type="checkbox"/>

(v) 他的哥哥在哪里?

<p>A</p> <p>中国</p>	<p>B</p> <p>美国</p>	<p>C</p> <p>日本</p>
<input type="checkbox"/>	<input type="checkbox"/>	<input type="checkbox"/>

(vi) 大卫什么时候去旅行?

<p>A</p> <p>四月</p>	<p>B</p> <p>十月</p>	<p>C</p> <p>十二月</p>
<input type="checkbox"/>	<input type="checkbox"/>	<input type="checkbox"/>

(Total for Question 4 = 6 marks)

DO NOT WRITE IN THIS AREA

DO NOT WRITE IN THIS AREA

DO NOT WRITE IN THIS AREA





SIMPLIFIED CHARACTERS

5 酒店

聆听对话。在适当的空格内打☒号。

Listen to the conversation. Put a cross ☒ in the correct box.



例: 她在哪里?

<p>A</p> 	<p>B</p> 	<p>C</p> 
<p style="text-align: center;">☒</p>	<p style="text-align: center;">☒</p>	<p style="text-align: center;">☒</p>

(i) 她要住几天?

<p>A</p> <p style="text-align: center;">1</p>	<p>B</p> <p style="text-align: center;">3</p>	<p>C</p> <p style="text-align: center;">6</p>
<p style="text-align: center;">☒</p>	<p style="text-align: center;">☒</p>	<p style="text-align: center;">☒</p>

(ii) 她要给服务员看什么?

<p>A</p> 	<p>B</p> 	<p>C</p> 
<p style="text-align: center;">☒</p>	<p style="text-align: center;">☒</p>	<p style="text-align: center;">☒</p>



(iii) 早餐几点结束?

<p>A</p> <p style="text-align: center;">6:00</p>	<p>B</p> <p style="text-align: center;">7:30</p>	<p>C</p> <p style="text-align: center;">9:00</p>
<p style="text-align: center;">☒</p>	<p style="text-align: center;">☒</p>	<p style="text-align: center;">☒</p>



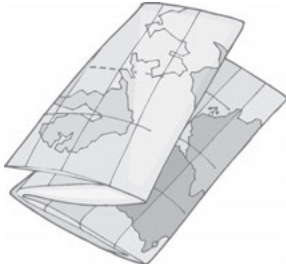

SIMPLIFIED CHARACTERS

(iv) 她想要什么?

<p>A</p> 	<p>B</p> 	<p>C</p> 
<input type="checkbox"/>	<input type="checkbox"/>	<input type="checkbox"/>

(v) 她要去哪里?

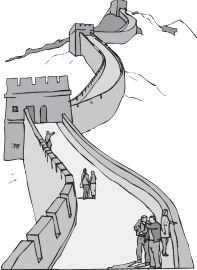
<p>A</p> 	<p>B</p> 	<p>C</p> 
<input type="checkbox"/>	<input type="checkbox"/>	<input type="checkbox"/>

(vi) 要多少钱?

<p>A</p> <p>三十块</p>	<p>B</p> <p>五十块</p>	<p>C</p> <p>九十块</p>
<input type="checkbox"/>	<input type="checkbox"/>	<input type="checkbox"/>

(Total for Question 5 = 6 marks)

DO NOT WRITE IN THIS AREA

DO NOT WRITE IN THIS AREA

DO NOT WRITE IN THIS AREA



SIMPLIFIED CHARACTERS

6 放学以后

同学们谈他们今天放学以后做什么。在适当的空格内打☒号。

Classmates are talking about what they will do today after school. Put a cross ☒ in the correct box.

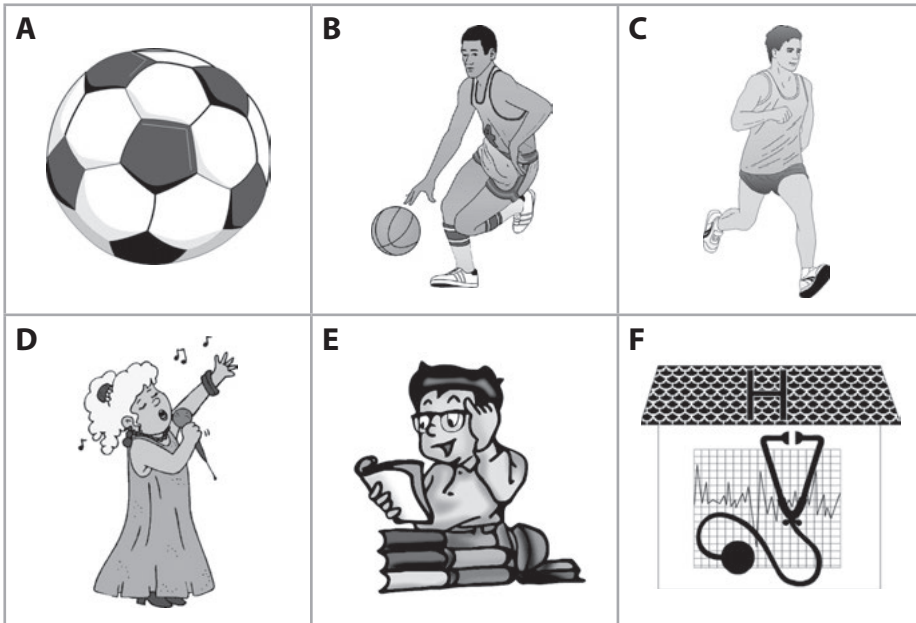

	A	B	C	D	E	F
例: 马田	<input type="checkbox"/>	<input checked="" type="checkbox"/>	<input type="checkbox"/>	<input type="checkbox"/>	<input type="checkbox"/>	<input type="checkbox"/>
(i) 海伦	<input type="checkbox"/>	<input type="checkbox"/>	<input type="checkbox"/>	<input type="checkbox"/>	<input type="checkbox"/>	<input type="checkbox"/>
(ii) 大卫	<input type="checkbox"/>	<input type="checkbox"/>	<input type="checkbox"/>	<input type="checkbox"/>	<input type="checkbox"/>	<input type="checkbox"/>
(iii) 美美	<input type="checkbox"/>	<input type="checkbox"/>	<input type="checkbox"/>	<input type="checkbox"/>	<input type="checkbox"/>	<input type="checkbox"/>
(iv) 马克	<input type="checkbox"/>	<input type="checkbox"/>	<input type="checkbox"/>	<input type="checkbox"/>	<input type="checkbox"/>	<input type="checkbox"/>

(Total for Question 6 = 4 marks)

DO NOT WRITE IN THIS AREA

DO NOT WRITE IN THIS AREA

DO NOT WRITE IN THIS AREA



DO NOT WRITE IN THIS AREA

DO NOT WRITE IN THIS AREA

DO NOT WRITE IN THIS AREA

BLANK PAGE



P 4 5 9 4 8 A 0 3 3 4 4



SIMPLIFIED CHARACTERS

7 东西不见了



东东很不高兴。在适当的空格内打☒号。

Dongdong is unhappy. Put a cross ☒ in the correct box.

例: 东东怎么了?

<p>A</p> 	<p>B</p> 	<p>C</p> 
<input type="checkbox"/>	<input checked="" type="checkbox"/>	<input type="checkbox"/>

(i) 什么不见了?

<p>A</p> 	<p>B</p> 	<p>C</p> 
<input type="checkbox"/>	<input checked="" type="checkbox"/>	<input type="checkbox"/>

(ii) 他几点回家?

<p>A</p> <p>三点</p>	<p>B</p> <p>七点</p>	<p>C</p> <p>八点</p>
<input type="checkbox"/>	<input checked="" type="checkbox"/>	<input type="checkbox"/>



SIMPLIFIED CHARACTERS

(iii) 谁会生气?

A 妈妈	B 同学	C 爸爸
<input type="checkbox"/>	<input type="checkbox"/>	<input type="checkbox"/>

(Total for Question 7 = 3 marks)

DO NOT WRITE IN THIS AREA

DO NOT WRITE IN THIS AREA

DO NOT WRITE IN THIS AREA







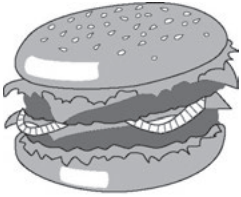

SIMPLIFIED CHARACTERS

8 中国餐厅

同学们在中国餐厅点菜。在适当的空格内打☒号。

Classmates are ordering food in a Chinese restaurant. Put a cross ☒ in the correct box.

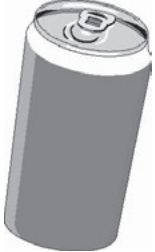
<p>A</p> 	<p>B</p> 	<p>C</p> 	<p>D</p> 
<p>E</p> 	<p>F</p>  <p>© Image navi - Sozajiten / Alamy Stock Photo</p>	<p>G</p> 	<p>H</p> 

	A	B	C	D	E	F	G	H
例: 马田	<input checked="" type="checkbox"/>	<input type="checkbox"/>	<input type="checkbox"/>	<input type="checkbox"/>	<input type="checkbox"/>	<input type="checkbox"/>	<input type="checkbox"/>	<input type="checkbox"/>
(i) 安娜	<input type="checkbox"/>	<input type="checkbox"/>	<input type="checkbox"/>	<input type="checkbox"/>	<input type="checkbox"/>	<input type="checkbox"/>	<input type="checkbox"/>	<input type="checkbox"/>
(ii) 大卫	<input type="checkbox"/>	<input type="checkbox"/>	<input type="checkbox"/>	<input type="checkbox"/>	<input type="checkbox"/>	<input type="checkbox"/>	<input type="checkbox"/>	<input type="checkbox"/>
(iii) 海伦	<input type="checkbox"/>	<input type="checkbox"/>	<input type="checkbox"/>	<input type="checkbox"/>	<input type="checkbox"/>	<input type="checkbox"/>	<input type="checkbox"/>	<input type="checkbox"/>
(iv) 马克	<input type="checkbox"/>	<input type="checkbox"/>	<input type="checkbox"/>	<input type="checkbox"/>	<input type="checkbox"/>	<input type="checkbox"/>	<input type="checkbox"/>	<input type="checkbox"/>
(v) 美美	<input type="checkbox"/>	<input type="checkbox"/>	<input type="checkbox"/>	<input type="checkbox"/>	<input type="checkbox"/>	<input type="checkbox"/>	<input type="checkbox"/>	<input type="checkbox"/>
(vi) 英华	<input type="checkbox"/>	<input type="checkbox"/>	<input type="checkbox"/>	<input type="checkbox"/>	<input type="checkbox"/>	<input type="checkbox"/>	<input type="checkbox"/>	<input type="checkbox"/>

(Total for Question 8 = 6 marks)

DO NOT WRITE IN THIS AREA

DO NOT WRITE IN THIS AREA

DO NOT WRITE IN THIS AREA



DO NOT WRITE IN THIS AREA

DO NOT WRITE IN THIS AREA

DO NOT WRITE IN THIS AREA

BLANK PAGE



SIMPLIFIED CHARACTERS

9 暑期工作

老师和学生在说话。在适当的空格内打☒号。

A teacher and her student are talking. Put a cross ☒ in the correct box.

例: 学校什么时候放假?

A 明天	B 星期一	C 下个星期六
☒	☒	☒

(i) 他想买什么?

A 自行车	B 电脑	C 电子游戏
☒	☒	☒

(ii) 他喜欢什么?

A 动物	B 书	C 鞋
☒	☒	☒

(iii) 他可以教什么?

A 中文	B 数学	C 化学
☒	☒	☒

DO NOT WRITE IN THIS AREA

DO NOT WRITE IN THIS AREA

DO NOT WRITE IN THIS AREA



SIMPLIFIED CHARACTERS

(iv) 他什么时候工作?

A 星期一和星期四	B 星期二和星期三	C 星期二和星期五
<input type="checkbox"/>	<input type="checkbox"/>	<input type="checkbox"/>

(v) 每次多少钱?

A 五镑	B 七镑	C 十镑
<input type="checkbox"/>	<input type="checkbox"/>	<input type="checkbox"/>

(vi) 怎么找王先生?

A 去他家	B 打电话	C 发电子邮件
<input type="checkbox"/>	<input type="checkbox"/>	<input type="checkbox"/>

(Total for Question 9 = 6 marks)

DO NOT WRITE IN THIS AREA

DO NOT WRITE IN THIS AREA

DO NOT WRITE IN THIS AREA



SIMPLIFIED CHARACTERS

10 友友



聆听对话, 用**中文**回答下面的问题。不必用完整的句子。

Listen to the conversation and answer the following questions **in Chinese**. It is not necessary to write full sentences.

(i) 友友来英国几年了? (1)

(ii) 友友明年打算做什么? (1)

(iii) 友友想学什么? (1)

DO NOT WRITE IN THIS AREA

DO NOT WRITE IN THIS AREA

DO NOT WRITE IN THIS AREA



SIMPLIFIED CHARACTERS

(iv) 友友为什么喜欢英国的学校? (1)

(v) 友友的爱好是什么? (写一个) (1)

(vi) 友友为什么不喜欢英国的天气? (1)

(vii) 来英国的好处是什么? (1)

(Total for Question 10 = 7 marks)

TOTAL FOR PAPER = 50 MARKS

DO NOT WRITE IN THIS AREA

DO NOT WRITE IN THIS AREA

DO NOT WRITE IN THIS AREA



DO NOT WRITE IN THIS AREA

DO NOT WRITE IN THIS AREA

DO NOT WRITE IN THIS AREA

BLANK PAGE



DO NOT WRITE IN THIS AREA

DO NOT WRITE IN THIS AREA

DO NOT WRITE IN THIS AREA

BLANK PAGE



DO NOT WRITE IN THIS AREA

DO NOT WRITE IN THIS AREA

DO NOT WRITE IN THIS AREA

Acknowledgements

Images used within this paper may be from www.clipart.com.

