



UNIVERSITY OF CAMBRIDGE INTERNATIONAL EXAMINATIONS
International General Certificate of Secondary Education

www.XtremePapers.com

BIOLOGY

0610/12

Paper 1 Multiple Choice

October/November 2011

45 minutes

Additional Materials: Multiple Choice Answer Sheet
Soft clean eraser
Soft pencil (type B or HB is recommended)

* 9 5 2 5 5 4 2 6 0 8 *

READ THESE INSTRUCTIONS FIRST

Write in soft pencil.

Do not use staples, paper clips, highlighters, glue or correction fluid.

Write your name, Centre number and candidate number on the Answer Sheet in the spaces provided unless this has been done for you.

There are **forty** questions on this paper. Answer **all** questions. For each question there are four possible answers **A, B, C** and **D**.

Choose the **one** you consider correct and record your choice in **soft pencil** on the separate Answer Sheet.

Read the instructions on the Answer Sheet very carefully.

Each correct answer will score one mark. A mark will not be deducted for a wrong answer.
Any rough working should be done in this booklet.

This document consists of **16** printed pages.



1 Root hair cells are found on plant roots.

Which feature would be present in a root hair cell but **not** a sperm cell?

- A cell membrane
- B cell wall
- C chloroplasts
- D cytoplasm

2 Which cell shows the position of the nucleus correctly?

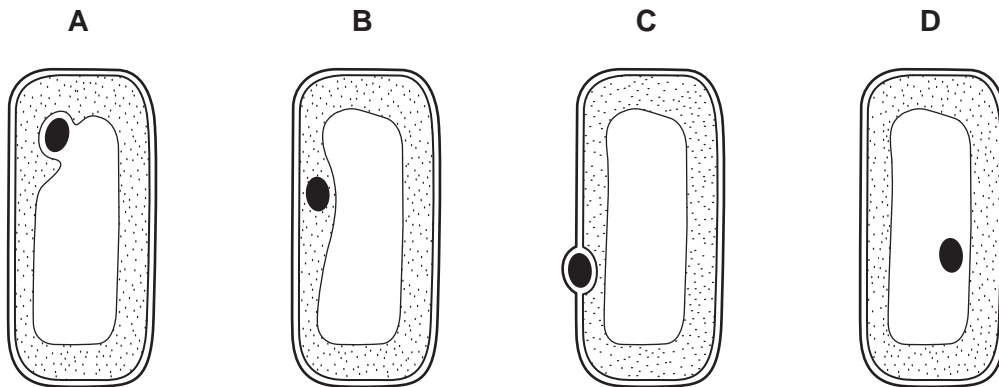

3 What is the correct order of arthropod groups, from those with most legs to those with fewest legs?

- A arachnids → crustaceans → insects → myriapods
- B crustaceans → myriapods → insects → arachnids
- C insects → arachnids → myriapods → crustaceans
- D myriapods → crustaceans → arachnids → insects

4 Which animal is an annelid?

- 1 has legs go to 2
- has no legs go to 3
- 2 has six legs organism **A**
- has eight legs organism **B**
- 3 has a shell organism **C**
- has no shell organism **D**

5 What are the levels of organisation of

- the wall of a villus,
- the small intestine?

	wall of a villus	small intestine
A	cell	organ
B	cell	organ system
C	tissue	organ
D	tissue	organ system

6 Which characteristic of living organisms is described by the following definition?

'The ability to detect changes in the environment and make responses'.

- A** excretion
- B** movement
- C** respiration
- D** sensitivity

7 Phloem is an example of

- A** a cell.
- B** a tissue.
- C** an organ.
- D** an organ system.

8 Which structure is found in a palisade cell but **not** in a liver cell?

- A** cell membrane
- B** central vacuole
- C** cytoplasm
- D** nucleus

9 Which is an incisor tooth?

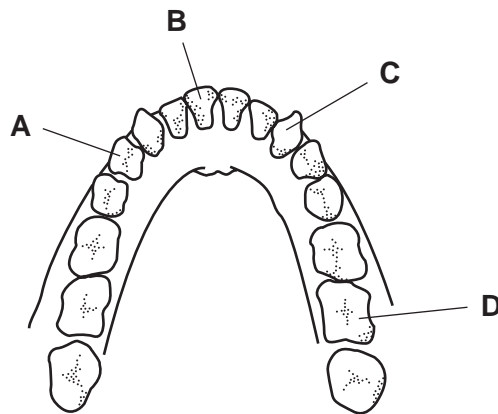

10 A human digestive enzyme breaks down its substrate at a fast rate at 35 °C.

What would occur if the enzyme and substrate were kept at 75 °C?

- A The enzyme would stop working and be denatured.
 - B The reaction would continue at the same rate.
 - C The reaction would take place more quickly.
 - D The reaction would take place more slowly.
- 11 The diagram shows a fetus attached by the placenta to the uterus wall of the mother.

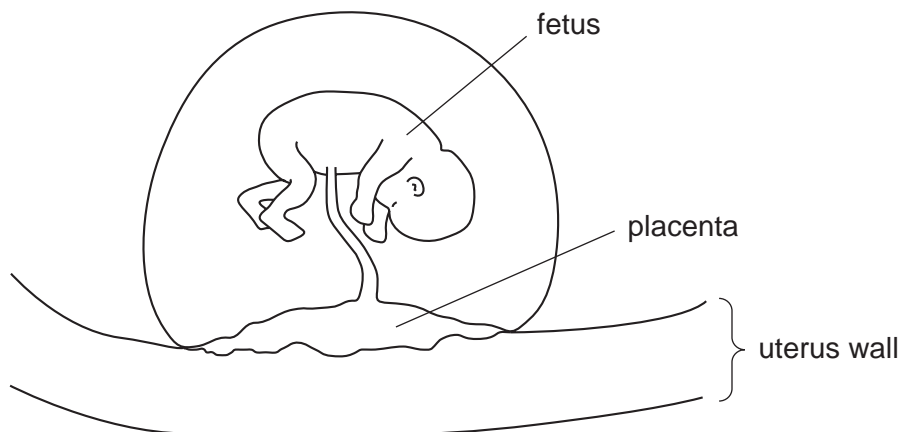

By which process do all substances pass between the fetus and the mother in the placenta?

- A diffusion
- B nutrition
- C osmosis
- D respiration

12 Dietary fibre passes through several structures after leaving the stomach.

In which order does the dietary fibre pass through these structures?

- A duodenum → ileum → colon → rectum
- B duodenum → ileum → rectum → colon
- C ileum → duodenum → colon → rectum
- D ileum → duodenum → rectum → colon

13 What happens in osmosis?

- A movement of solute molecules against their concentration gradient
- B movement of solute molecules down their concentration gradient
- C movement of water molecules against their concentration gradient
- D movement of water molecules down their concentration gradient

14 The roots of plants take up nitrates from the soil.

What are the nitrates used to make?

- A fat
- B glucose
- C protein
- D starch

15 The diagram shows the action of amylase.

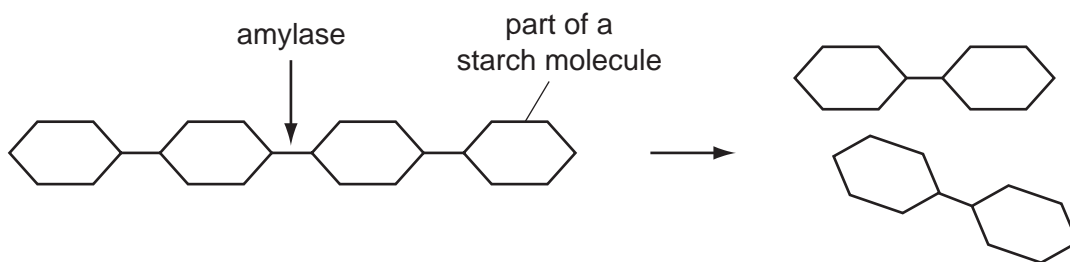

What is the function of the enzyme amylase?

- A breaks down the substrate into amino acids
- B changes the product into the substrate
- C increases the rate of starch breaking down into glucose
- D increases the rate of starch breaking down into maltose

16 Small molecules are used as the basic units in the synthesis of large food molecules.

Which statement is correct?

- A Amino acids are basic units of carbohydrates.
- B Fatty acids are basic units of glycogen.
- C Glycerol is a basic unit of oils.
- D Simple sugar is a basic unit of protein.

17 The diagram shows a germinated bean seed with a horizontal radicle. This is placed on a slowly rotating disc and is left for three days.

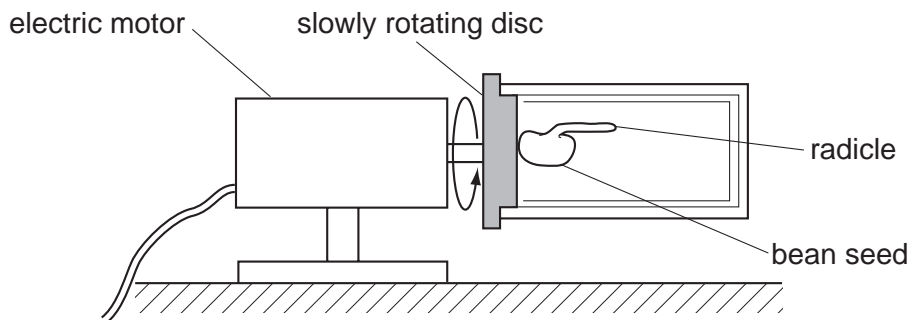

Which diagram shows the appearance of the radicle after three days?

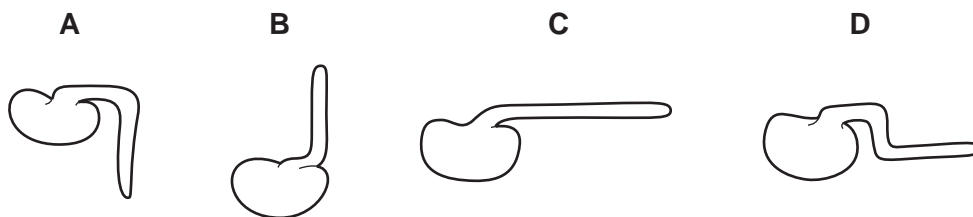

18 Which process does **not** release carbon dioxide to the atmosphere?

- A decomposition of animals
- B photosynthesis of plants
- C respiration of animals
- D respiration of plants

19 In what form does a plant absorb and lose water?

	absorbs	loses
A	liquid	liquid
B	liquid	vapour
C	vapour	liquid
D	vapour	vapour

20 The graph shows the variation in a person's body temperature over a period of time.

Which temperature change is likely to cause most sweating?

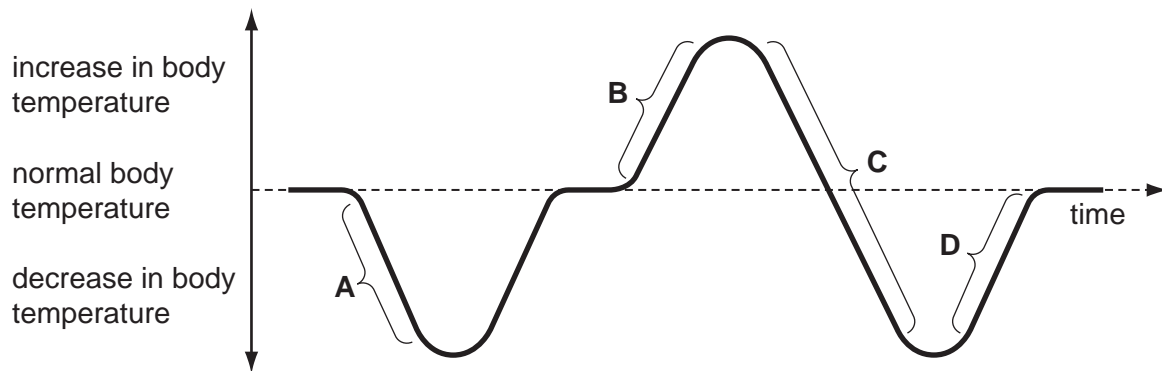

21 An experiment is set up to investigate the uptake of oxygen by germinating seeds.

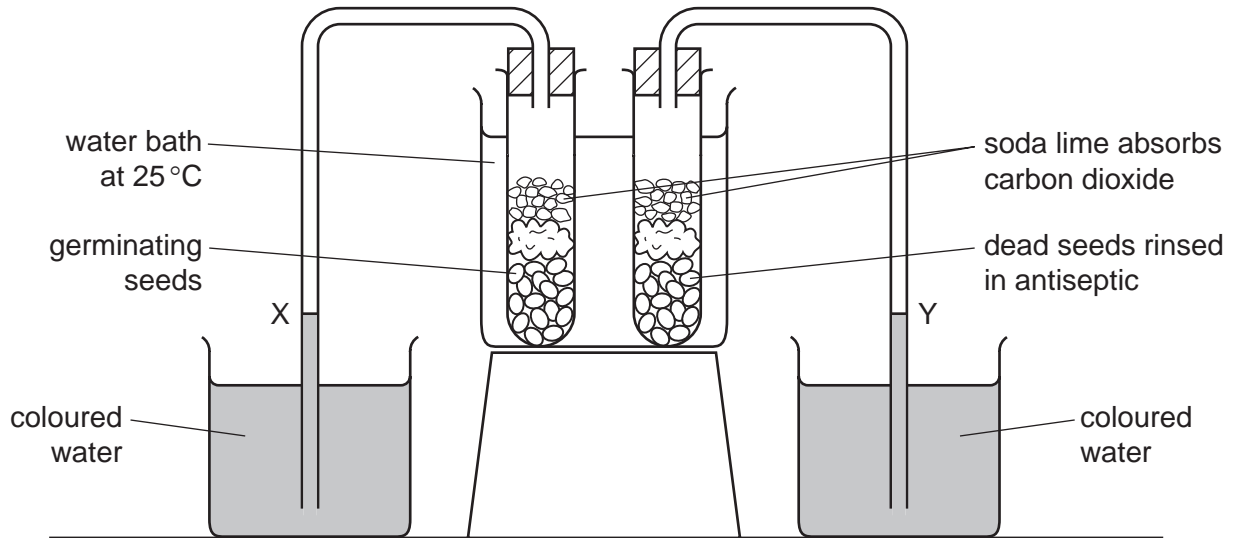

What happens to the levels at X and Y?

	X	Y
A	falls	rises
B	falls	unchanged
C	rises	falls
D	rises	unchanged

22 Which type of cells do **all** sense organs contain?

- A** ciliated
- B** effector
- C** mesophyll
- D** receptor

23 Which materials are excreted by kidneys and lungs?

	kidneys	lungs
A	carbon dioxide	carbon dioxide
B	carbon dioxide	urea
C	urea	carbon dioxide
D	urea	urea

24 The diagram shows a plant shoot and the same shoot six hours later.

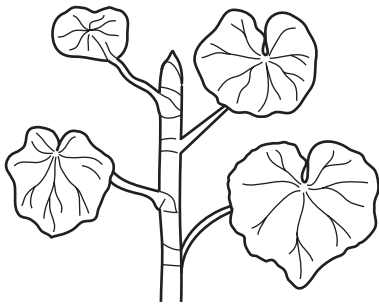

plant shoot

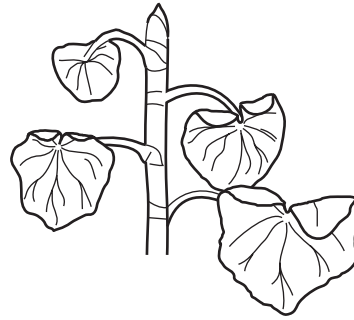

same shoot six hours later

Which change in environmental conditions could cause this change in the appearance of the shoot?

- A a decrease in available water
 - B a decrease in light intensity
 - C a decrease in wind speed
 - D an increase in humidity
- 25 Which group contains substances that are **all** carried in the blood?
- A amino acids, carbon dioxide and cellulose
 - B glucose, glycogen and lactic acid
 - C oestrogen, oxygen and starch
 - D salts, testosterone and urea

- 26 The diagram shows a potato tuber that developed from the stem of a parent potato plant. Three shoots are starting to grow from the tuber.

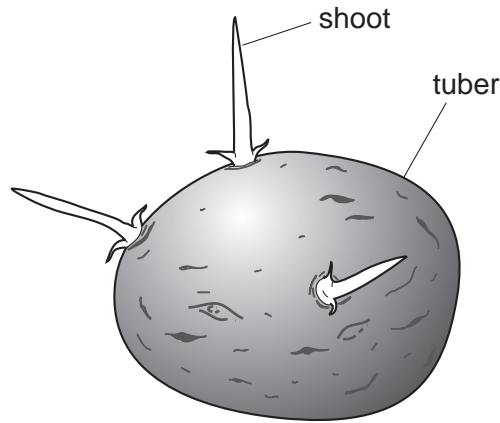

How do the genotypes of the shoots compare with the genotypes of the tuber and of the parent?

- A They are all different.
 - B They are all identical.
 - C The shoots are identical to each other, but are different from the tuber and the parent.
 - D The shoots are identical to the tuber, but are different from the parent.
- 27 What are the chromosomes for the two sexes in human beings?

	female	male
A	XX	XY
B	XX	YY
C	XY	XX
D	YY	XY

- 28 The diagram shows a neurone.

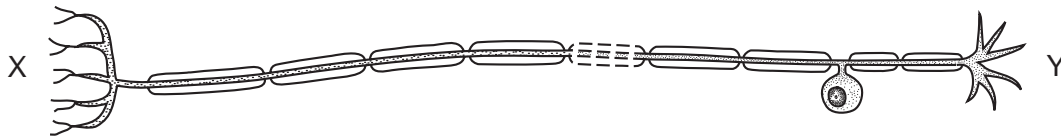

Which structures could be found at X and Y?

	X	Y
A	brain	intestine
B	brain	leg
C	eye	hand
D	skin	spinal cord

29 Which is **not** growth of an organism?

- A increase in dry mass
- B increase in the number of cells
- C permanent increase in size
- D swelling by absorbing water

30 The diagram shows the early growth of a green plant.

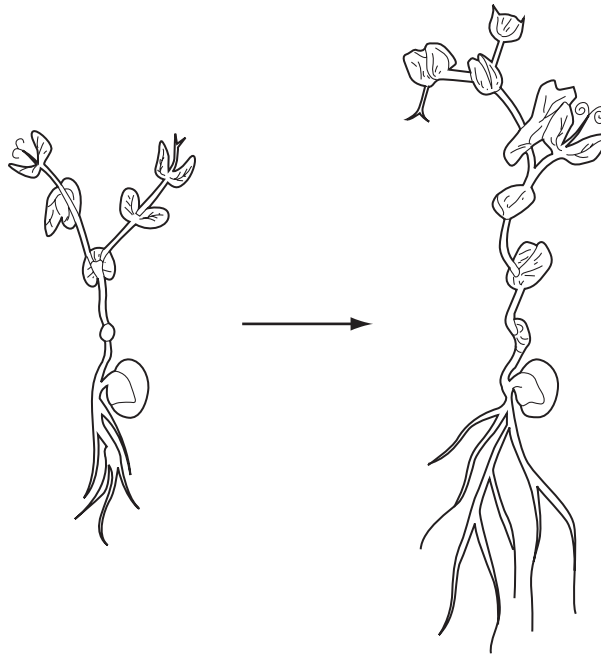

What is occurring?

	mitosis	development
A	✓	✓
B	✓	x
C	x	✓
D	x	x

key

✓ = occurs

x = does not occur

31 The colour of a mouse's fur is controlled by a single pair of alleles.

A mouse with black fur was crossed with a mouse with white fur. All the offspring had black fur.

What would be the most likely ratio in several litters of offspring if two of these black offspring were crossed?

	black fur	white fur
A	1	3
B	2	2
C	3	1
D	4	0

32 The diagram shows the male reproductive system.

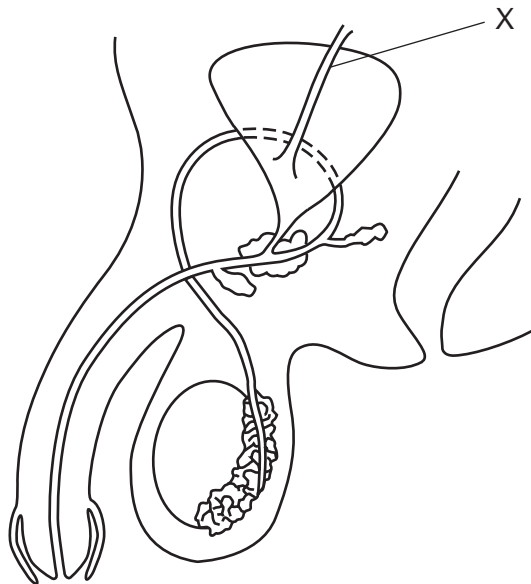

What is the tube labelled X?

- A** rectum
- B** sperm duct (vas deferens)
- C** ureter
- D** urethra

33 The diagram gives a simplified scheme for energy flow through an ecosystem.

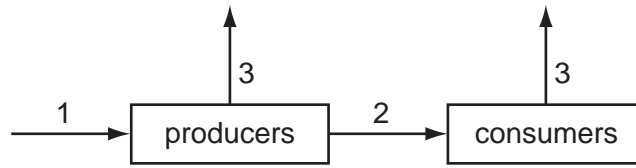

Which processes do the labelled arrows represent?

	1	2	3
A	feeding	photosynthesis	respiration
B	feeding	respiration	photosynthesis
C	photosynthesis	feeding	respiration
D	photosynthesis	respiration	feeding

34 The diagram shows part of the carbon cycle.

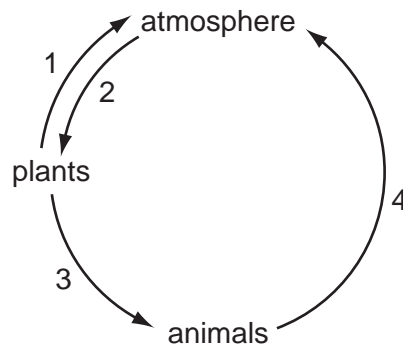

Which numbers represent excretion?

- A** 1 and 2 **B** 1 and 4 **C** 2 and 3 **D** 3 and 4

35 The diagram shows a food web.

At which level does energy from the Sun enter the food web?

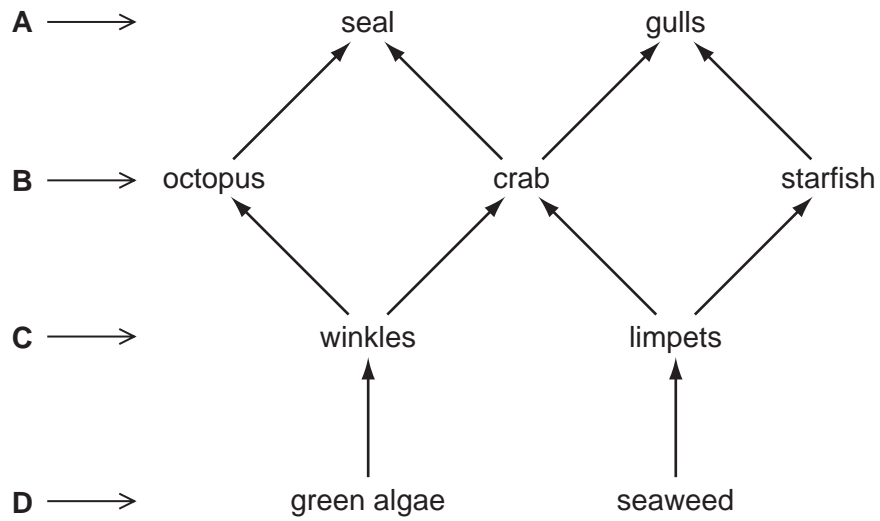

36 The graph shows the rate of growth for a population of herbivores.

Which is the exponential (log) phase in the growth of this population?

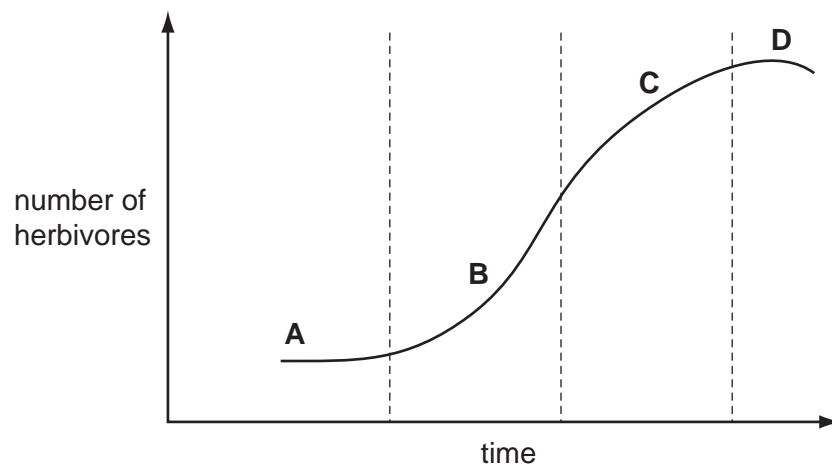

- 37 Different pesticides were tested to see how poisonous they were to fish. Scientists found the concentration of pesticide that killed 50% of the fish within four days.

The table shows the results of the tests.

pesticide	concentration that killed 50% of the fish / p.p.m.
DDT	0.03
dieldrin	0.01
malathion	12.20
parathion	2.11

Which pesticide was the most dangerous to the fish?

- A DDT
- B dieldrin
- C malathion
- D parathion

- 38 The diagram shows the carbon cycle.

Which process produces carbon dioxide from substances made by photosynthesis millions of years ago?

