



UNIVERSITY OF CAMBRIDGE INTERNATIONAL EXAMINATIONS  
International General Certificate of Secondary Education

CANDIDATE  
NAME

CENTRE  
NUMBER

--	--	--	--	--

CANDIDATE  
NUMBER

--	--	--	--



**BIOLOGY**

**0610/32**

Paper 3 Extended

**October/November 2009**

**1 hour 15 minutes**

Candidates answer on the Question Paper.

No Additional Materials are required.

**READ THESE INSTRUCTIONS FIRST**

Write your Centre number, candidate number and name on all the work you hand in.

Write in dark blue or black pen.

You may use a pencil for any diagrams or graphs.

Do not use staples, paper clips, highlighters, glue or correction fluid.

**DO NOT WRITE IN ANY BARCODES.**

Answer **all** questions.

At the end of the examination, fasten all your work securely together.

The number of marks is given in brackets [ ] at the end of each question or part question.

For Examiner's Use	
<b>1</b>	
<b>2</b>	
<b>3</b>	
<b>4</b>	
<b>5</b>	
<b>6</b>	
<b>Total</b>	

This document consists of **16** printed pages and **4** blank pages.



1 Fig. 1.1 shows a bacterium, a virus and a fungus.

For  
Examiner's  
Use

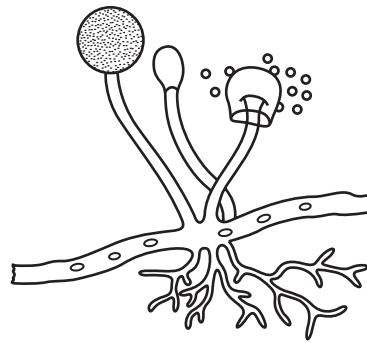
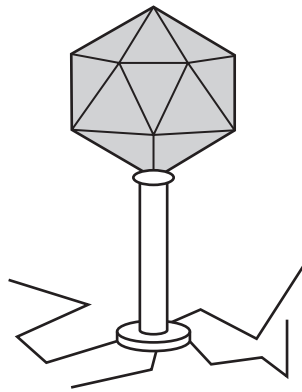
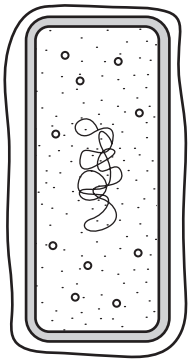

not to scale

Fig. 1.1

(a) Complete the table to compare the three organisms shown in Fig. 1.1 by using a tick (✓) to indicate if the organism shows the feature, or a cross (X) if it does not. The first row has been completed for you.

feature	bacterium	virus	fungus
produces spores	X	X	✓
hyphae			
capsule			
nucleus			

[3]

(b) Explain how the fungus shown in Fig. 1.1 is adapted to obtain its food.

.....

.....

.....

.....

.....

.....

.....

[3]

(c) Explain how the fungus spreads to new sources of food.

.....

.....

.....

..... [2]

[Total: 8]

*For  
Examiner's  
Use*

2 Fig. 2.1 shows a villus from the small intestine of a mammal and an enlarged view of a cell from region **A**.

For  
Examiner's  
Use

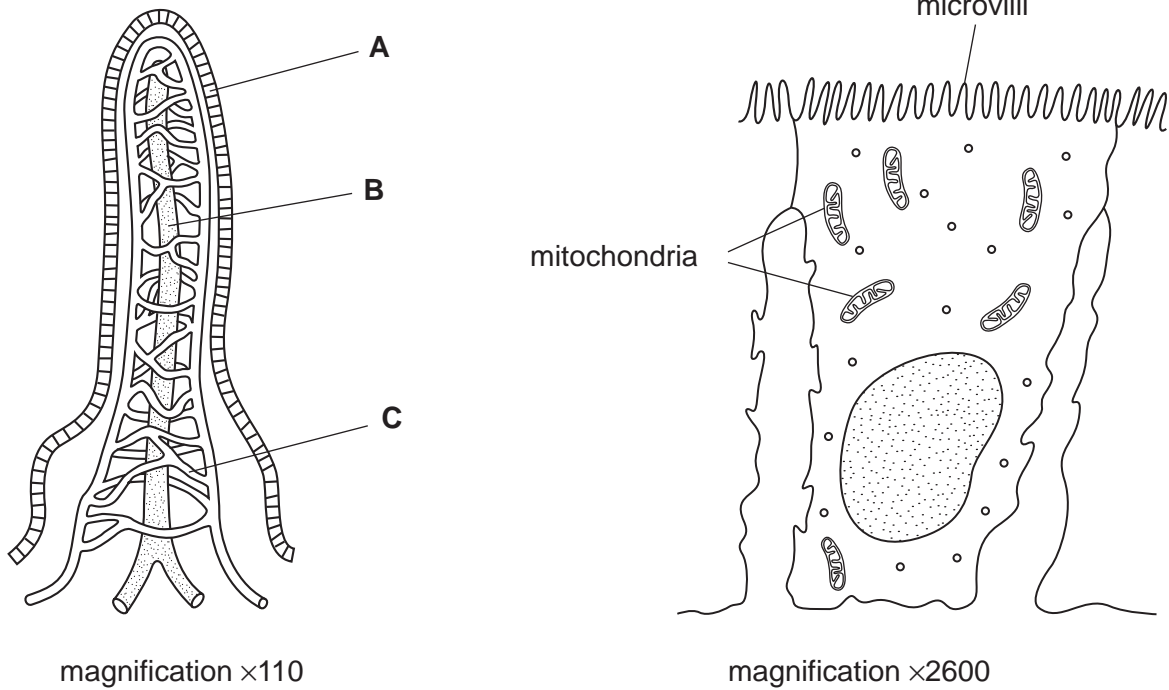

Fig. 2.1

(a) Name regions **A**, **B** and **C**.

**A** .....

**B** .....

**C** ..... [3]

(b) Explain why the cells from region **A** have many microvilli and mitochondria.

*many microvilli* .....

.....

.....

*many mitochondria* .....

.....

..... [4]

(c) The Food Standards Agency in the UK defines a food additive as:

‘any substance intentionally added to food for a specific function that is not normally eaten as a food or used as a characteristic ingredient in food.’

Some additives are naturally occurring substances, but others are man-made. Some additives have been identified as a risk to people’s health.

(i) State two benefits of using food additives in processed foods.

- 1. ....  
.....
  - 2. ....  
.....
- [2]

(ii) State **four** possible risks to health that have been linked to food additives.

- .....
  - .....
  - .....
  - .....
  - .....
  - .....
  - .....
- [4]

[Total: 13]

For  
Examiner's  
Use

3 A student set up the apparatus shown in Fig. 3.1 to investigate the effect of carbon dioxide concentration on the rate of photosynthesis of a pond plant.

The student used five similar pieces of pond plant and five different concentrations of sodium hydrogen carbonate ( $\text{NaHCO}_3$ ) solution, which provides the carbon dioxide.

The student counted the number of bubbles produced by the pond plant over a period of five minutes.

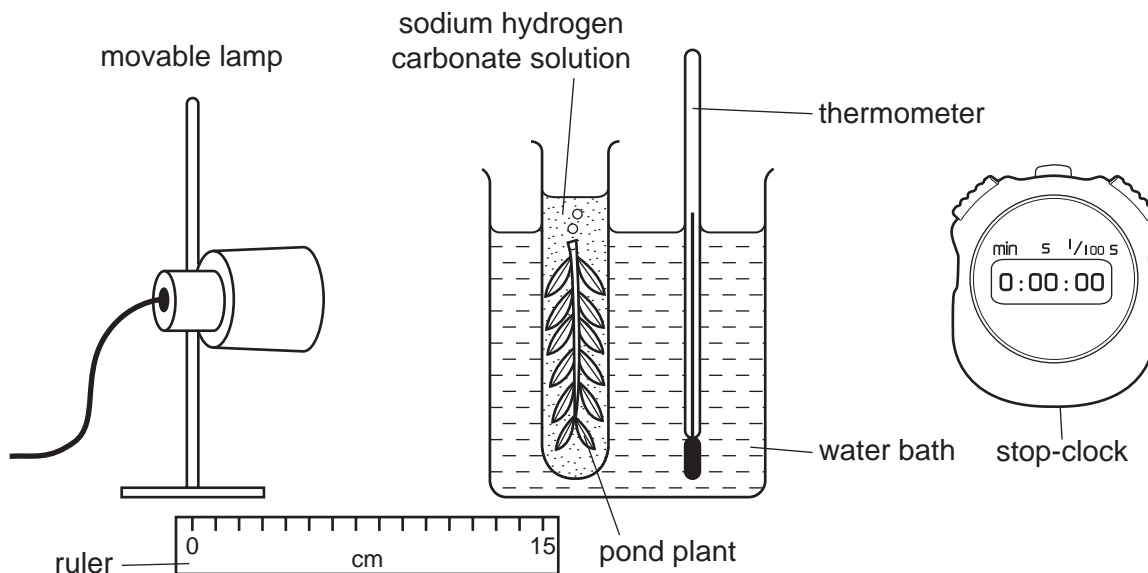

Fig. 3.1

(a) Explain how the student made sure that the results were due **only** to the change in carbon dioxide concentration.

.....

.....

.....

.....

.....

.....

.....

.....

.....

.....

.....

.....

[4]

The student repeated the investigation at each concentration and calculated the rate of photosynthesis.

For  
Examiner's  
Use

The student's results are shown in Table 3.1.

**Table 3.1**

carbon dioxide concentration / %	rate of photosynthesis / number of bubbles per minute			
	1st	2nd	3rd	mean
0	3	2	4	3
0.1	6	4	5	5
0.2	12	7	11	
0.3	14	15	16	15
0.4	18	22	21	20
0.5	19	23	21	21

- (b) (i) Calculate the mean rate of photosynthesis when the carbon dioxide concentration was 0.2% and write your answer in the table. [1]
- (ii) Plot the results from Table 3.1 on the axes below. Draw an appropriate line on the graph to show the relationship between carbon dioxide concentration and the rate of photosynthesis. [2]

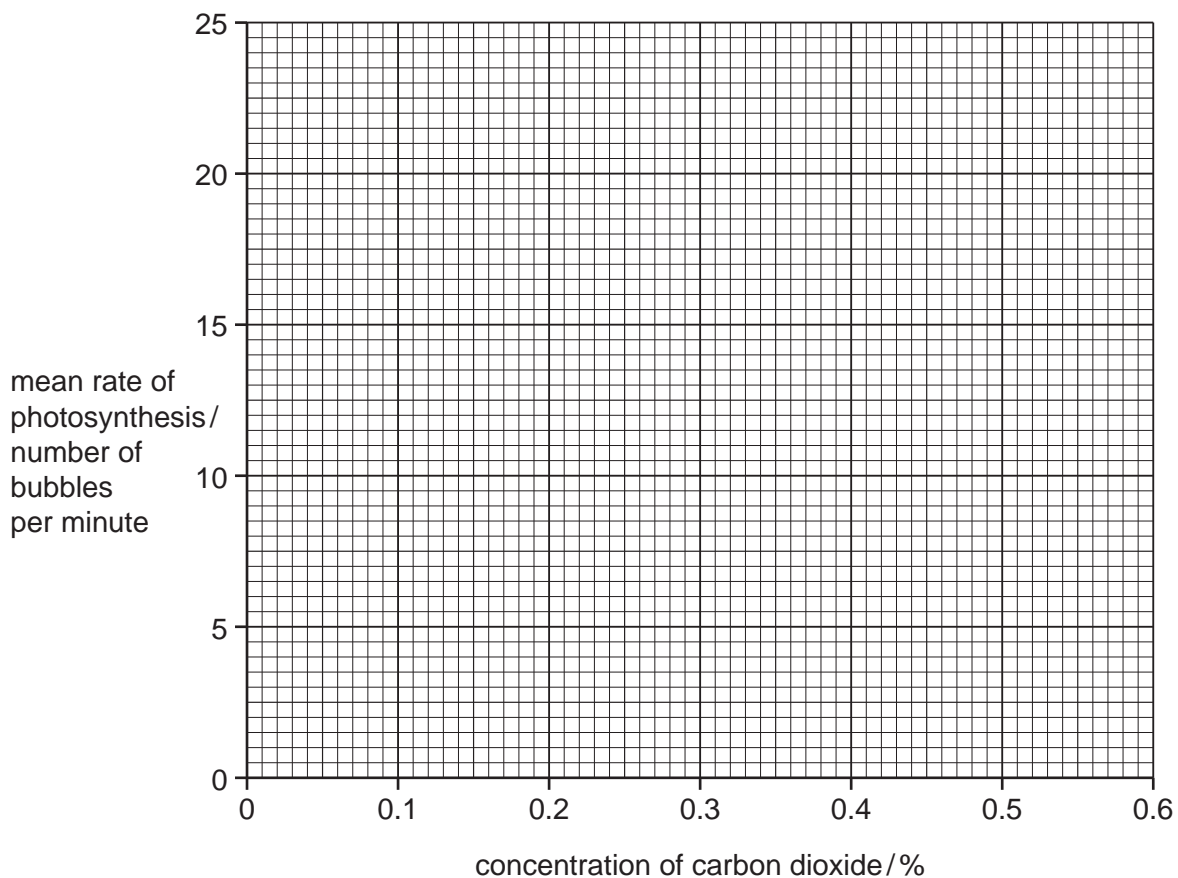

**Fig. 3.2**

(c) Explain the effect of increasing carbon dioxide concentration on the rate of photosynthesis up to 0.4% as shown in your graph.

.....  
.....  
.....  
.....  
..... [2]

(d) Suggest the result that the student would get if a carbon dioxide concentration of 0.6% was used and explain your answer.

*result* ..... bubbles per minute  
*explanation* .....  
.....  
..... [3]

(e) The student used tap water as the 0% carbon dioxide concentration.

Explain why the student recorded some bubbles being produced.  
.....  
..... [1]

[Total: 13]



**BLANK PAGE**

**QUESTION 4 STARTS ON THE NEXT PAGE.**

4 Fig. 4.1 shows a kidney tubule and its associated blood vessels.

For  
Examiner's  
Use

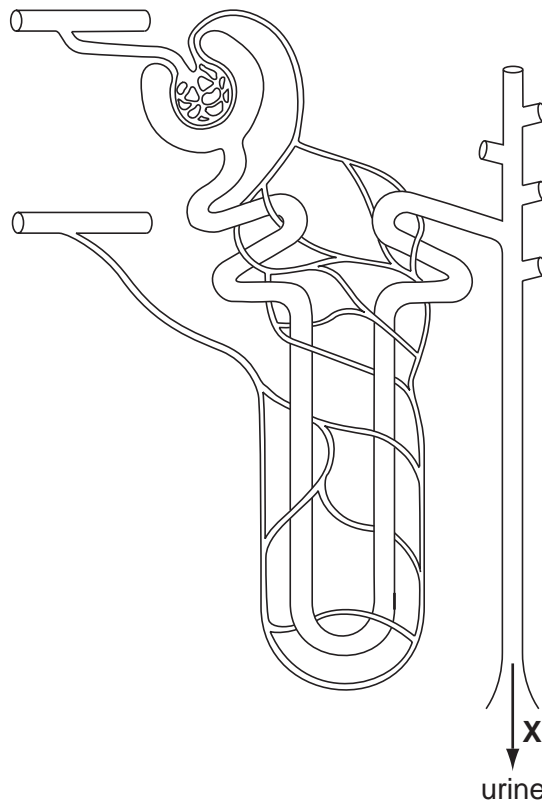

Fig. 4.1

(a) Use label lines and the letters **P**, **Q** and **R** to identify the areas in the tubule shown in Fig. 4.1.

**P** where blood is filtered,

**Q** where glucose is reabsorbed,

**R** where the concentration of urine may be increased by the reabsorption of water. [3]

(b) Water is reabsorbed in the kidney.

Explain how water is reabsorbed in the kidney.

.....  
.....  
.....  
..... [2]

(c) Describe what happens to the urine after leaving the kidney tubule at X on Fig. 4.1.

.....  
.....  
.....  
..... [2]

(d) Describe the functions of the liver in excretion.

.....  
.....  
.....  
.....  
.....  
..... [3]

[Total: 10]

5 (a) Four definitions of terms used in genetics are shown in Table 5.1.

For  
Examiner's  
Use

Table 5.1

definitions	terms
the outward appearance of an organism	.....
a length of DNA that codes for a protein	.....
having one set of chromosomes	.....
type of nuclear division which gives daughter nuclei that are genetically identical	.....

For each of the definitions, select an appropriate term from the list and write it in the box provided.

- |            |              |           |
|------------|--------------|-----------|
| chromosome | genotype     | mitosis   |
| diploid    | haploid      | mutation  |
| dominant   | heterozygous | phenotype |
| gene       | homozygous   | recessive |

[4]

(b) A couple who have blood groups **A** and **B** have four children. Each child has a different blood group.

Use the space below to draw a genetic diagram to show how this is possible. Use the symbols,  $I^A$ ,  $I^B$  and  $I^o$ , for the alleles.

parental blood groups		<b>A</b>	×	<b>B</b>	
parental genotypes		.....	×	.....	
gamete genotypes		.....		.....	
children's genotypes	.....	.....		.....	.....
children's blood groups	.....	.....		.....	.....

[4]

(c) Explain what is meant by *codominance*. You may refer to the genetic diagram in (b) to help you with your answer.

.....  
.....  
.....  
.....  
.....  
.....  
..... [3]

(d) Insulin produced by genetically engineered bacteria first became available in 1982. Before 1982, insulin had been prepared from dead animal tissues.

Explain the **advantages** of using insulin produced by genetically engineered bacteria rather than insulin from dead animal tissues.

.....  
.....  
.....  
.....  
.....  
.....  
..... [3]

For  
Examiner's  
Use

(e) Fig. 5.1 shows some of the steps involved in the genetic engineering of bacteria.

For  
Examiner's  
Use

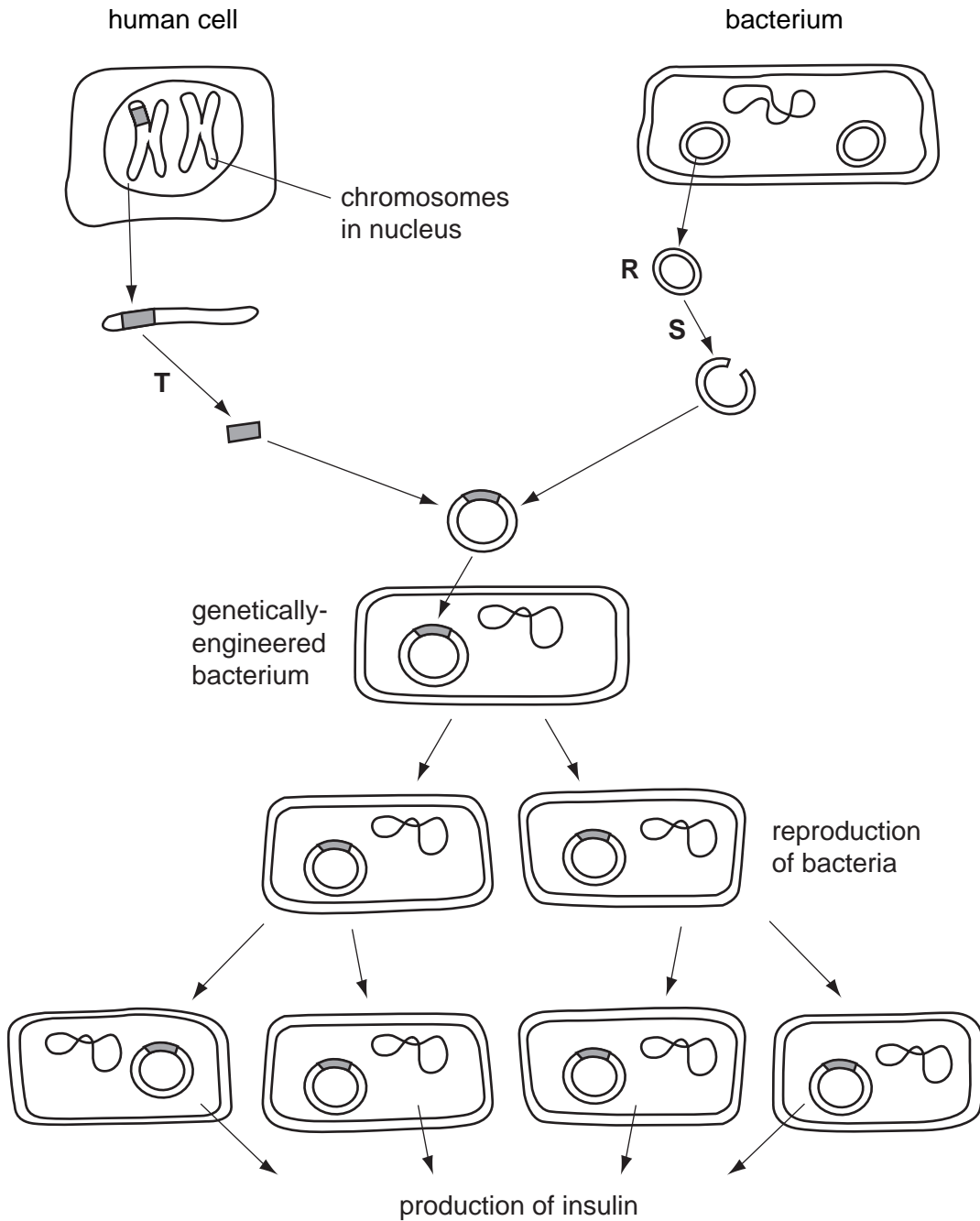

**Fig. 5.1**

(i) Name structure **R** and state what it is made from.

..... [2]

(ii) State what is added at stages **S** and **T**.

..... [1]

[Total: 17]

**BLANK PAGE**

**QUESTION 6 STARTS ON THE NEXT PAGE.**

6 (a) List four chemical elements that are found in proteins.

- 1. ....
- 2. ....
- 3. ....
- 4. .... [4]

Fig. 6.1 is a photograph of some root nodules from a pea plant, which is a type of legume.



Fig. 6.1

(b) Nodules like those in Fig. 6.1 develop on the roots of pea plants and other legumes when the soil is lacking in nitrate ions.

Explain what happens inside the nodule to help legume plants grow in soils lacking nitrate ions.

.....

.....

.....

.....

.....

.....

..... [3]



(c) After the peas have been harvested, the plants are ploughed back into the soil.

Describe what happens in the soil to convert dead plant material into nitrate ions that plants can absorb.

.....  
.....  
.....  
.....  
.....  
.....  
.....  
.....  
.....  
.....  
..... [6]

(d) Nutrients in the soil can act as a limiting factor for crop growth.

List three **other** factors that may limit the growth of a crop plant.

1. ....  
2. ....  
3. .... [3]

For  
Examiner's  
Use

QUESTION 6 CONTINUES ON PAGE 18

- (e) The soya bean aphid is an insect pest of soya bean plants in North America. The aphids can show an exponential growth rate where populations can double in two to three days under favourable conditions.

For  
Examiner's  
Use

Fig. 6.2 shows the growth of soya bean aphids in a field in North America during the growing season.

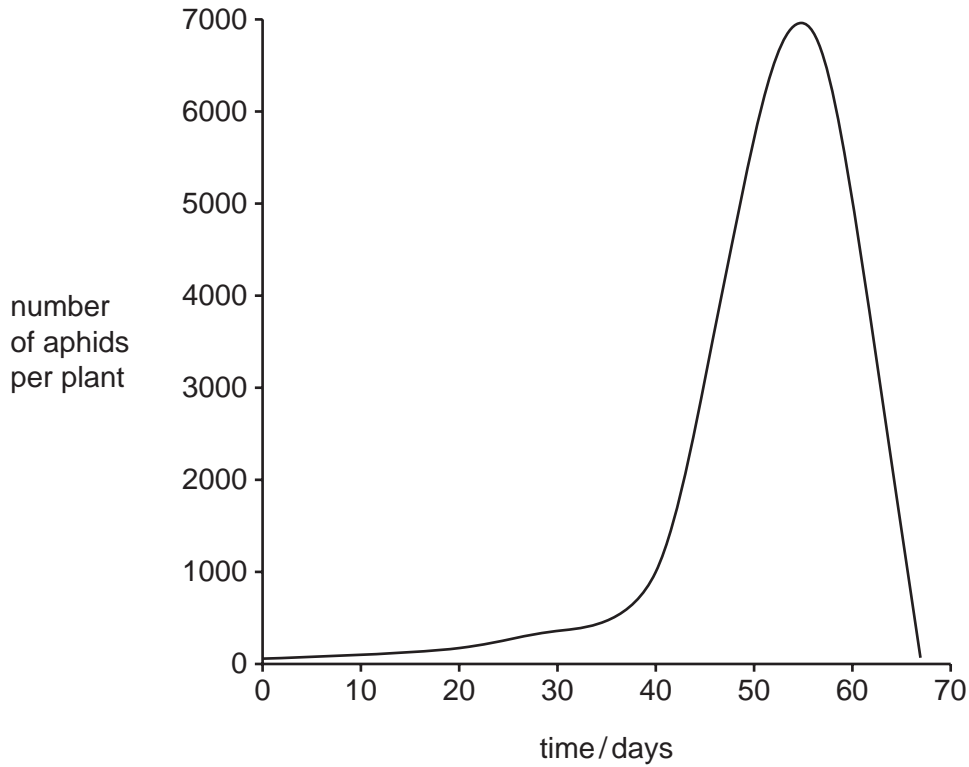

Fig. 6.2

Suggest why the population of aphids did not increase rapidly until about day 40.

.....

.....

.....

.....

.....

.....

..... [3]

[Total: 19]



---

*Copyright Acknowledgements:*

Fig. 6.1 (c) DR.JEREMY BURGESS / SCIENCE PHOTO LIBRARY.

Permission to reproduce items where third-party owned material protected by copyright is included has been sought and cleared where possible. Every reasonable effort has been made by the publisher (UCLES) to trace copyright holders, but if any items requiring clearance have unwittingly been included, the publisher will be pleased to make amends at the earliest possible opportunity.

University of Cambridge International Examinations is part of the Cambridge Assessment Group. Cambridge Assessment is the brand name of University of Cambridge Local Examinations Syndicate (UCLES), which is itself a department of the University of Cambridge.