



MATHEMATICAL STUDIES
STANDARD LEVEL
PAPER 1

Friday 9 November 2001 (afternoon)

1 hour

Name

--

Number

--	--	--	--	--	--	--	--

INSTRUCTIONS TO CANDIDATES

- Write your name and candidate number in the boxes above.
- Do not open this examination paper until instructed to do so.
- Answer all the questions in the spaces provided.
- Unless otherwise stated in the question, all numerical answers must be given exactly or to three significant figures, as appropriate.
- Write the make and model of your calculator in the box below *e.g.* Casio *fx-9750G*, Sharp EL-9600, Texas Instruments TI-85.

Calculator

Make	Model

EXAMINER	TEAM LEADER	IBCA
TOTAL /60	TOTAL /60	TOTAL /60

2. The bar chart below shows the number of people in a selection of families.

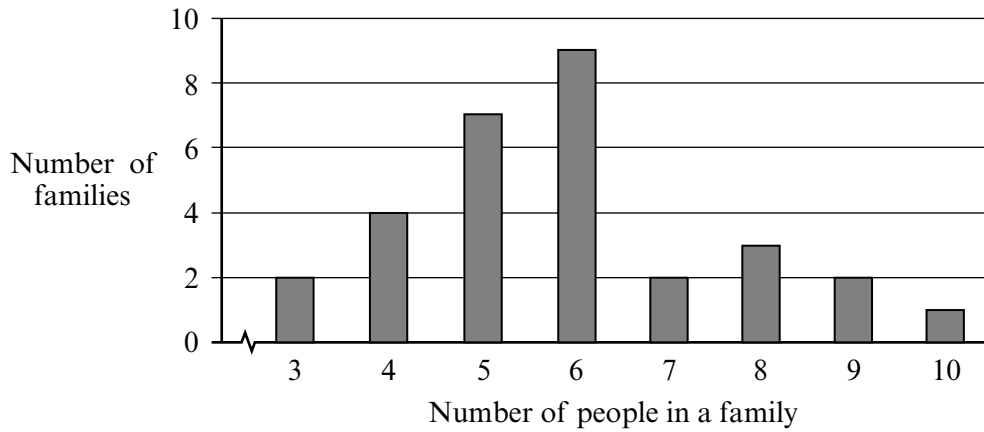

- (a) How many families are represented?
- (b) Write down the mode of the distribution.
- (c) Find, correct to the nearest whole number, the mean number of people in a family.

Working:

Answers:

- (a) _____
- (b) _____
- (c) _____

3. Two propositions p and q are defined as follows.

p : Jones passed this course

q : Smith passed this course

(a) Write in symbolic form

(i) neither Jones nor Smith passed the course ;

(ii) it is not the case that Jones and Smith both passed the course.

(b) Complete the following truth table for the logic statement $\neg p \vee q$.

p	q	$\neg p$	$\neg p \vee q$
T	T		
T	F		
F	T		
F	F		

Working:

Answers:

(a) (i) _____

(ii) _____

4. The following is part of a display on the notice board of a bank in the United Kingdom. It shows the exchange rate between one British pound (GBP) and other currencies.

EXCHANGE RATES		
	Bank buys foreign currency	Bank sells foreign currency
Denmark (KR)	11.38	10.78
Finland (MKK)	7.00	6.60
France (FFR)	10.05	9.45
Germany (DM)	2.854	2.798
Greece (DR)	292	266
NO COMMISSION CHARGED		

Geraldine eats a meal in a restaurant while on holiday in Greece. The meal costs 4256 drachma (DR).

- (a) Use the **bank-selling** price to calculate the cost of the meal in British pounds.

The Williams family go to Germany. Before leaving, they change GBP 600 into German marks.

- (b) Calculate the number of German marks they receive for GBP 600, giving your answer correct to **two** decimal places.

They spend DM 824 in Germany, and on returning to the United Kingdom, they change their remaining German marks into British pounds.

- (c) Calculate the number of British pounds they receive, correct to **two** decimal places.

Working:

Answers:

(a) _____

(b) _____

(c) _____

5. The equation of a line l_1 is $y = \frac{1}{2}x$.

(a) On the grid, draw and label the line l_1 .

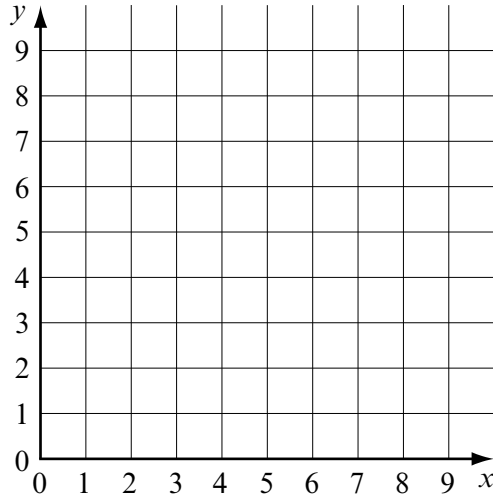

The line l_2 has the same gradient as l_1 but crosses the y -axis at 3.

- (b) What is the geometric relationship between l_1 and l_2 ?
- (c) Write down the equation of l_2 .
- (d) On the same grid as in part (a), draw the line l_2 .

Working:

Answers:

(b) _____

(c) _____

6. In the triangle OAB, P is the mid-point of AB, X is the mid-point of OB, $\vec{OA} = \mathbf{a}$ and $\vec{OB} = \mathbf{b}$.

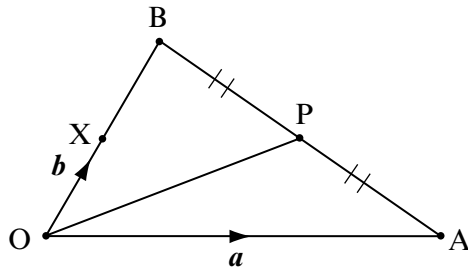

Diagram not to scale

Express the following vectors in terms of \mathbf{a} and \mathbf{b}

- (a) \vec{AB} ;
- (b) \vec{OP} ;
- (c) \vec{AX} .

Working:

Answers:

- (a) _____
- (b) _____
- (c) _____

7. The first four terms of an arithmetic sequence are shown below.

1, 5, 9, 13,

- (a) Write down the n^{th} term of the sequence.
- (b) Calculate the 100th term of the sequence.
- (c) Find the sum of the first 100 terms of the sequence.

Working:

Answers:

- (a) _____
- (b) _____
- (c) _____

8. The diagram shows a cuboid 22.5 cm by 40 cm by 30 cm.

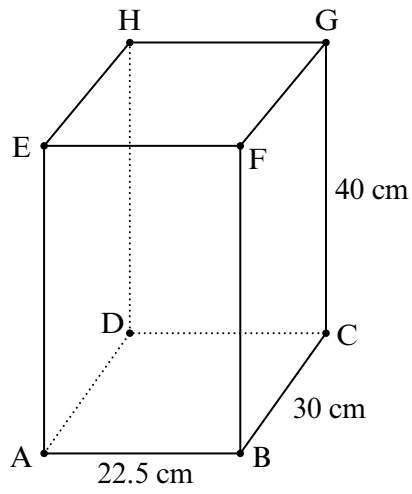

(a) Calculate the length of $[AC]$.

(b) Calculate the size of \widehat{GAC} .

Working:

Answers:

(a) _____

(b) _____

9. A committee U has three sub-committees: research R , finance F and purchasing P . No member belongs to both finance and purchasing sub-committees. Some members belong to both research and purchasing committees. All members of the finance sub-committee also belong to the research sub-committee.

Draw a Venn diagram, showing the relationship between the sets U , R , F and P .

Answer:

10. Write down the three inequalities that define the shaded region (R), shown in the diagram below.

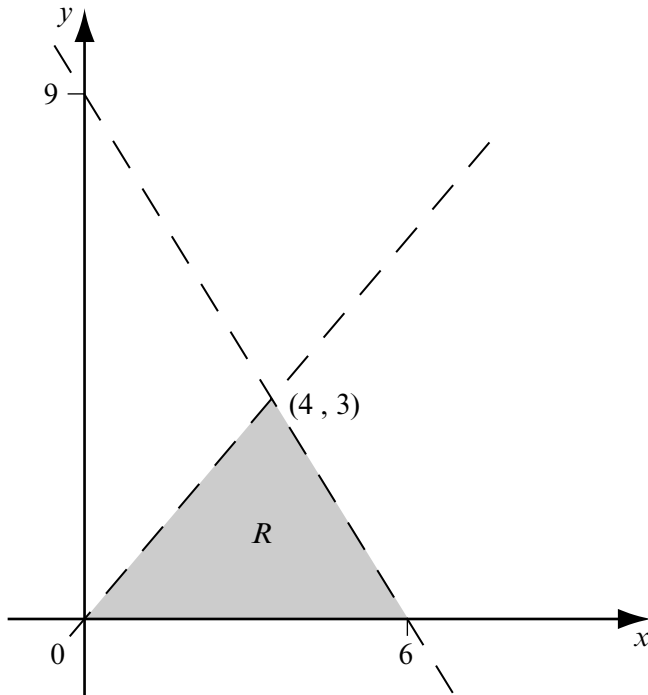

Diagram not to scale

Working:

Answers:

11. (a) Factorise the expression $2x^2 - 3x - 5$.
(b) Hence, or otherwise, solve the equation $2x^2 - 3x = 5$.

Working:

Answers:

(a) _____

(b) _____

12. A teacher has a box containing six type A calculators and four type B calculators.

The probability that a type A calculator is faulty is 0.1 and the probability that a type B calculator is faulty is 0.12 .

(a) Complete the tree diagram given below, showing all the probabilities.

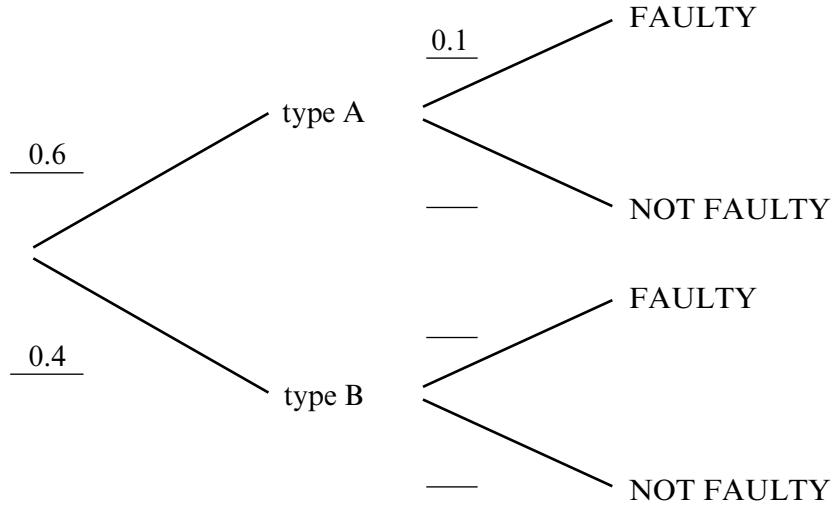

(b) A calculator is selected at random from the box. Find the probability that the calculator is

- (i) a faulty type A ;
- (ii) not faulty.

<p><i>Working:</i></p>	<p><i>Answers:</i></p> <p>(b) (i) _____</p> <p>(ii) _____</p>
------------------------	---

13. In the diagram the shaded region represents a circular track with centre O , within a square field PQRS. The outer edge of the track touches the sides of the field. The radii of the inner and outer edges of the track are x m and y m respectively.

Diagram not to scale

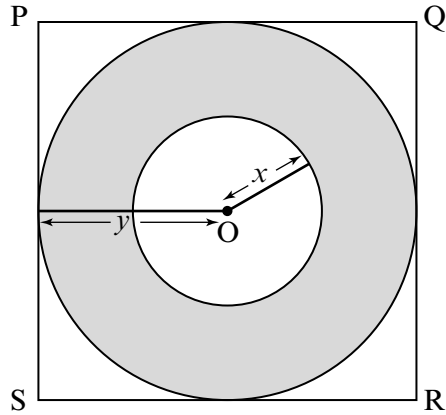

- (a) Write down an expression for the area of the track.
- (b) The area of the field PQRS is 4900 m^2 .
 - (i) Find y .
 - (ii) Given that $x = 21$, find the area of the track.

Working:

Answers:

(a) _____

(b) (i) _____

(ii) _____

14. The graph below shows the curve $y = k(2^x) + c$, where k and c are constants.

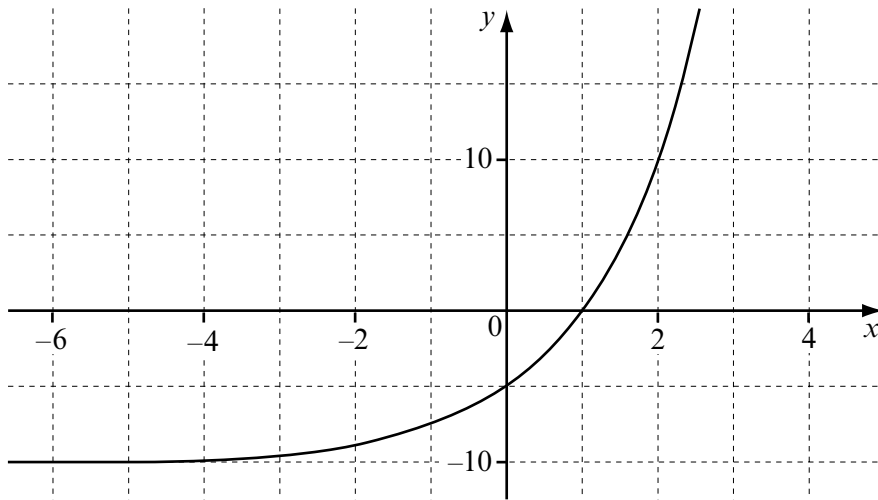

Find the values of c and k .

Working:

Answers:

15. A ski lift travels in a straight line between two points, A and B. The coordinates of A and B are $(100, 0, 300)$ and $(200, 250, 0)$ respectively, where 1 unit represents 1 metre.

Heidi is travelling to the top of the ski lift at B. She is now at point M, halfway between A and B.

- (a) Write down the coordinates of M.
- (b) How far does Heidi still have to travel to reach B?

Working:

Answers:

(a) _____

(b) _____
