

BLANK PAGE



Leave blank

Los deportes

¿Qué deporte?

Lee las preguntas siguientes.

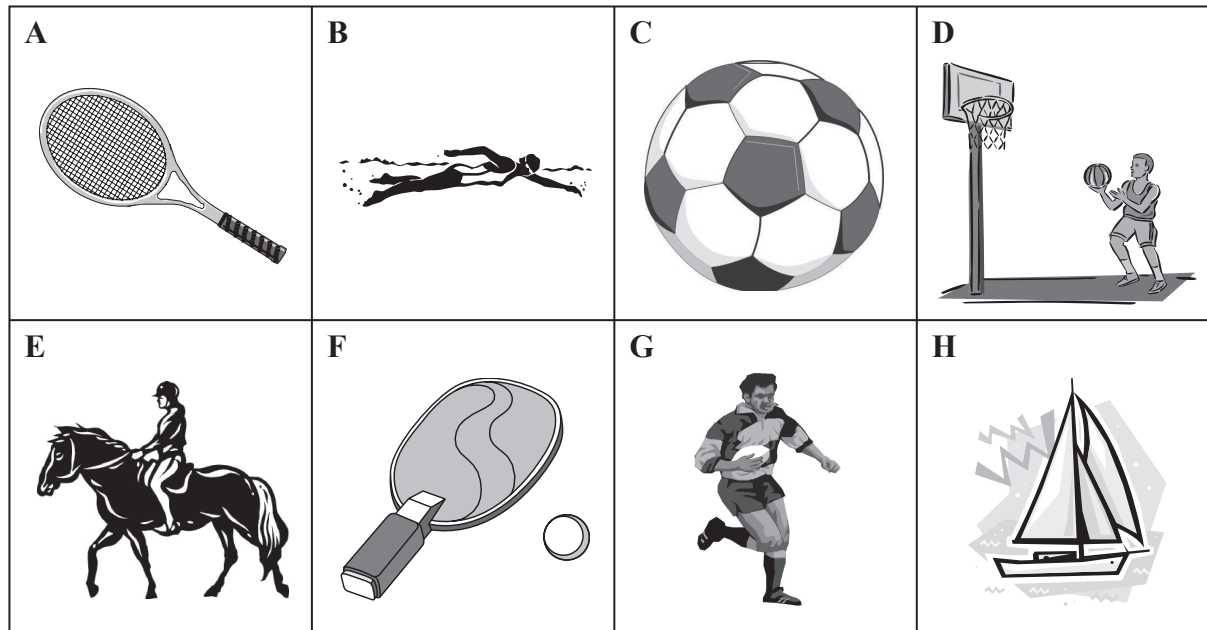

Pon una equis (☒) en la casilla adecuada.

	A	B	C	D	E	F	G	H
Ejemplo:	<input type="checkbox"/>	<input type="checkbox"/>	<input checked="" type="checkbox"/>	<input type="checkbox"/>	<input type="checkbox"/>	<input type="checkbox"/>	<input type="checkbox"/>	<input type="checkbox"/>
1.	<input type="checkbox"/>	<input type="checkbox"/>	<input type="checkbox"/>	<input type="checkbox"/>	<input type="checkbox"/>	<input type="checkbox"/>	<input type="checkbox"/>	<input type="checkbox"/>
2.	<input type="checkbox"/>	<input type="checkbox"/>	<input type="checkbox"/>	<input type="checkbox"/>	<input type="checkbox"/>	<input type="checkbox"/>	<input type="checkbox"/>	<input type="checkbox"/>
3.	<input type="checkbox"/>	<input type="checkbox"/>	<input type="checkbox"/>	<input type="checkbox"/>	<input type="checkbox"/>	<input type="checkbox"/>	<input type="checkbox"/>	<input type="checkbox"/>
4.	<input type="checkbox"/>	<input type="checkbox"/>	<input type="checkbox"/>	<input type="checkbox"/>	<input type="checkbox"/>	<input type="checkbox"/>	<input type="checkbox"/>	<input type="checkbox"/>
5.	<input type="checkbox"/>	<input type="checkbox"/>	<input type="checkbox"/>	<input type="checkbox"/>	<input type="checkbox"/>	<input type="checkbox"/>	<input type="checkbox"/>	<input type="checkbox"/>

Q1-5

(Total 5 marks)



Mi casa

Rosa habla de su casa.



Lee las preguntas siguientes.

Pon una equis (☒) en la casilla adecuada.

Ejemplo: ¿Dónde vive?

A	B	C
Madrid	Barcelona	Toledo
<input type="checkbox"/>	<input type="checkbox"/>	<input checked="" type="checkbox"/>

6. Vive en

A	B	C
		
<input type="checkbox"/>	<input type="checkbox"/>	<input checked="" type="checkbox"/>

(1)

7. Hay

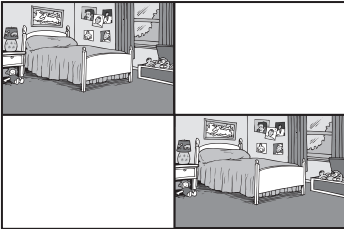
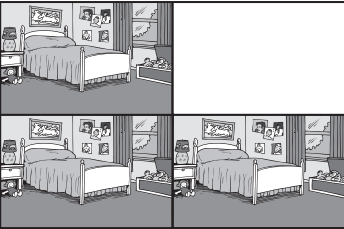
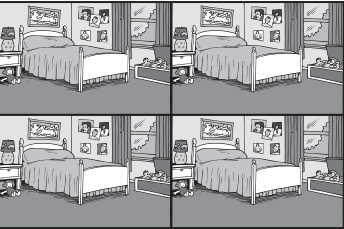

A	B	C
		
<input type="checkbox"/>	<input type="checkbox"/>	<input checked="" type="checkbox"/>

(1)



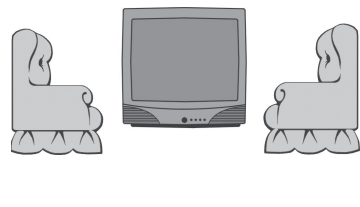
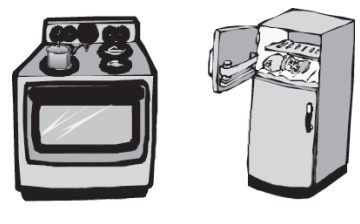

Leave blank

8. También hay

A 	B 	C 
<input type="checkbox"/>	<input type="checkbox"/>	<input type="checkbox"/>

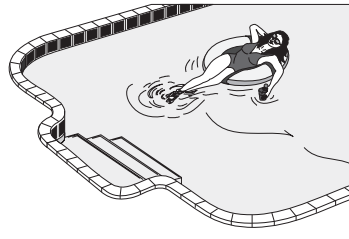

(1)

9. Afuera hay

A 	B 	C 
<input type="checkbox"/>	<input type="checkbox"/>	<input type="checkbox"/>

(1)

10. No hay

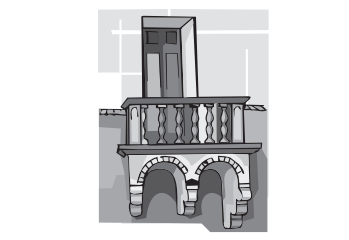
A 	B 	C 
<input type="checkbox"/>	<input type="checkbox"/>	<input type="checkbox"/>

(1)

(Total 5 marks)

Q6-10



El tiempo libre

Unos jóvenes hablan de su tiempo libre.

Lee la lista siguiente.

¿Qué les interesa?

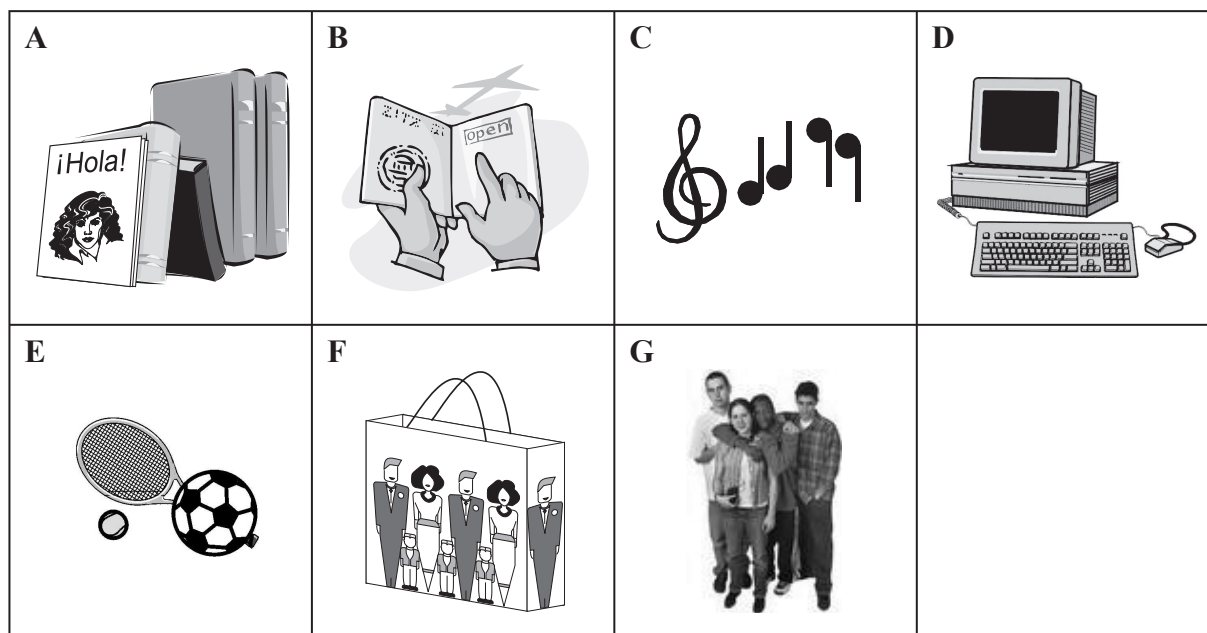

Pon una equis (☒) en la casilla adecuada.

	A	B	C	D	E	F	G
Ejemplo: Fabio	<input checked="" type="checkbox"/>	<input checked="" type="checkbox"/>	<input checked="" type="checkbox"/>	<input checked="" type="checkbox"/>	<input checked="" type="checkbox"/>	<input checked="" type="checkbox"/>	<input checked="" type="checkbox"/>
11. Candi	<input type="checkbox"/>	<input type="checkbox"/>	<input type="checkbox"/>	<input type="checkbox"/>	<input type="checkbox"/>	<input type="checkbox"/>	<input type="checkbox"/>
12. Ramón	<input type="checkbox"/>	<input type="checkbox"/>	<input type="checkbox"/>	<input type="checkbox"/>	<input type="checkbox"/>	<input type="checkbox"/>	<input type="checkbox"/>
13. Loli	<input type="checkbox"/>	<input type="checkbox"/>	<input type="checkbox"/>	<input type="checkbox"/>	<input type="checkbox"/>	<input type="checkbox"/>	<input type="checkbox"/>
14. Vito	<input type="checkbox"/>	<input type="checkbox"/>	<input type="checkbox"/>	<input type="checkbox"/>	<input type="checkbox"/>	<input type="checkbox"/>	<input type="checkbox"/>
15. Soledad	<input type="checkbox"/>	<input type="checkbox"/>	<input type="checkbox"/>	<input type="checkbox"/>	<input type="checkbox"/>	<input type="checkbox"/>	<input type="checkbox"/>

Q11-15

(Total 5 marks)



Leave
blank

Un atraco

16. ¿Qué pasó?

Lee la pregunta siguiente.

Completa el formulario **en español**.

Policía Municipal

Ejemplo: Nombre: *María García*

(a) ¿Dónde?: (1)

(b) ¿Cuándo?: (1)

(c) Descripción del ladrón:
..... (2)

(d) ¿Objeto robado?: (1)

(Total 5 marks)

Q16

7

Turn over



Sevilla

¿Qué hay?

Lee las preguntas siguientes.

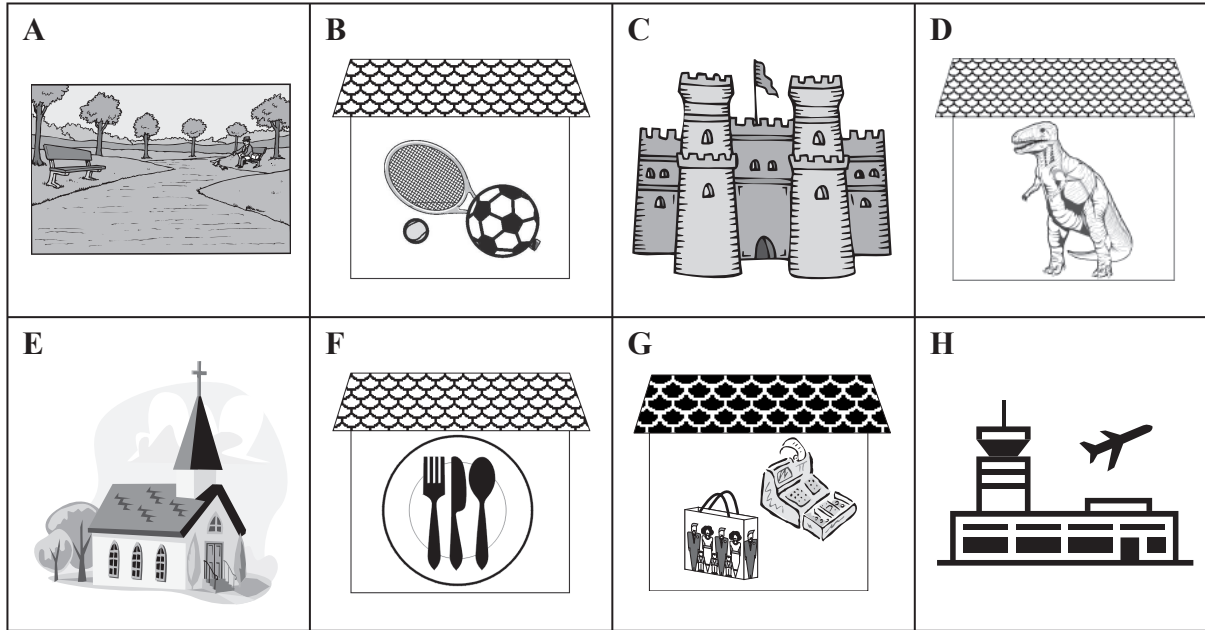

Pon una equis (☒) en la casilla adecuada.

	A	B	C	D	E	F	G	H
Ejemplo:	<input type="checkbox"/>	<input type="checkbox"/>	<input type="checkbox"/>	<input type="checkbox"/>	<input type="checkbox"/>	<input checked="" type="checkbox"/>	<input type="checkbox"/>	<input type="checkbox"/>
17.	<input type="checkbox"/>	<input type="checkbox"/>	<input type="checkbox"/>	<input type="checkbox"/>	<input type="checkbox"/>	<input type="checkbox"/>	<input type="checkbox"/>	<input type="checkbox"/>
18.	<input type="checkbox"/>	<input type="checkbox"/>	<input type="checkbox"/>	<input type="checkbox"/>	<input type="checkbox"/>	<input type="checkbox"/>	<input type="checkbox"/>	<input type="checkbox"/>
19.	<input type="checkbox"/>	<input type="checkbox"/>	<input type="checkbox"/>	<input type="checkbox"/>	<input type="checkbox"/>	<input type="checkbox"/>	<input type="checkbox"/>	<input type="checkbox"/>
20.	<input type="checkbox"/>	<input type="checkbox"/>	<input type="checkbox"/>	<input type="checkbox"/>	<input type="checkbox"/>	<input type="checkbox"/>	<input type="checkbox"/>	<input type="checkbox"/>
21.	<input type="checkbox"/>	<input type="checkbox"/>	<input type="checkbox"/>	<input type="checkbox"/>	<input type="checkbox"/>	<input type="checkbox"/>	<input type="checkbox"/>	<input type="checkbox"/>

Q17-21

(Total 5 marks)



Leave
blank

Las vacaciones

22. Nina habla de sus vacaciones.

Lee las preguntas siguientes.

¿Qué menciona?

Pon una equis (☒) en las 5 casillas apropiadas.

(a) el viaje	<input type="checkbox"/>
(b) la duración	<input type="checkbox"/>
(c) la cultura	<input type="checkbox"/>
(d) las instalaciones	<input type="checkbox"/>
(e) el tiempo	<input type="checkbox"/>
(f) el ambiente	<input type="checkbox"/>
(g) el alojamiento	<input type="checkbox"/>
(h) el precio	<input type="checkbox"/>
(i) la comida	<input type="checkbox"/>
(j) las actividades	<input type="checkbox"/>

Q22

(Total 5 marks)

9

Turn over



N 3 3 7 1 9 A 0 9 1 6



El colegio

23a. Juan habla de su colegio.



Lee las preguntas siguientes.

Pon una equis (☒) en las casillas apropiadas.

Ejemplo: Es un colegio



<p>A</p> 	<p>B</p> 	<p>C</p> 
<input checked="" type="checkbox"/>	<input type="checkbox"/>	<input type="checkbox"/>

(i) Número de alumnos

<p>A</p>  <p>500</p>	<p>B</p>  <p>600</p>	<p>C</p>  <p>1.000</p>
<input type="checkbox"/>	<input type="checkbox"/>	<input type="checkbox"/>



(1)

(ii) Le gusta

<p>A</p> 	<p>B</p> 	<p>C</p> 
<input type="checkbox"/>	<input type="checkbox"/>	<input type="checkbox"/>

(1)

(iii) No le gusta

<p>A</p> 	<p>B</p> 	<p>C</p> 
<input type="checkbox"/>	<input type="checkbox"/>	<input type="checkbox"/>

(1)



Q23a

(Total 3 marks)



Leave blank

23b. (i) Las clases empiezan

A 	B 	C 
<input type="checkbox"/>	<input type="checkbox"/>	<input type="checkbox"/>

(1)

(ii) Actividades extraescolares

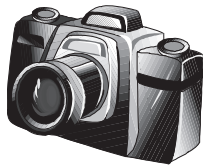
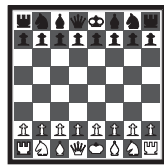
A 	B 	C 
<input type="checkbox"/>	<input type="checkbox"/>	<input type="checkbox"/>

(1)

Q23b

(Total 2 marks)



BLANK PAGE











Leave blank

En la cafetería

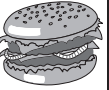
¿Qué quieren?

Lee las preguntas siguientes.

Pon una equis (☒) en las casillas adecuadas.

	A	B	C	D	E	F	G	H
								
Ejemplo:	<input type="checkbox"/>	<input type="checkbox"/>	<input type="checkbox"/>	<input checked="" type="checkbox"/>	<input type="checkbox"/>	<input type="checkbox"/>	<input type="checkbox"/>	<input type="checkbox"/>
24.	<input type="checkbox"/>	<input type="checkbox"/>	<input type="checkbox"/>	<input type="checkbox"/>	<input type="checkbox"/>	<input type="checkbox"/>	<input type="checkbox"/>	<input type="checkbox"/>
25.	<input type="checkbox"/>	<input type="checkbox"/>	<input type="checkbox"/>	<input type="checkbox"/>	<input type="checkbox"/>	<input type="checkbox"/>	<input type="checkbox"/>	<input type="checkbox"/>
26.	<input type="checkbox"/>	<input type="checkbox"/>	<input type="checkbox"/>	<input type="checkbox"/>	<input type="checkbox"/>	<input type="checkbox"/>	<input type="checkbox"/>	<input type="checkbox"/>
27.	<input type="checkbox"/>	<input type="checkbox"/>	<input type="checkbox"/>	<input type="checkbox"/>	<input type="checkbox"/>	<input type="checkbox"/>	<input type="checkbox"/>	<input type="checkbox"/>
28.	<input type="checkbox"/>	<input type="checkbox"/>	<input type="checkbox"/>	<input type="checkbox"/>	<input type="checkbox"/>	<input type="checkbox"/>	<input type="checkbox"/>	<input type="checkbox"/>

Q24-28

(Total 5 marks)



Leave
blank

Answer the following questions **in English**.

The world of work

Adrián is talking about his career choices.

Read the following questions.

29. (a) What does Adrián want to do for a living?

..... (1)

(b) Why?

..... (1)

30. (a) What experience does Adrián have?

..... (1)

(b) What exactly does he do?

.....
..... (2)

(Total 5 marks)

**Q29-
30**



Leave
blank

Answer the following questions **in English**.

Family life

Mari Ángeles and Fernando are talking about their families.

Read the following questions.

31. (a) How many brothers and sisters does Mari Ángeles have?

..... (1)

(b) Mention **two** things she says about her brother.

.....
..... (2)

32. (a) What does Fernando say about his mother?

..... (1)

(b) What does he say about his father?

..... (1)

Q31-
32

(Total 5 marks)

TOTAL FOR PAPER: 50 MARKS

END



BLANK PAGE

