

Write your name here

Surname

Other names

Centre Number

Candidate Number

Edexcel GCSE

Biology/Science

Unit B1: Influences on Life

Higher Tier

Friday 1 March 2013 – Morning

Time: 1 hour

Paper Reference

5BI1H/01

You must have:

Calculator, ruler

Total Marks

Instructions

- Use **black** ink or ball-point pen.
- **Fill in the boxes** at the top of this page with your name, centre number and candidate number.
- Answer **all** questions.
- Answer the questions in the spaces provided
– *there may be more space than you need.*

Information

- The total mark for this paper is 60.
- The marks for **each** question are shown in brackets
– *use this as a guide as to how much time to spend on each question.*
- Questions labelled with an **asterisk** (*) are ones where the quality of your written communication will be assessed
– *you should take particular care with your spelling, punctuation and grammar, as well as the clarity of expression, on these questions.*

Advice

- Read each question carefully before you start to answer it.
- Keep an eye on the time.
- Try to answer every question.
- Check your answers if you have time at the end.

Turn over ►

P41955A

©2013 Pearson Education Ltd.

1/1/1/



PEARSON

BLANK PAGE



Answer ALL questions.

Some questions must be answered with a cross in a box ☒. If you change your mind about an answer, put a line through the box ☒ and then mark your new answer with a cross ☒.

Nervous system

1 The diagram shows a motor neurone.

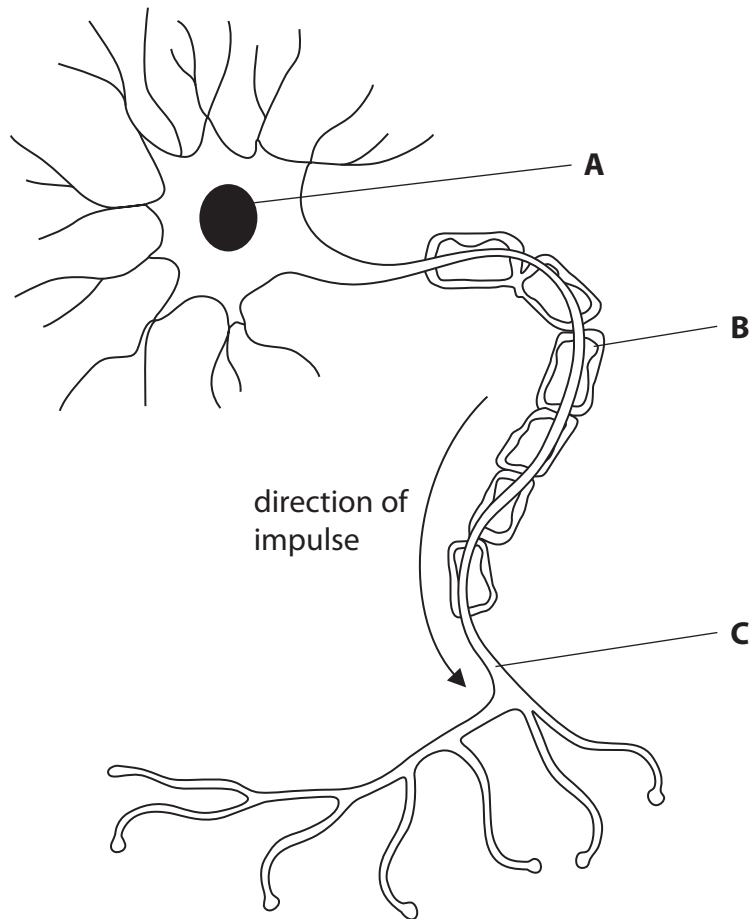

(a) (i) Name the structures labelled **A**, **B** and **C**.

(3)

A

B

C



(ii) When the brain receives impulses from receptor cells it coordinates a response.

Complete the sentence by putting a cross (☒) in the box next to your answer.

Responses are carried out by

(1)

- A alleles
- B dendrons
- C effectors
- D senses

(b) A response can be affected by drugs.

The effect of drinking alcohol on reaction time was investigated using five adult volunteers A, B, C, D and E.

After drinking a number of units of alcohol, the reaction time for each volunteer was measured three times.

The results are shown in the table.

Volunteer	Number of units of alcohol drunk	Reaction time / ms			
		1 st attempt	2 nd attempt	3 rd attempt	Mean
A	0.5	34	38	27	33
B	1.5	36	47	40	41
C	3.0	59	62	59	60
D	4.5	67	60	62	
E	6.0	80	68	83	77

(i) Calculate the mean reaction time for volunteer D.

(2)

Answerms



(ii) Explain why alcohol causes a change in reaction time.

(2)

.....

.....

.....

.....

(Total for Question 1 = 8 marks)



Darwin's finches

2 Charles Darwin studied the variety of finches on the Galapagos Islands.

He used this information to develop his theory of evolution.

Some of the finches are shown in the diagram.

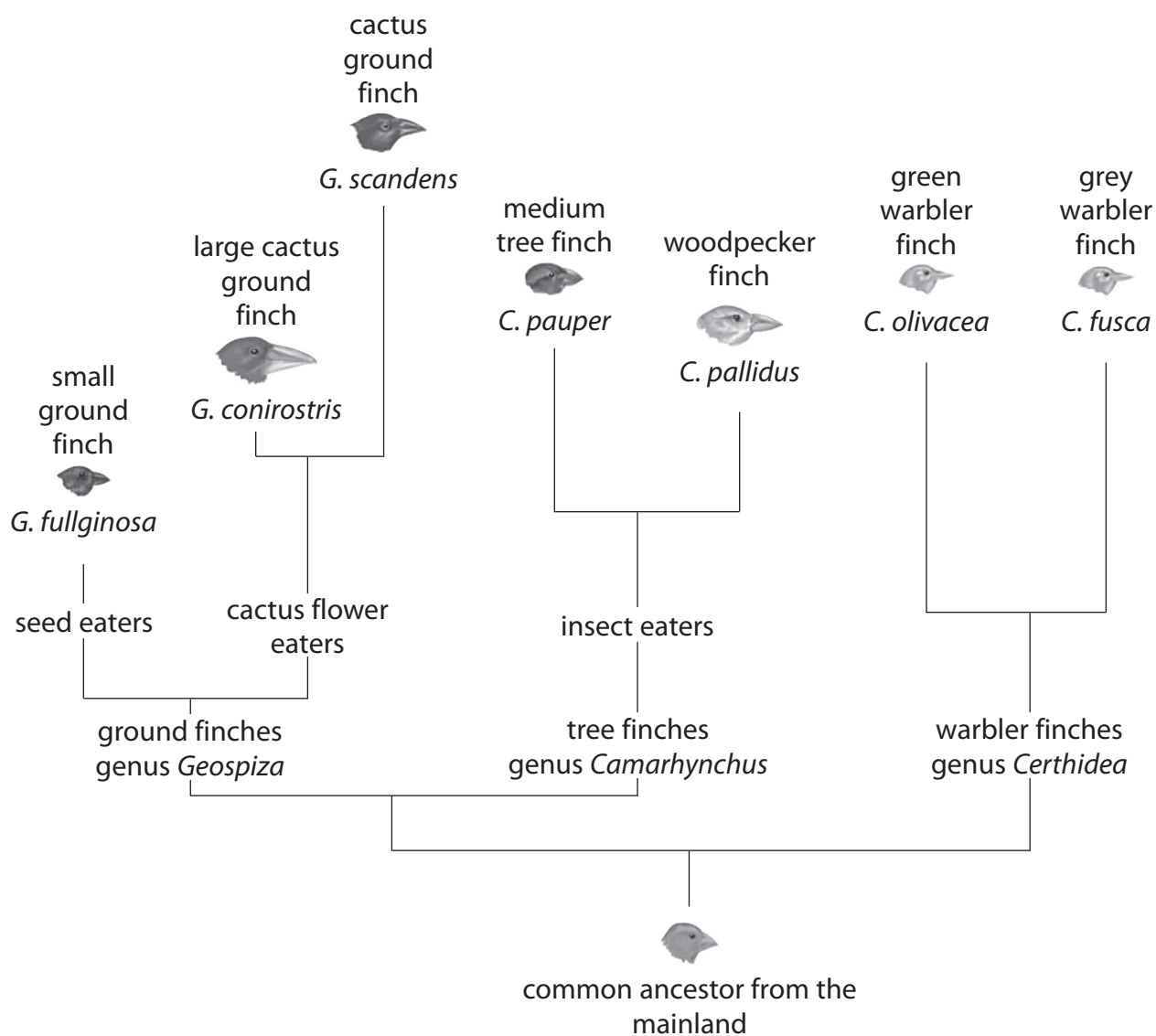

(a) (i) State the genus and the species of the large cactus ground finch.

(2)

genus.....

species.....



(ii) Suggest how the size and shape of their beaks enabled all of these types of finches to survive.

(2)

.....

.....

.....

.....

(iii) Complete the sentence by putting a cross (☒) in the box next to your answer.

Darwin's finches are an example of speciation due to

(1)

- A selective breeding
- B geographic isolation
- C hybridisation
- D the development of ring species

(b) Suggest how these species of finches could have evolved.

(3)

.....

.....

.....

.....

.....

.....

(Total for Question 2 = 8 marks)



Nitrogen

3 The diagram shows one of the stages of the nitrogen cycle.

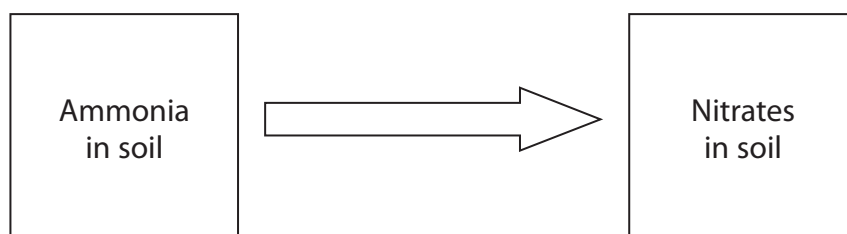

(a) (i) Complete the sentence by putting a cross (☒) in the box next to your answer.

The name of this stage is

(1)

- A decomposition
- B denitrification
- C nitrification
- D nitrogen fixation

(ii) Explain how plants use the nitrates from the soil.

(2)

.....

.....

.....

.....

(iii) Describe how the over-use of nitrate fertilisers can cause eutrophication.

(4)

.....

.....

.....

.....

.....

.....

.....

.....

.....

.....



(b) Leguminous plants such as beans and peas have bacteria growing inside nodules on their roots.

The diagram shows some nodules on a root.

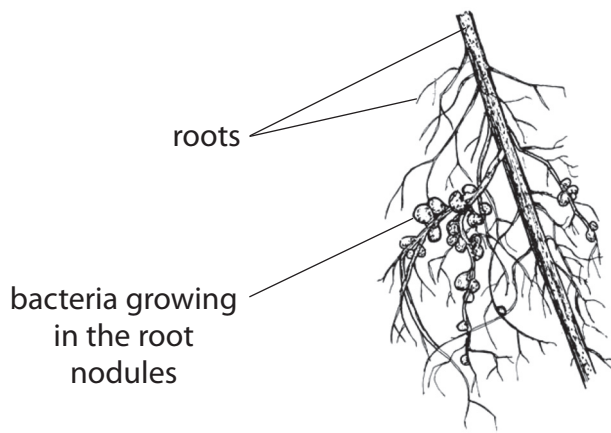

Explain the relationship between this bean plant and the bacteria growing in the root nodules.

(3)

.....

.....

.....

.....

.....

.....

(Total for Question 3 = 10 marks)



BLANK PAGE



Diabetes

4 The graph shows the percentage of the population with type 2 diabetes and the mean body mass of the population, from 1990 to 2000.

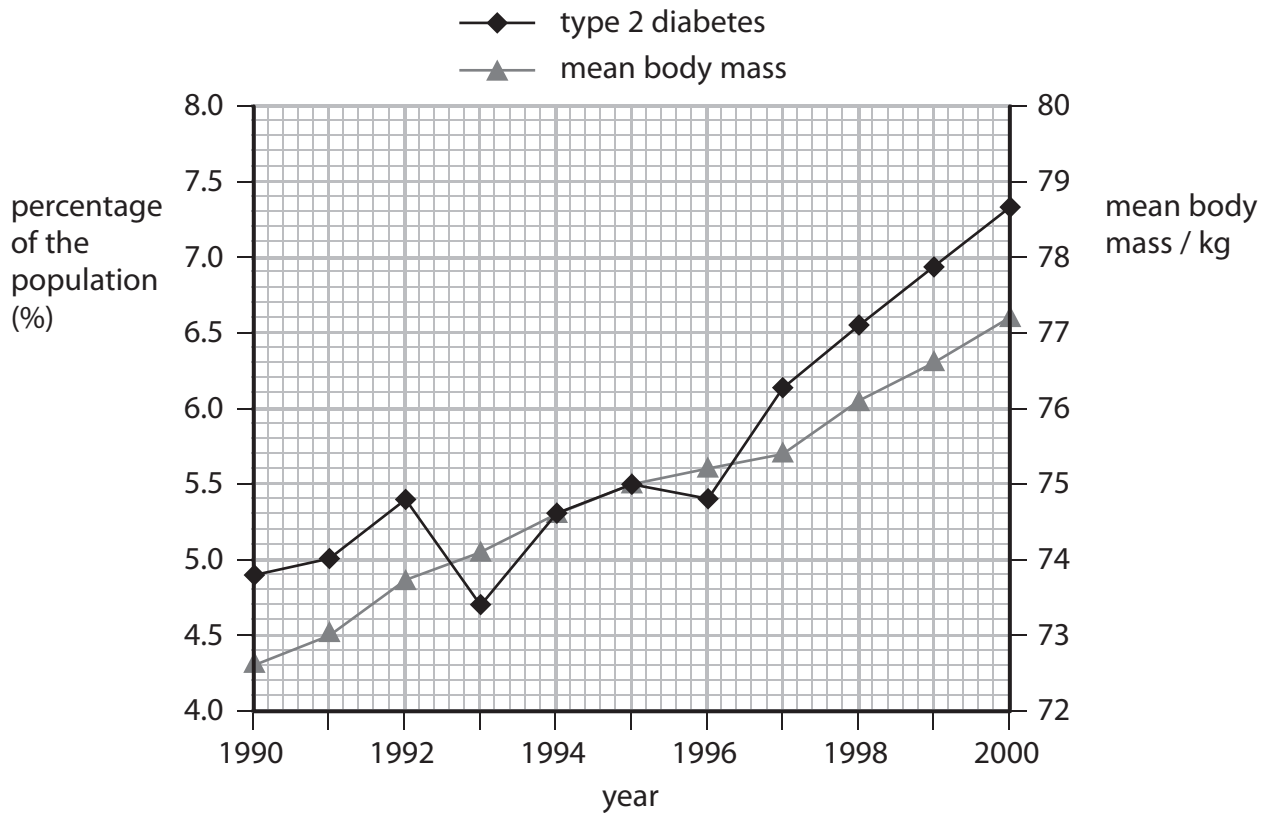

(a) (i) Use information from the graph to describe the correlation between type 2 diabetes and body mass shown from 1993 to 2000.

(2)

.....

.....

.....

.....

(ii) Suggest how a change in body mass may cause a person to develop type 2 diabetes.

(2)

.....

.....

.....

.....



(b) (i) Use the equation to calculate the body mass index (BMI) for a person with a body mass of 78 kg and a height of 1.7 m.

$$\text{BMI} = \frac{\text{mass / kg}}{(\text{height in metres})^2}$$

(2)

BMI

(ii) Use the chart to find the BMI category for this person.

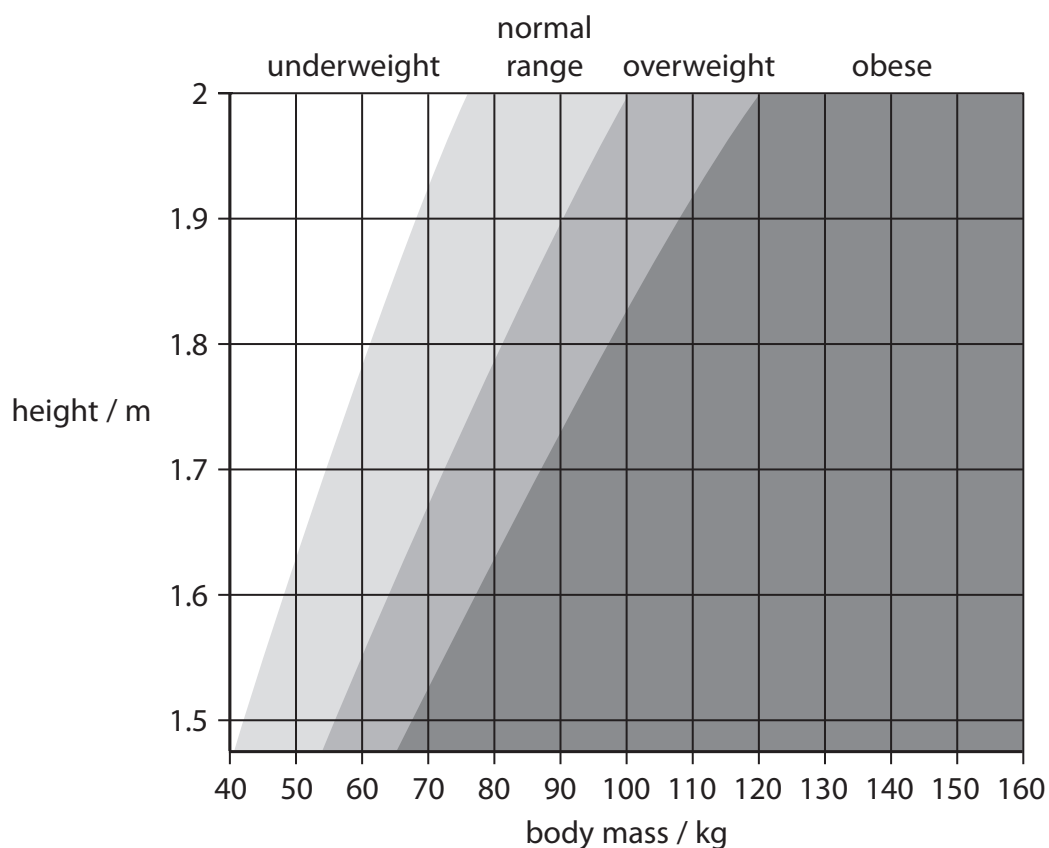

Complete the sentence by putting a cross (☒) in the box next to your answer.

The BMI category for this person is

(1)

- A** underweight
- B** normal range
- C** overweight
- D** obese



(c) Describe how the human body acts in response to low glucose levels in the blood.

(3)

.....

.....

.....

.....

.....

.....

(Total for Question 4 = 10 marks)



BLANK PAGE



Plant hormones

5 Auxins are plant hormones.

(a) (i) Complete the sentence by putting a cross (☒) in the box next to your answer.

Auxins cause the shoot of a plant to grow towards light in a process called (1)

- A negative gravitropism
- B negative phototropism
- C positive gravitropism
- D positive phototropism

(ii) Explain how auxins cause the shoot of a plant to grow towards light. (2)

.....

.....

.....

.....



(b) Ethylene (ethene) is a plant hormone that stimulates the ripening of fruit.

The graph shows the effect of ethylene (ethene) concentration on the ripening of bananas after three days.

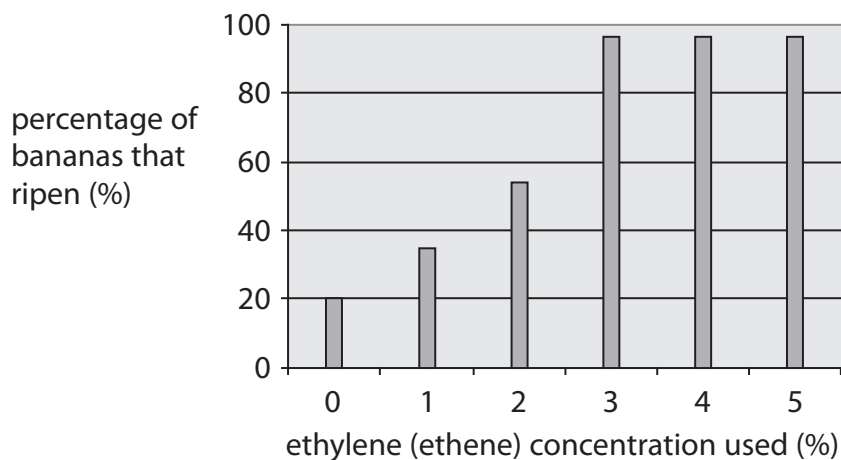

(i) Describe the effect of ethylene (ethene) on the ripening of bananas.

(1)

.....

.....

(ii) Explain which concentration of ethylene (ethene) a supermarket should use to be most cost effective when ripening bananas.

(2)

.....

.....

.....

.....



*(c) Fruit ripening is one use of plant hormones.

Describe the other uses of plant hormones in crop production.

(6)

A series of horizontal dotted lines provided for the student to write their answer.

(Total for Question 5 = 12 marks)



Genetic inheritance

- 6 The family pedigree shows the inheritance of sickle cell disease through three generations.

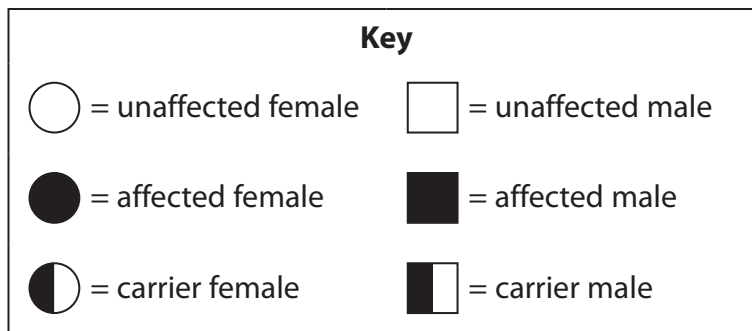
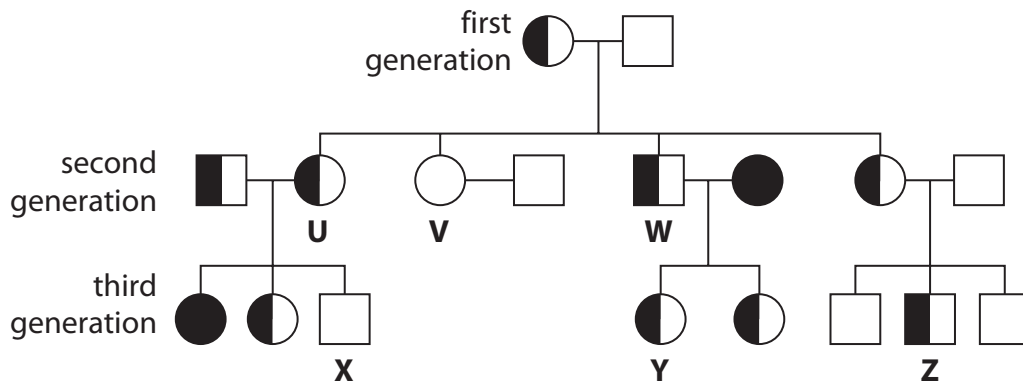

- (a) (i) Calculate the percentage of the offspring from the first generation who are heterozygous for sickle cell disease.

(1)

.....%

- (ii) Explain why the offspring produced by the first generation parents are not the same as those predicted in a Punnett square.

(2)

.....

.....

.....

.....



(iii) Person **W** and his partner have a third child.

State the probability that this child will have sickle cell disease.

Complete the Punnett square to show this.

(2)

probability

(iv) Complete the sentence by putting a cross (☒) in the box next to your answer.

The genotype of person **V** is

(1)

- A** homozygous dominant
- B** homozygous recessive
- C** heterozygous
- D** carrier



*(b) Explain why it is important that individuals **X**, **Y** and **Z** have pedigree analysis completed before they consider having children.

You should use diagrams and mathematical calculations to illustrate your answer.

(6)

.....

.....

.....

.....

.....

.....

.....

.....

.....

.....

.....

.....

.....

.....

.....

.....

.....

.....

.....

.....

.....

.....

.....

.....

.....

.....

.....

(Total for Question 6 = 12 marks)

TOTAL FOR PAPER = 60 MARKS

