

Surname					Other Names				
Centre Number					Candidate Number				
Candidate Signature									

General Certificate of Secondary Education
June 2003



**SCIENCE: DOUBLE AWARD (MODULAR)
BIOLOGY (MODULAR)
Maintenance of Life (Module 02)**

346002

Tuesday 24 June 2003 Morning Session

In addition to this paper you will require:

- an HB pencil and a rubber;
- an answer sheet.

You may use a calculator.

Time allowed: 30 minutes

Instructions

- Fill in the boxes at the top of this page.
- Check that your name, candidate number and centre number are printed on the separate answer sheet.
- Check that the separate answer sheet has the title “Maintenance of Life” printed on it.
- Attempt **one Tier only**, either the Foundation Tier **or** the Higher Tier.
- Answer **all** the questions for the Tier you are attempting.
- Make sure that you use the correct side of the separate answer sheet; the Foundation Tier is printed on one side and the Higher Tier on the other.
- Mark your responses on the separate answer sheet only. Rough work may be done on the question paper.
- Mark the best responses by using a thick pencil stroke to fill in the box. Use an HB pencil. Make sure the pencil stroke does **not** extend beyond the box. Do **not** use ink or ball-point pen. If you wish to change your answer, rub out your first answer completely. See below.

Examples:

	1	2	3	4
	<input type="checkbox"/>	<input type="checkbox"/>	<input checked="" type="checkbox"/>	<input type="checkbox"/>
	<input type="checkbox"/>	<input checked="" type="checkbox"/>	<input type="checkbox"/>	<input type="checkbox"/>
	<input type="checkbox"/>	<input type="checkbox"/>	<input type="checkbox"/>	<input checked="" type="checkbox"/>
	<input checked="" type="checkbox"/>	<input type="checkbox"/>	<input type="checkbox"/>	<input type="checkbox"/>

<input checked="" type="checkbox"/>
<input type="checkbox"/>
<input type="checkbox"/>
<input checked="" type="checkbox"/>
<input type="checkbox"/>

QUESTION XXX				
xxx.1	<input type="checkbox"/> A	<input checked="" type="checkbox"/> B	<input type="checkbox"/> C	<input type="checkbox"/> D
xxx.2	<input type="checkbox"/> A	<input type="checkbox"/> B	<input type="checkbox"/> C	<input checked="" type="checkbox"/> D
xxx.3	<input type="checkbox"/> A	<input checked="" type="checkbox"/> B	<input type="checkbox"/> C	<input type="checkbox"/> D
xxx.4	<input checked="" type="checkbox"/> A	<input type="checkbox"/> B	<input type="checkbox"/> C	<input type="checkbox"/> D

Information

- The maximum mark for this paper is 36.

Advice

- Do **not** choose more responses than you are asked to. You will lose marks if you do.
- Make sure that you hand in both your answer sheet and this question paper at the end of the test.
- If you start to answer on the wrong side of the answer sheet by mistake, make sure that you rub out **completely** the work that is not to be marked.

You must do **one Tier** only, **either** the Foundation Tier **or** the Higher Tier.
The Higher Tier starts on page 14 of this booklet.

FOUNDATION TIER

SECTION A

Questions **ONE** to **FIVE**.

In these questions match the words in the list with the numbers.

Use **each** answer only **once**.

Mark your choices on the answer sheet.

QUESTION ONE

A young puppy explores the garden of his new home.
The table is about the stimuli the puppy detects.

Match words from the list with each of the numbers **1–4** in the table.

ear

eye

nose

skin



Sense organ	Stimulus it detects
1	the shape of a flower pot
2	the temperature of a stone
3	the changing position of his body when jumping around
4	the chemicals given off by an earthworm

QUESTION TWO

The table is about the functions of organs involved in the removal of waste.

Match words from the list with each of the numbers 1–4 in the table.

bladder

kidney

liver

lung

Organ	Function
1	gets rid of carbon dioxide
2	produces urea
3	produces urine
4	stores urine

QUESTION THREE

The diagram shows some of the organs in the human body.

Match words from the list with each of the labels 1–4 on the diagram.

coordinates the body's responses

may develop emphysema

produces sweat

removes excess ions from the blood

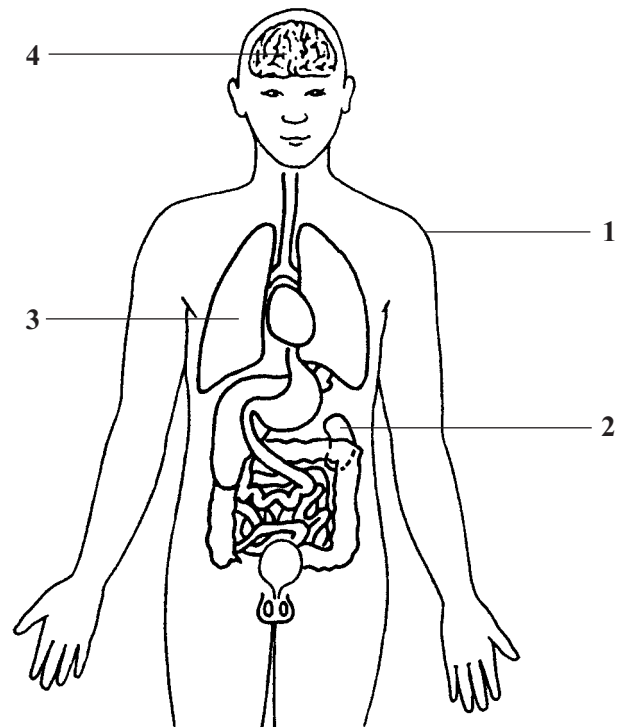

Turn over ►

QUESTION FOUR

The table is about the effects of some substances on the body.

Match words from the list with each of the numbers 1–4 in the table.

alcohol

carbon monoxide

nicotine

tobacco

Substance	Effect on body
1	may cause lung cancer
2	may cause damage to liver and brain
3	is the addictive substance in cigarettes
4	reduces the amount of oxygen which the blood carries

QUESTION FIVE

The diagram shows a plant cell.

Match words from the list with each of the labels 1–4 on the diagram.

contains a green substance

controls movement in and out of the cell

controls the activities of the cell

water in here supports young plants

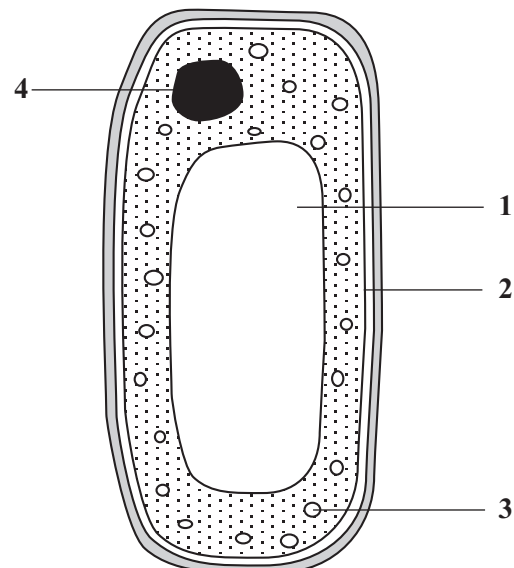

SECTION B

Questions **SIX** and **SEVEN**.

In these questions choose the best **two** answers.

Do **not** choose more than two.

Mark your choices on the answer sheet.

QUESTION SIX

Figure 1 shows two potted plants, **X** and **Y**, of the same age and size.



Figure 1

Plant **X** was placed in the light, but Plant **Y** was placed in a black box with a hole in one side.

Figure 2 shows the plants after 5 days.

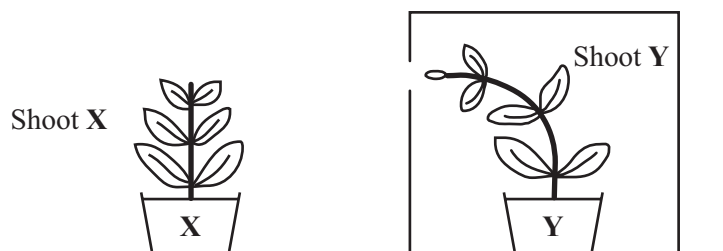

Figure 2

Which **two** of the following are correct?

both shoots have grown towards moisture

both shoots have grown in the direction of the force of gravity

shoot Y has grown against the force of gravity but shoot X has not

shoot Y has grown more than shoot X

shoot Y has grown towards light from one side but shoot X has not

Turn over ►

QUESTION SEVEN

Figure 1 shows a glass jar with an airtight lid containing freshly picked leaves.

Figure 2 shows the same jar after two hours. The inside of the jar is now covered with small drops of water.

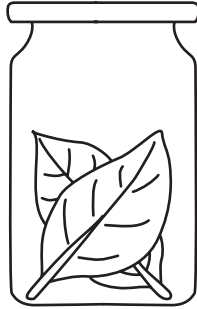

Figure 1

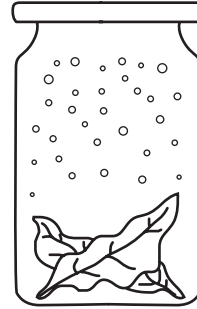

Figure 2

Which **two** of the following does this experiment show?

the leaves had no cuticle

the leaves had photosynthesised

the leaves had respired

the leaves had transpired

the leaves had wilted

SECTION CQuestions **EIGHT** to **TEN**.

Each of these questions has four parts.

In each part choose only **one** answer.Mark your choices on the answer sheet.

QUESTION EIGHT

The diagram shows a section through the eye of a frog.

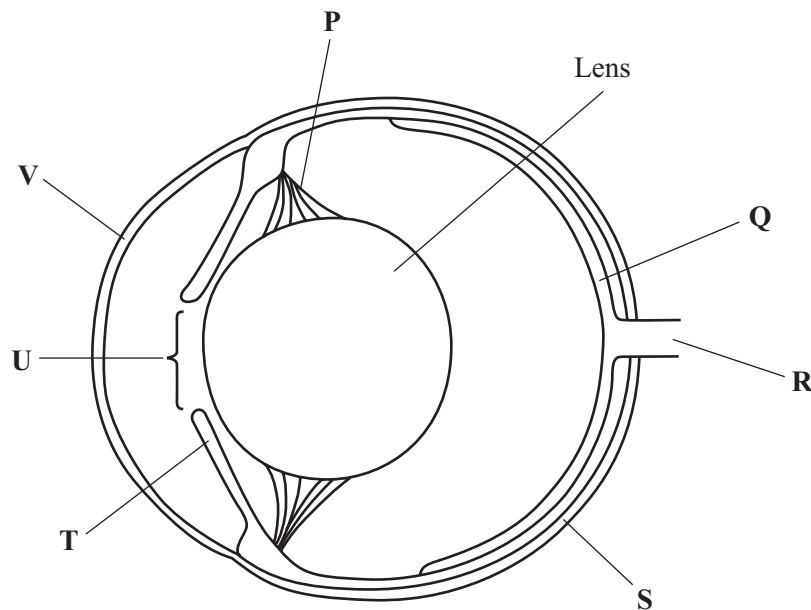

8.1 Which part of the eye is most likely to be the cornea?

- A Q
- B R
- C S
- D V

8.2 Which part is most likely to be the iris?

- A S
- B T
- C U
- D V

8.3 Structure **P** is most likely to be a

- A** ciliary muscle.
- B** pupil.
- C** retina.
- D** suspensory ligament.

8.4 Receptor cells sensitive to light are most likely to be found in

- A** **Q**
- B** **R**
- C** **S**
- D** **T**

TURN OVER FOR THE NEXT QUESTION

Turn over ►

QUESTION NINE

The drawing shows a section through part of a leaf.

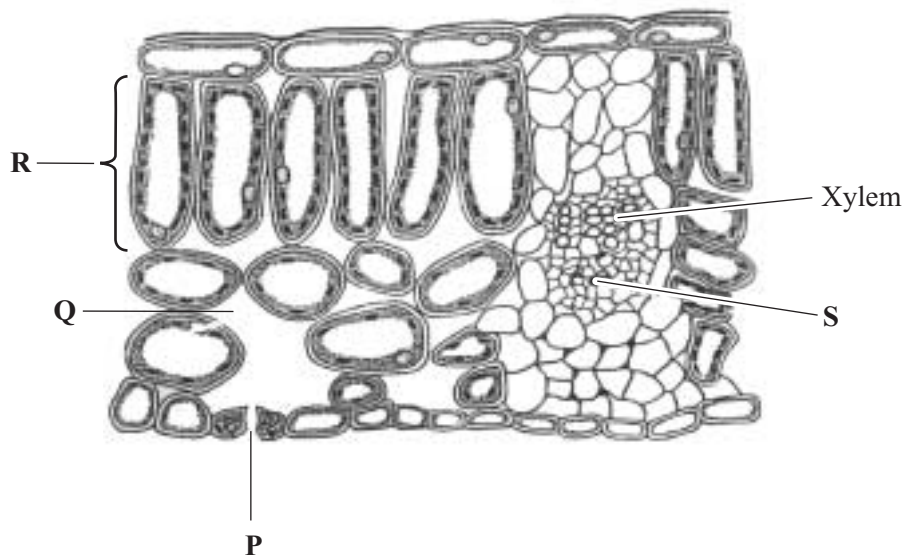

9.1 During photosynthesis, carbon dioxide moves from **P** to **Q** because

- A it is warmer inside the leaf.
- B the chloroplasts are giving out oxygen.
- C there is a higher concentration of carbon dioxide at **P** than at **Q**.
- D water vapour is moving out from **Q** to **P**.

9.2 Most photosynthesis takes place in region **R** because these cells

- A are close to the source of water.
- B are nearest to the supply of carbon dioxide.
- C are the largest.
- D contain most chlorophyll.

9.3 Sugar produced by photosynthesis can be stored in the leaf as

- A** glucagon.
- B** glucose.
- C** nitrates.
- D** starch.

9.4 The cells labelled **S** carry

- A** starch to the leaf.
- B** sugar to the roots.
- C** water to the growing regions.
- D** water to the leaf cells.

TURN OVER FOR THE NEXT QUESTION

Turn over ►

QUESTION TEN

A freshly cut shoot was placed in a tube containing water, as shown in **Figure 1**. The surface of the water was covered in a layer of oil. The mass of the apparatus was recorded at intervals for 200 minutes.

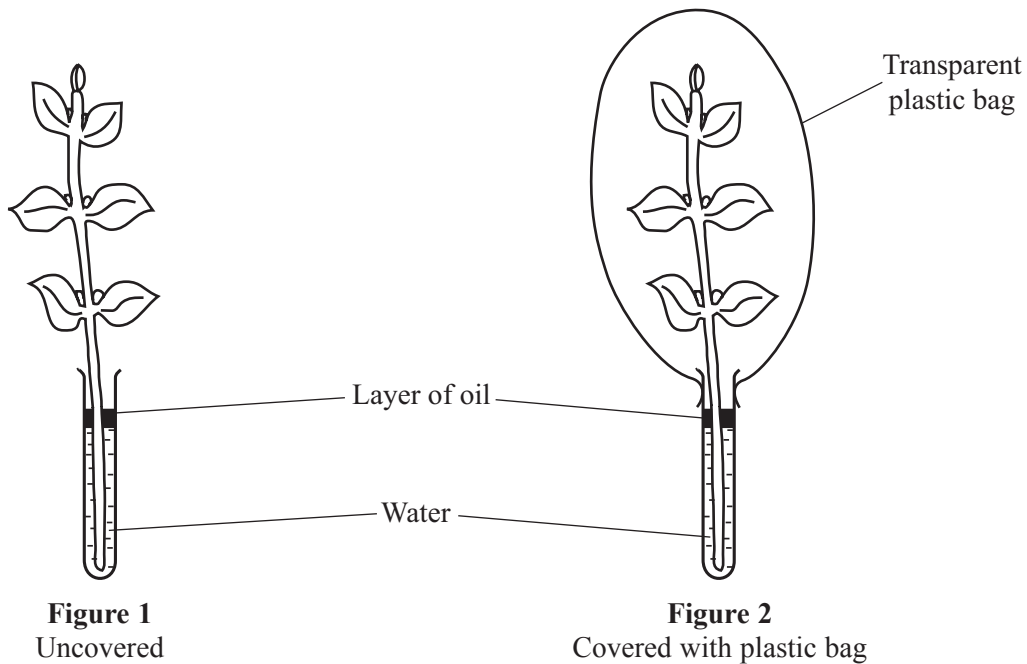

The apparatus was then placed in a transparent plastic bag, as shown in **Figure 2**. The mass of the apparatus was again recorded for the same length of time. During both investigations the apparatus was kept in bright light at 15°C.

The graph shows the results of the investigation when the shoot was uncovered.

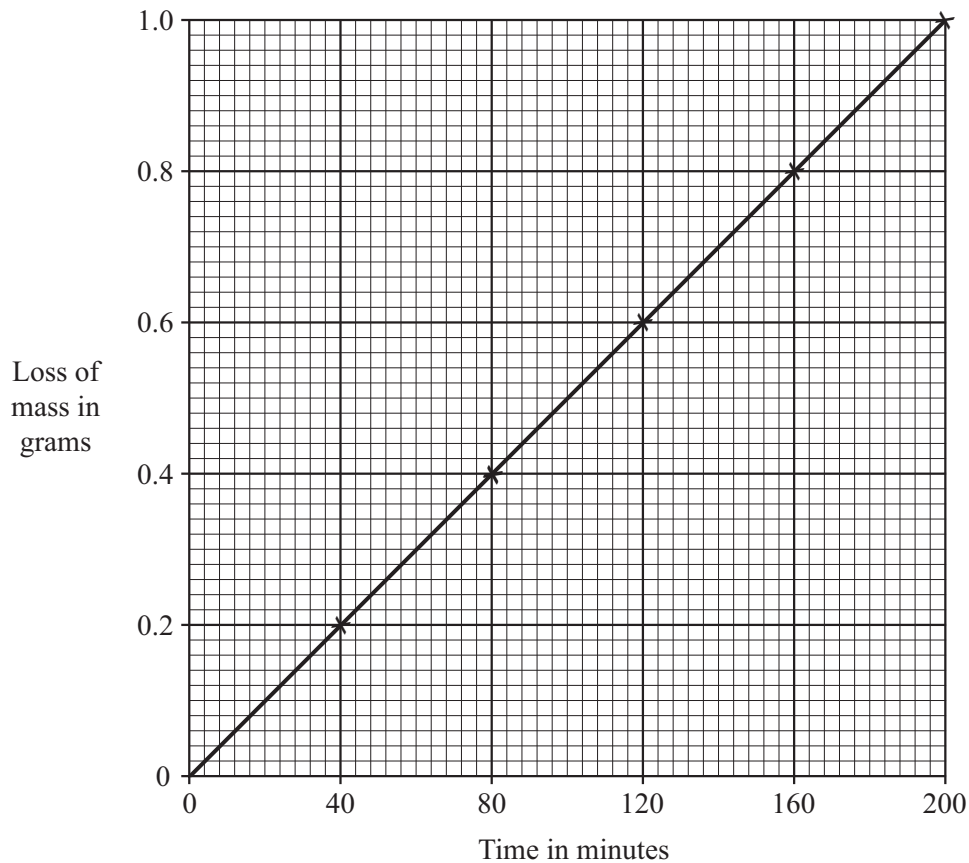

- 10.1** The rate of water loss from the uncovered shoot was
- A** 0.15 g per hour.
 - B** 0.3 g per hour.
 - C** 0.75 g per hour.
 - D** 200 g per hour.
- 10.2** There was no loss in mass from the covered shoot. This is probably because
- A** no more water was left in the tube.
 - B** no water vapour could escape from the apparatus.
 - C** the carbon dioxide concentration had increased.
 - D** the shoot had stopped photosynthesising.
- 10.3** Most water vapour is lost from plant leaves through the
- A** phloem tissue.
 - B** stomata.
 - C** waxy cuticle.
 - D** xylem tissue.
- 10.4** The loss of water vapour from plant leaves is called
- A** diffusion.
 - B** osmosis.
 - C** transpiration.
 - D** wilting.

END OF TEST

You must do **one Tier** only, **either** the Foundation Tier **or** the Higher Tier.
The Foundation Tier is earlier in this booklet.

HIGHER TIER

SECTION A

Questions **ONE** and **TWO**.

In these questions match the words in the list with the numbers.

Use **each** answer only **once**.

Mark your choices on the answer sheet.

QUESTION ONE

The diagram shows a plant cell.

Match words from the list with each of the labels **1–4** on the diagram.

contains a green substance

controls movement in and out of the cell

controls the activities of the cell

water in here supports young plants

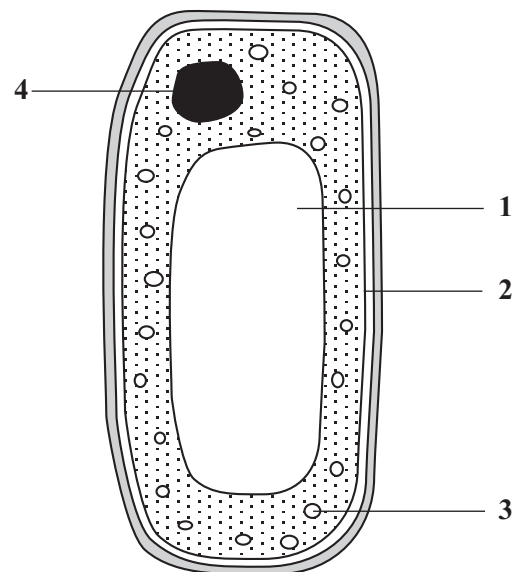

QUESTION TWO

The table is about the effects some chemicals have on the body.

Match words from the list with each of the numbers 1–4 in the table.

alcohol

carbon monoxide

nicotine

a solvent

Chemical	Effect on body
1	affects behaviour when inhaled
2	combines irreversibly with haemoglobin
3	makes it difficult to give up smoking
4	slows down the transmission of nerve impulses

TURN OVER FOR THE NEXT QUESTION

Turn over ►

SECTION BQuestions **THREE** and **FOUR**.In these questions choose the best **two** answers.Do **not** choose more than two.Mark your choices on the answer sheet.

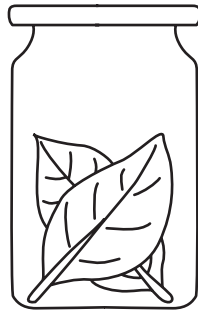
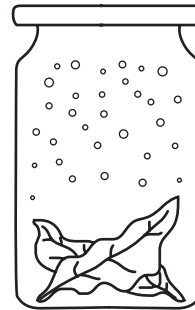
QUESTION THREE**Figure 1** shows a glass jar with an airtight lid containing freshly picked leaves.**Figure 2** shows the same jar after two hours. The inside of the jar is now covered with small drops of water.**Figure 1****Figure 2**Which **two** of the following does this experiment show?**the leaves had no cuticle****the leaves had photosynthesised****the leaves had respired****the leaves had transpired****the leaves had wilted**

QUESTION FOUR

Body temperature is controlled by the brain.

Which **two** of the following contain receptors involved in temperature control?

pancreas

pituitary gland

skin

sweat glands

thermoregulatory centre

TURN OVER FOR THE NEXT QUESTION

SECTION CQuestions **FIVE** to **TEN**.

Each of these questions has four parts.

In each part choose only **one** answer.Mark your choices on the answer sheet.

QUESTION FIVE

The diagram shows a section through the eye of a frog.

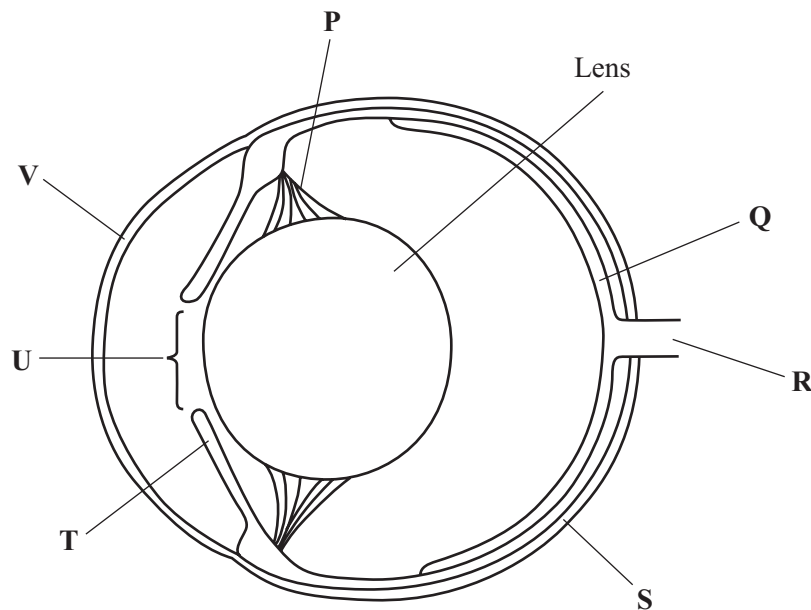

5.1 Which part of the eye is most likely to be the cornea?

- A Q
- B R
- C S
- D V

5.2 Which part is most likely to be the iris?

- A S
- B T
- C U
- D V

5.3 Structure **P** is most likely to be a

- A** ciliary muscle.
- B** pupil.
- C** retina.
- D** suspensory ligament.

5.4 Receptor cells sensitive to light are most likely to be found in

- A** **Q**
- B** **R**
- C** **S**
- D** **T**

TURN OVER FOR THE NEXT QUESTION

Turn over ▶

QUESTION SIX

The drawing shows a section through part of a leaf.

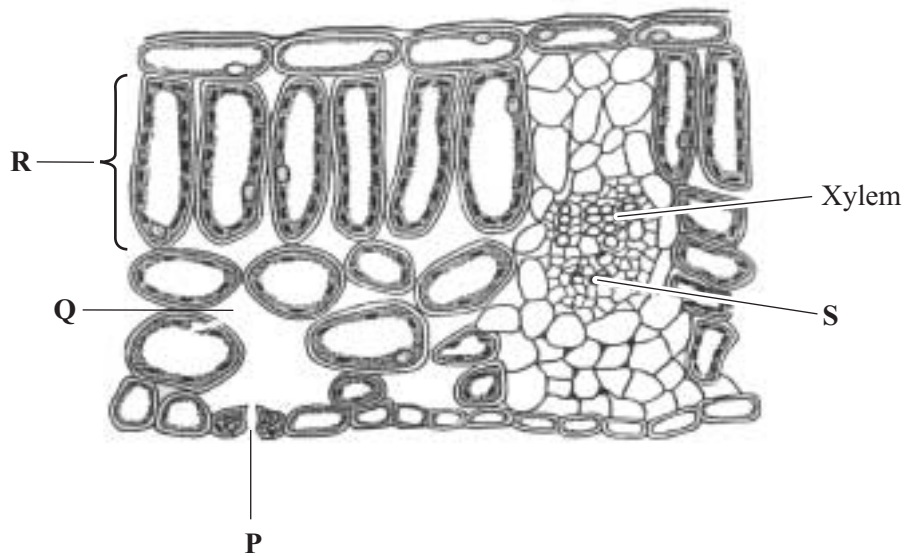

6.1 During photosynthesis, carbon dioxide moves from **P** to **Q** because

- A it is warmer inside the leaf.
- B the chloroplasts are giving out oxygen.
- C there is a higher concentration of carbon dioxide at **P** than at **Q**.
- D water vapour is moving out from **Q** to **P**.

6.2 Most photosynthesis takes place in region **R** because these cells

- A are close to the source of water.
- B are nearest to the supply of carbon dioxide.
- C are the largest.
- D contain most chlorophyll.

6.3 Sugar produced by photosynthesis can be stored in the leaf as

- A** glucagon.
- B** glucose.
- C** nitrates.
- D** starch.

6.4 The cells labelled **S** carry

- A** starch to the leaf.
- B** sugar to the roots.
- C** water to the growing regions.
- D** water to the leaf cells.

TURN OVER FOR THE NEXT QUESTION

Turn over ►

QUESTION SEVEN

A freshly cut shoot was placed in a tube containing water, as shown in **Figure 1**. The surface of the water was covered in a layer of oil. The mass of the apparatus was recorded at intervals for 200 minutes.

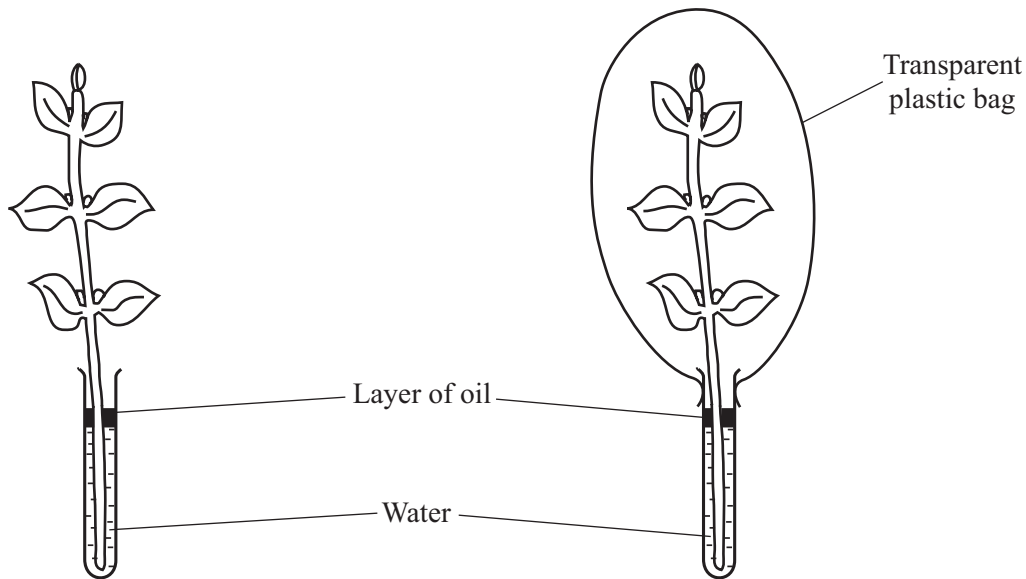
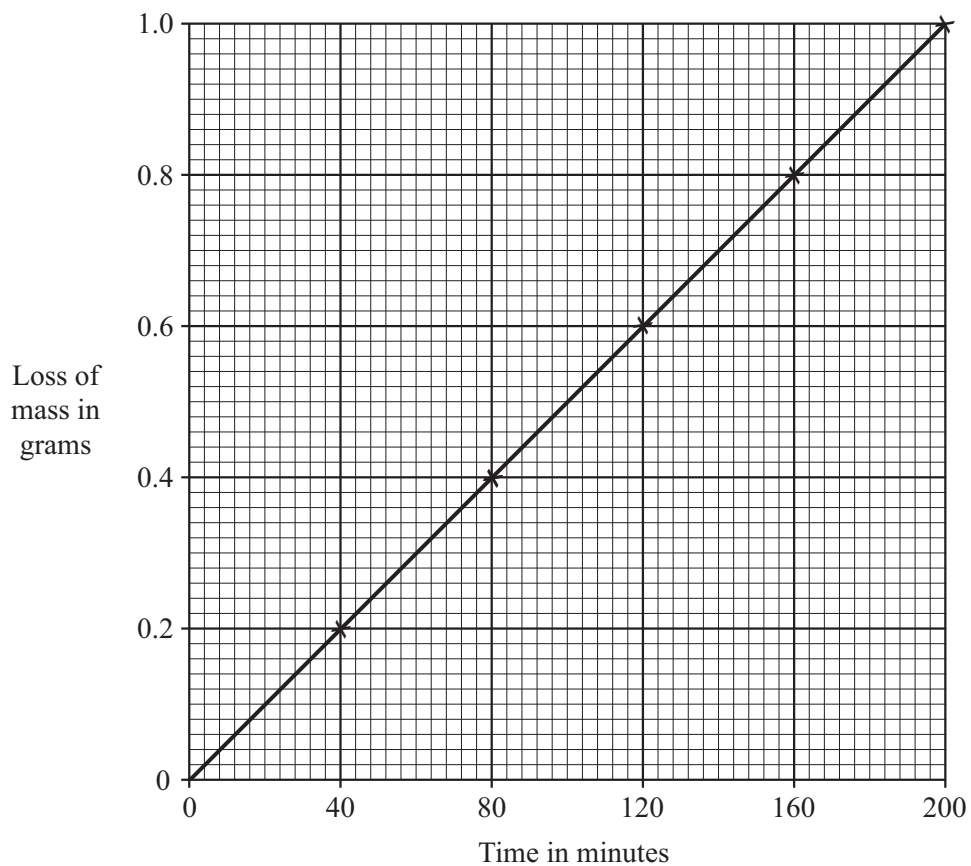

Figure 1
Uncovered

Figure 2
Covered with plastic bag

The apparatus was then placed in a transparent plastic bag, as shown in **Figure 2**. The mass of the apparatus was again recorded for the same length of time. During both investigations the apparatus was kept in bright light at 15°C.

The graph shows the results of the investigation when the shoot was uncovered.



-
- 7.1** The rate of water loss from the uncovered shoot was
- A** 0.15 g per hour.
 - B** 0.3 g per hour.
 - C** 0.75 g per hour.
 - D** 200 g per hour.
- 7.2** There was no loss in mass from the covered shoot. This is probably because
- A** no more water was left in the tube.
 - B** no water vapour could escape from the apparatus.
 - C** the carbon dioxide concentration had increased.
 - D** the shoot had stopped photosynthesising.
- 7.3** Most water vapour is lost from plant leaves through the
- A** phloem tissue.
 - B** stomata.
 - C** waxy cuticle.
 - D** xylem tissue.
- 7.4** The loss of water vapour from plant leaves is called
- A** diffusion.
 - B** osmosis.
 - C** transpiration.
 - D** wilting.

QUESTION EIGHT

The kidney helps to maintain the body's internal environment.

8.1 Which of the following is **not** reabsorbed in the kidney?

- A Glucose
- B Mineral ions
- C Urea
- D Water

8.2 ADH is produced by the

- A kidney.
- B liver.
- C pancreas.
- D pituitary gland.

8.3 ADH is produced when

- A the blood sugar level is too low.
- B the core temperature is too high.
- C the urea content of the blood is too high.
- D the water content of the blood is too low.

8.4 A rise in the level of ADH will result in

- A the concentration of urine increasing.
- B the kidneys filtering more blood.
- C the liver producing more urea.
- D the volume of urine increasing.

QUESTION NINE

Reflex actions are involved in some of the body's responses.

9.1 Which of the following describes the path taken by an impulse in a reflex action?

- A effector → sensory neurone → relay neurone → motor neurone
- B receptor → sensory neurone → relay neurone → motor neurone
- C sensory neurone → motor neurone → relay neurone → synapse
- D synapse → receptor → relay neurone → sensory neurone

9.2 The function of a synapse is to

- A detect changes in temperature.
- B produce nerve impulses in a receptor.
- C stimulate a gland.
- D transfer an impulse from one neurone to another.

9.3 Which of the following is true of motor neurones?

- A They begin in receptors
- B They occur only in the spinal cord
- C They transmit impulses to muscles
- D They transmit impulses to the brain

9.4 Which of the following is true of reflex actions?

- A The brain always coordinates the responses
- B They all involve the spinal cord
- C They are all triggered by external stimuli
- D They are always automatic

Turn over ►

QUESTION TEN

Water is lost from the body in several ways.

The volume of water lost varies with the activity of the person.

The table shows the water loss from the body of an athlete when he is 'not in training' and when he is 'in training'.

Source of water loss	Water loss in cm ³ per day	
	when not in training	when in training
Urine	1400	500
Skin	500	5300
Faeces	200	200
Lungs	400	550

10.1 The increase in water loss per day as a result of training is

- A 2500 cm³
- B 4050 cm³
- C 4500 cm³
- D 6550 cm³

10.2 The proportion of water lost via the athlete's skin when he is not in training is

- A $\frac{1}{53}$ (1.89%)
- B $\frac{1}{50}$ (2%)
- C $\frac{1}{25}$ (4%)
- D $\frac{1}{5}$ (20%)

10.3 More water is lost from the athlete's skin when he is in training because this

- A ensures that salt is released onto the skin.
- B helps to maintain the correct working temperature for enzymes.
- C prevents too much blood from entering the capillaries of the skin.
- D removes excess water from the body.

- 10.4** The reduction in urine volume when he is in training is most likely to be because
- A** faeces are moving faster through the digestive system.
 - B** more urea is produced during exercise.
 - C** the blood plasma of the athlete is more dilute.
 - D** the water lost through the skin has not been replaced quickly enough.

END OF TEST