

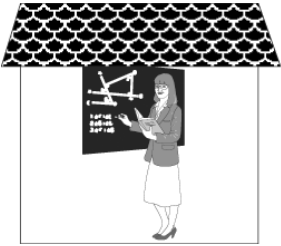



Leave blank

В городе

Пример: Куда он хочет пойти? Поставь крестик (☒)

A 	Б 	В 
<input checked="" type="checkbox"/>	<input type="checkbox"/>	<input type="checkbox"/>

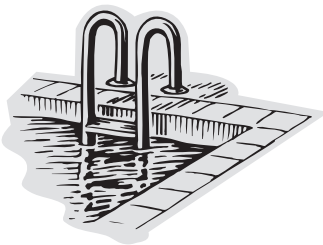
1. Куда он хочет пойти? Поставь крестик (☒)

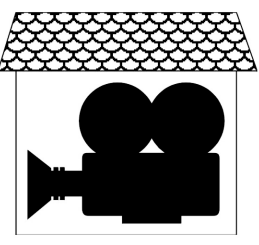
A 	Б 	В 
<input type="checkbox"/>	<input type="checkbox"/>	<input type="checkbox"/>

Q1

(Total 1 mark)

2. Куда она хочет пойти? Поставь крестик (☒)

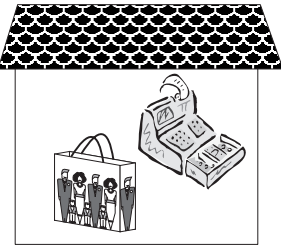
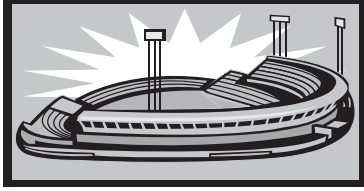
A 	Б 	В 
<input type="checkbox"/>	<input type="checkbox"/>	<input type="checkbox"/>



Q2

(Total 1 mark)



Leave blank

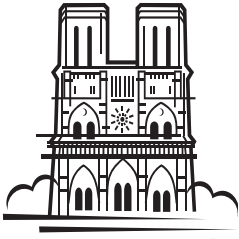

3. Куда он хочет пойти? Поставь крестик (☒)

A 	Б 	В 
<input type="checkbox"/>	<input type="checkbox"/>	<input type="checkbox"/>

(Total 1 mark)

Q3



4. Куда она хочет пойти? Поставь крестик (☒)

A 	Б 	В 
<input type="checkbox"/>	<input type="checkbox"/>	<input type="checkbox"/>

(Total 1 mark)

Q4

5. Куда он хочет пойти? Поставь крестик (☒)

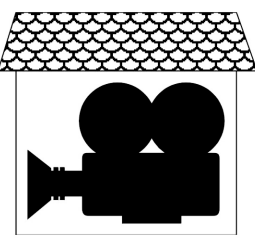
A 	Б 	В 
<input type="checkbox"/>	<input type="checkbox"/>	<input type="checkbox"/>

(Total 1 mark)







Q5



Leave blank

Школа

Кто что любит? Поставь крестик (☒)

	А	Б	В	Г	Д	Е	Ж
							
Пример: Анна	<input type="checkbox"/>	<input type="checkbox"/>	<input type="checkbox"/>	<input type="checkbox"/>	<input type="checkbox"/>	<input type="checkbox"/>	<input checked="" type="checkbox"/>
6. Вова	<input type="checkbox"/>	<input type="checkbox"/>	<input type="checkbox"/>	<input type="checkbox"/>	<input type="checkbox"/>	<input type="checkbox"/>	<input type="checkbox"/>
7. Надя	<input type="checkbox"/>	<input type="checkbox"/>	<input type="checkbox"/>	<input type="checkbox"/>	<input type="checkbox"/>	<input type="checkbox"/>	<input type="checkbox"/>
8. Паша	<input type="checkbox"/>	<input type="checkbox"/>	<input type="checkbox"/>	<input type="checkbox"/>	<input type="checkbox"/>	<input type="checkbox"/>	<input type="checkbox"/>
9. Вика	<input type="checkbox"/>	<input type="checkbox"/>	<input type="checkbox"/>	<input type="checkbox"/>	<input type="checkbox"/>	<input type="checkbox"/>	<input type="checkbox"/>
10. Глеб	<input type="checkbox"/>	<input type="checkbox"/>	<input type="checkbox"/>	<input type="checkbox"/>	<input type="checkbox"/>	<input type="checkbox"/>	<input type="checkbox"/>

(Total 5 marks)

Q6-10



Leave
blank

Радио

11. По радио говорит футболист. Посмотри анкету и запиши информацию по-русски.

Пример: Фамилия **Лукин**

(i) Возраст лет

(ii) Дети

(iii) Хобби и

Q11

(Total 4 marks)

5

Turn over







Leave
blank

Идеальная квартира

12. Что Иван хочет в спальне? Поставь 3 крестика (☒)

Пример:

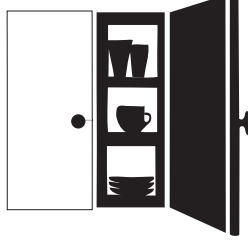

А 	Б 
<input checked="" type="checkbox"/>	<input checked="" type="checkbox"/>
В 	Г 
<input checked="" type="checkbox"/>	<input checked="" type="checkbox"/>

(Total 3 marks)

Q12



Leave
blank

Мой город

13. Кто что думает? Поставь 4 крестика (☒)

- А Можно всегда делать покупки
- Б Это исторический город
- В Культурная жизнь не интересует его/её
- Г Город ему/ей не очень нравится
- Д Всё в городе стоит дорого
- Е Это самый красивый город в России

	А	Б	В	Г	Д	Е
Пример: Николай	<input checked="" type="checkbox"/>	<input checked="" type="checkbox"/>	<input checked="" type="checkbox"/>	<input checked="" type="checkbox"/>	<input checked="" type="checkbox"/>	<input checked="" type="checkbox"/>
(i) Лена	<input type="checkbox"/>	<input type="checkbox"/>	<input type="checkbox"/>	<input type="checkbox"/>	<input type="checkbox"/>	<input type="checkbox"/>
(ii) Вадим	<input type="checkbox"/>	<input type="checkbox"/>	<input type="checkbox"/>	<input type="checkbox"/>	<input type="checkbox"/>	<input type="checkbox"/>
(iii) Юля	<input type="checkbox"/>	<input type="checkbox"/>	<input type="checkbox"/>	<input type="checkbox"/>	<input type="checkbox"/>	<input type="checkbox"/>
(iv) Никита	<input type="checkbox"/>	<input type="checkbox"/>	<input type="checkbox"/>	<input type="checkbox"/>	<input type="checkbox"/>	<input type="checkbox"/>

(Total 4 marks)

Q13

7

Turn over



N 2 7 9 6 6 A 0 7 1 6

Leave blank

Музыка

14. На чём играет Наташа? Напиши 2 буквы

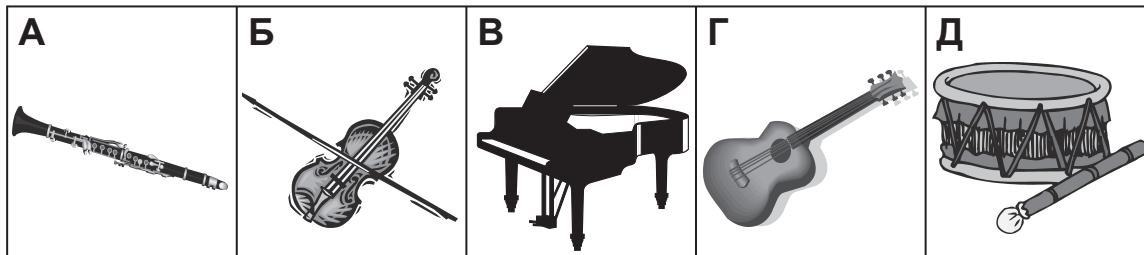





Пример:	А
(i)	
(ii)	

Q14

(Total 2 marks)

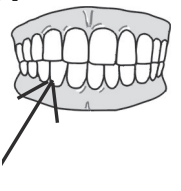
Школа

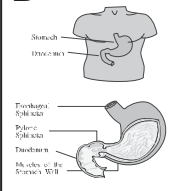
15. Почему ученики не в школе? Поставь 3 крестика (☒)

	А 	Б 	В 	Г 	Д 
Пример: Антон	<input type="checkbox"/>	<input type="checkbox"/>	<input type="checkbox"/>	<input type="checkbox"/>	<input checked="" type="checkbox"/>
(i) Валя	<input type="checkbox"/>	<input type="checkbox"/>	<input type="checkbox"/>	<input type="checkbox"/>	<input type="checkbox"/>
(ii) Серёжа	<input type="checkbox"/>	<input type="checkbox"/>	<input type="checkbox"/>	<input type="checkbox"/>	<input type="checkbox"/>
(iii) Анна	<input type="checkbox"/>	<input type="checkbox"/>	<input type="checkbox"/>	<input type="checkbox"/>	<input type="checkbox"/>

Q15

(Total 3 marks)



Leave
blank

В бюро находок

16. А. Выбери правильные ответы. Поставь 4 крестика (☒)

Пример:	Мужчину зовут Степан	<input checked="" type="checkbox"/>
(i)	У бабушки был праздник	<input checked="" type="checkbox"/>
(ii)	Степан ушёл после десяти часов вечера	<input checked="" type="checkbox"/>
(iii)	У Степана в пятницу был свободный день	<input checked="" type="checkbox"/>
(iv)	Он поехал домой на поезде	<input checked="" type="checkbox"/>
(v)	Он быстро купил билет	<input checked="" type="checkbox"/>
(vi)	Бумажник был подарок	<input checked="" type="checkbox"/>
(vii)	У Степана друг англичанин	<input checked="" type="checkbox"/>
(viii)	Степан потерял много денег	<input checked="" type="checkbox"/>

Б. Выбери правильные ответы. Поставь 2 крестика (☒)

(i)	Степану было грустно	<input checked="" type="checkbox"/>
(ii)	Степану было скучно	<input checked="" type="checkbox"/>
(iii)	Степан был в панике	<input checked="" type="checkbox"/>
(iv)	Степан был в хорошем настроении	<input checked="" type="checkbox"/>

Q16

(Total 6 marks)





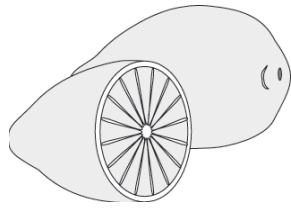

На рынке

17. Что покупает Катя? Поставь 3 крестика (☒)

Пример:

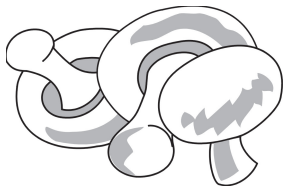
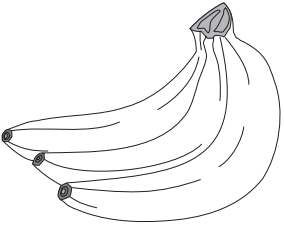

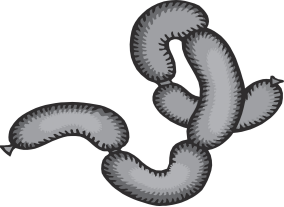
☒

А 	Б 	В 
<input type="checkbox"/>	<input type="checkbox"/>	<input type="checkbox"/>
Г 	Д 	Е 
<input type="checkbox"/>	<input type="checkbox"/>	<input type="checkbox"/>

(Total 3 marks)

Q17



Работа

18. Студентка говорит о своей работе. Что правильно? Поставь крестики (☒)

Пример: Как её зовут?

А	Нина	<input checked="" type="checkbox"/>
Б	Вера	<input checked="" type="checkbox"/>
В	Рита	<input checked="" type="checkbox"/>

(i) Где она работает?

А	в больнице	<input checked="" type="checkbox"/>
Б	в магазине	<input checked="" type="checkbox"/>
В	в школе	<input checked="" type="checkbox"/>

(ii) Сколько лет она работает там?

А	5 лет	<input checked="" type="checkbox"/>
Б	6 лет	<input checked="" type="checkbox"/>
В	7 лет	<input checked="" type="checkbox"/>

(iii) Нина всегда работает

А	по понедельникам	<input checked="" type="checkbox"/>
Б	по средам	<input checked="" type="checkbox"/>
В	по субботам	<input checked="" type="checkbox"/>

(iv) Нина продаёт

А	продукты	<input checked="" type="checkbox"/>
Б	мебель	<input checked="" type="checkbox"/>
В	сувениры	<input checked="" type="checkbox"/>

(v) Нина хочет стать

А	экскурсоводом	<input checked="" type="checkbox"/>
Б	медсестрой	<input checked="" type="checkbox"/>
В	механиком	<input checked="" type="checkbox"/>

Q18

(Total 5 marks)



Answer these questions **in English**

MARIA SHARAPOVA



19. Listen to this extract about the tennis player Maria Sharapova:

- (a) According to the extract, where in Siberia is Sharapova's home town?

..... (1)

- (b) How old was she when she started to play tennis?

..... (1)

- (c) What does her first coach say about her attitude during the 3 years they worked together?

.....
..... (2)

- (d) What did Martina Navratilova advise Maria's father to do?

.....
..... (2)



<p>(e) Name 2 things Maria likes to do in her spare time.</p> <p>.....</p> <p>.....</p> <p style="text-align: right;">(2)</p>	<p>Leave blank</p>
<p>(f) Why can Maria describe herself as patriotic?</p> <p>.....</p> <p>.....</p> <p style="text-align: right;">(2)</p>	
<p>(Total 10 marks)</p>	
<p>TOTAL FOR PAPER: 50 MARKS</p>	
<p>END</p>	



BLANK PAGE



BLANK PAGE



BLANK PAGE

