

Candidate Forename		Candidate Surname	
-------------------------------	--	------------------------------	--

Centre Number						Candidate Number				
--------------------------	--	--	--	--	--	-----------------------------	--	--	--	--

**OXFORD CAMBRIDGE AND RSA EXAMINATIONS
GENERAL CERTIFICATE OF SECONDARY EDUCATION**

A332/01

TWENTY FIRST CENTURY SCIENCE

PHYSICS A

**Unit 2 Modules P4 P5 P6
(Foundation Tier)**

MONDAY 1 FEBRUARY 2010: Afternoon

DURATION: 40 minutes

SUITABLE FOR VISUALLY IMPAIRED CANDIDATES

**Candidates answer on the Question Paper
A calculator may be used for this paper**

OCR SUPPLIED MATERIALS:

None

OTHER MATERIALS REQUIRED:

Pencil

Ruler (cm/mm)

READ INSTRUCTIONS OVERLEAF

INSTRUCTIONS TO CANDIDATES

- **Write your name clearly in capital letters, your Centre Number and Candidate Number in the boxes on the first page.**
- **Use black ink. Pencil may be used for graphs and diagrams only.**
- **Read each question carefully and make sure that you know what you have to do before starting your answer.**
- **Answer ALL the questions.**
- **Write your answer to each question in the space provided, however additional paper may be used if necessary.**

INFORMATION FOR CANDIDATES

- **The number of marks is given in brackets [] at the end of each question or part question.**
- **A list of physics equations is printed on pages 4–5.**
- **The total number of marks for this paper is 42.**

BLANK PAGE

TWENTY FIRST CENTURY SCIENCE EQUATIONS USEFUL RELATIONSHIPS

EXPLAINING MOTION

- **speed = $\frac{\text{distance travelled}}{\text{time taken}}$**
- **momentum = mass \times velocity**
- **change of momentum = resultant force \times time for which it acts**
- **work done by a force = force \times distance moved by the force**
- **change in energy = work done**
- **change in GPE = weight \times vertical height difference**
- **kinetic energy = $\frac{1}{2} \times \text{mass} \times [\text{velocity}]^2$**

ELECTRIC CIRCUITS

- **resistance = $\frac{\text{voltage}}{\text{current}}$**
- **$\frac{\text{voltage across primary coil}}{\text{voltage across secondary coil}}$**
= $\frac{\text{number of turns in primary coil}}{\text{number of turns in secondary coil}}$
- **energy transferred = power × time**
- **power = potential difference × current**
- **efficiency = $\frac{\text{energy usefully transferred}}{\text{total energy supplied}} \times 100\%$**

THE WAVE MODEL OF RADIATION

- **wave speed = frequency × wavelength**

Answer ALL the questions.

1 This question is about different journeys made by a lorry.

(a) On its first journey the lorry is travelling along a straight road.

The lorry travels 6 km and then turns around and travels 3.6 km back.

(i) What is the total distance travelled by the lorry?

_____ km [1]

(ii) How far is the lorry from its starting point?

_____ km [1]

(b) On its second journey the lorry started from its depot.

A distance–time graph for this journey is shown below.

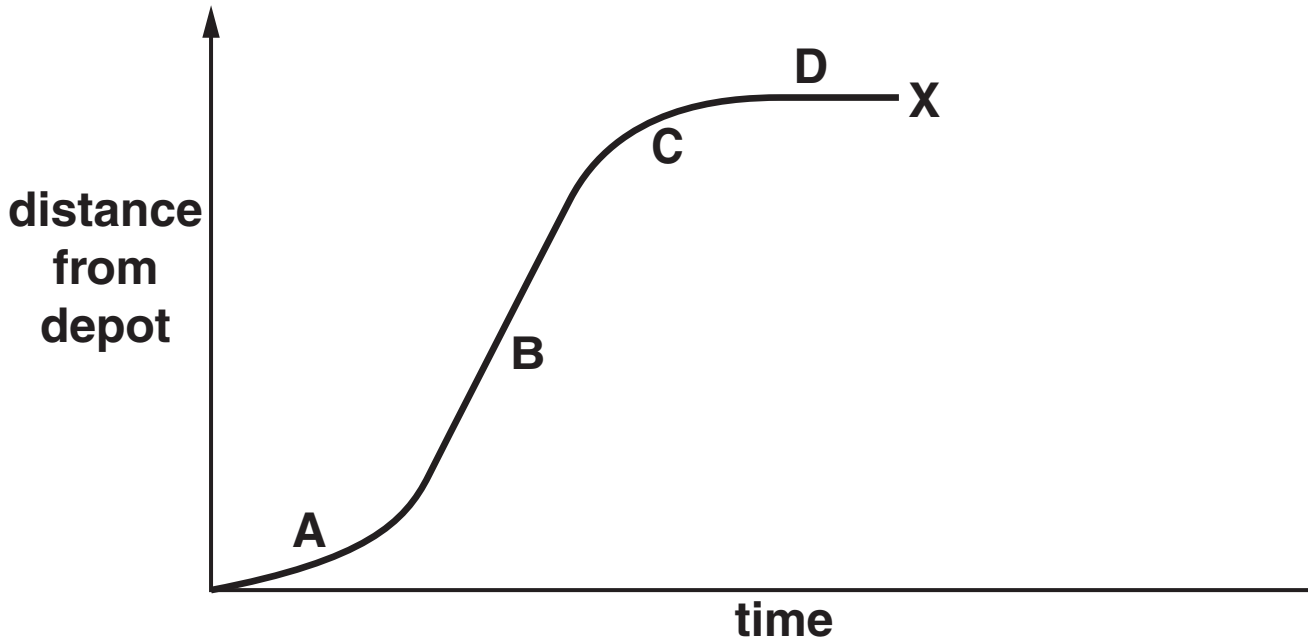

(i) Write the correct letter, A, B, C or D, in each box to show when...

...the lorry is travelling fastest.

...the lorry is stationary.

[2]

(ii) Continue the line from X to show the lorry returning to its depot.

[1]

(c) A tachograph is a graph that shows how a vehicle's speed changes during a journey.

On its third journey part of the lorry's tachograph looks like this. The letters A, B, C and D label different parts of the journey.

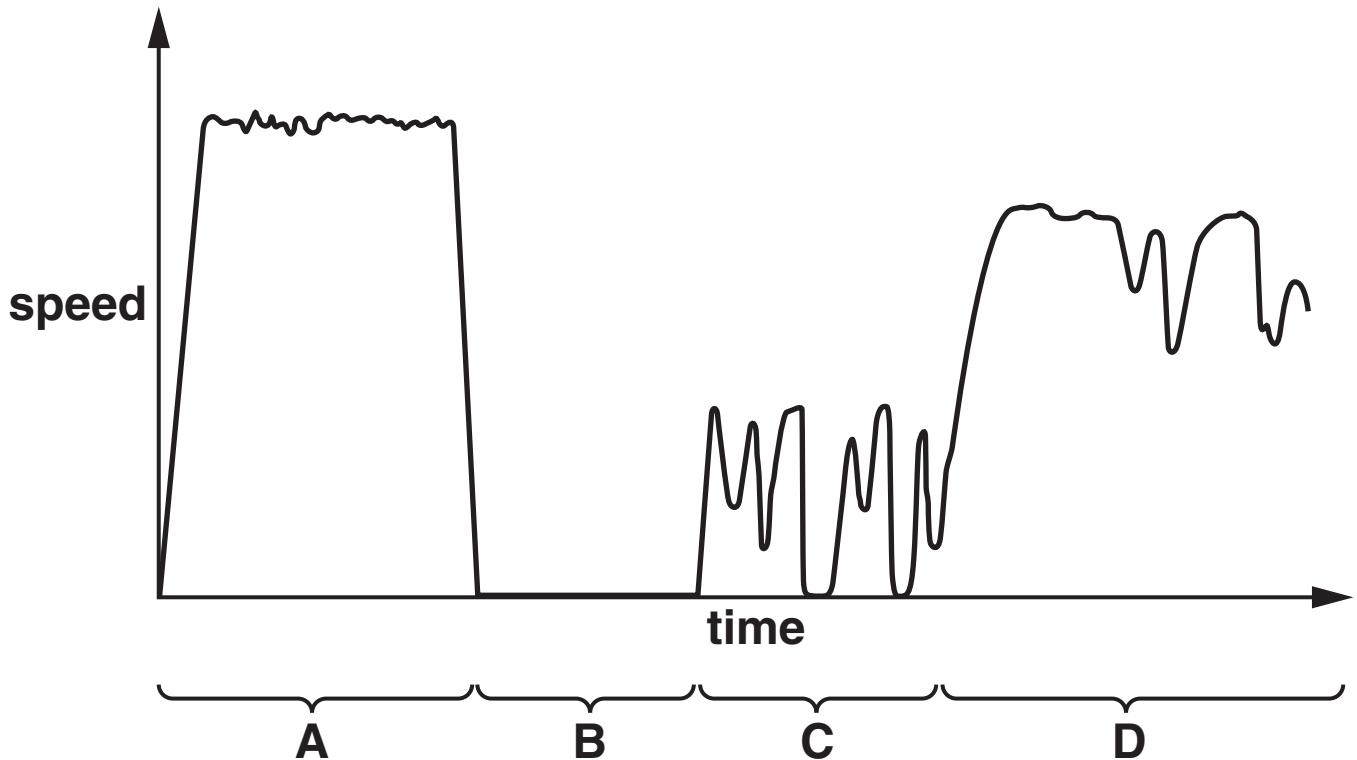

From the tachograph we can tell what is happening in each part of the journey.

A shows the lorry driving along a motorway.

B shows a rest period.

C shows the lorry driving through a town.

D shows the lorry driving along a busy main road.

Part B was a rest period because the tachograph shows that the lorry was not moving.

Explain how the tachograph shows what is happening during A, C and D.

[3]

[Total: 8]

2 This question is about work done and energy transfers.

(a) Buzz is an astronaut. He is floating in space far away from the Sun or any planets.

He uses small rocket boosters on his space pack to MOVE about.

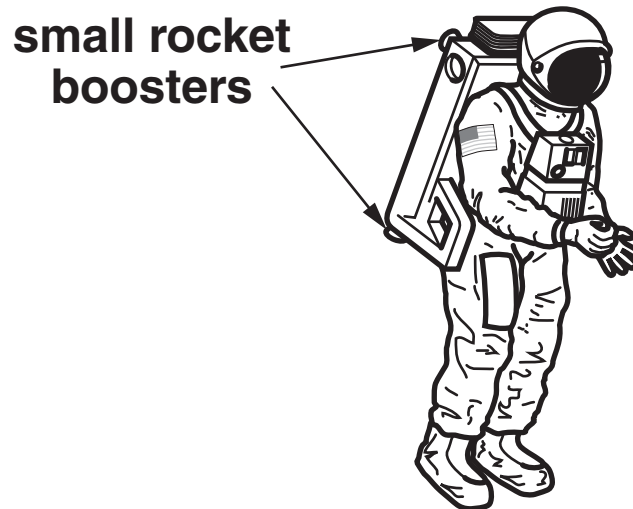

Complete the sentences.

Choose words from this list.

CHARGE

FORCE

KINETIC ENERGY

POTENTIAL ENERGY

WORK

The rocket boosters exert a

_____ on the astronaut.

The astronaut speeds up. This means the boosters must be doing _____ .

This is equal to the _____ gained by the astronaut. [3]

(b) Buzz's spacecraft re-enters the Earth's atmosphere.

The spacecraft has a gravitational potential energy of 8 MJ on re-entry.

(i) What is the maximum possible increase in the kinetic energy of the spacecraft as it falls?

_____ MJ [1]

(ii) Explain WHY the actual increase in kinetic energy of the spacecraft will be less than your answer in part (i).

_____ [2]

[Total: 6]

3 John is cleaning his television.

(a) The television casing becomes charged when it is rubbed with a duster.

This is because electrons are transferred FROM the duster TO the casing.

Complete the following sentence using one of the words in this list.

POSITIVE

NEUTRAL

NEGATIVE

An electron carries a _____ charge.

[1]

(b) Inside the television set there are lots of different circuits.

(i) Three of these circuits are drawn opposite.

The voltage across each circuit is the same.

circuit A

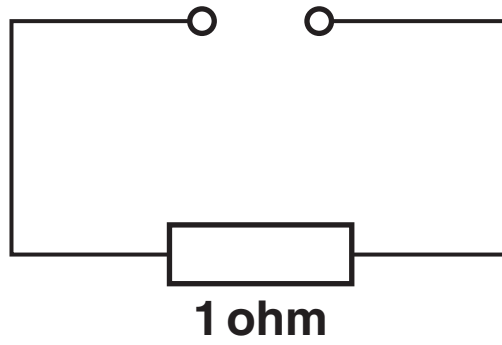

circuit B

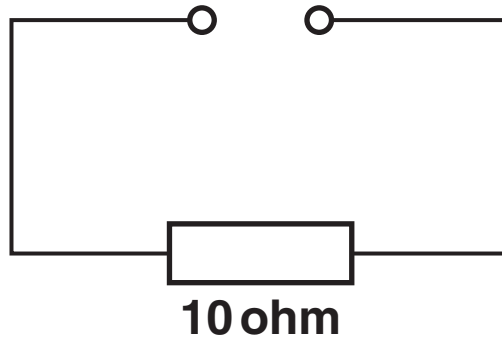

circuit C

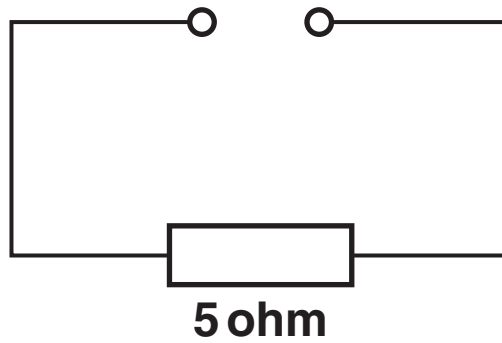

Put these circuits in order of the size of their current. Write the correct letter, A, B or C, in each box.

smallest

--	--	--

 largest

[1]

(ii) Fred is a television repair man.

He adds an extra 5 ohm resistor to circuit C.

He puts it in series.

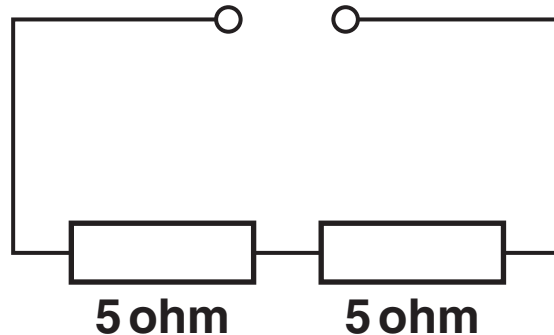

What happens to the resistance of the circuit?

Put a **ring** around the correct answer.

INCREASES

STAYS THE SAME

DECREASES

[1]

(iii) Fred now puts the extra resistor in parallel.

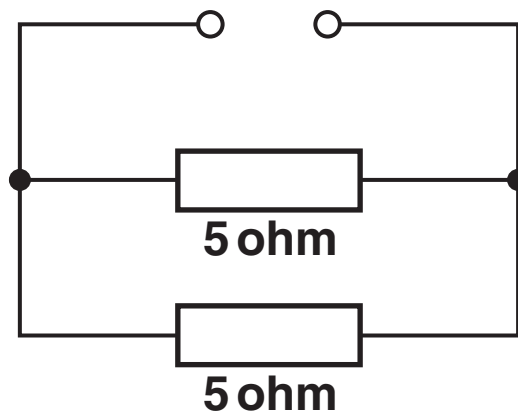

What happens to the resistance of the circuit?

Put a **ring** around the correct answer.

INCREASES

STAYS THE SAME

DECREASES

[1]

(iv) All these resistors will heat up when the television is turned on.

Why does turning on the television cause the resistors to heat up?

_____ [1]

(v) Temperature can be detected with a thermistor.

How does the resistance of a thermistor change with temperature?

_____ [1]

(c) John's television has a power rating of 500 watts.

He uses it for 4 hours every day.

The cost of electricity is 8 pence per kWh.

How much does his television cost to run in pence per day?

Put a **ring** around the correct calculation.

$$500 \times 4 \times 8\text{p}$$

$$\frac{500}{1000} \times 4 \times 8\text{p}$$

$$500 \times 4\text{p}$$

$$\frac{500}{1000} \times 4 \times 60 \times 60 \times 8\text{p}$$

[1]

(d) Domestic electricity meters measure the electrical energy used in a house in kilowatt hours and not in joules.

Complete the following sentence using one of the words in this list.

SMALL

LARGE

USEFUL

WASTEFUL

This is because a joule is a very

_____ amount of energy
compared to a kilowatt hour.

[1]

[Total: 8]

4 Michael has a coil of wire and a magnet.

(a) He moves the magnet into the coil as shown below.

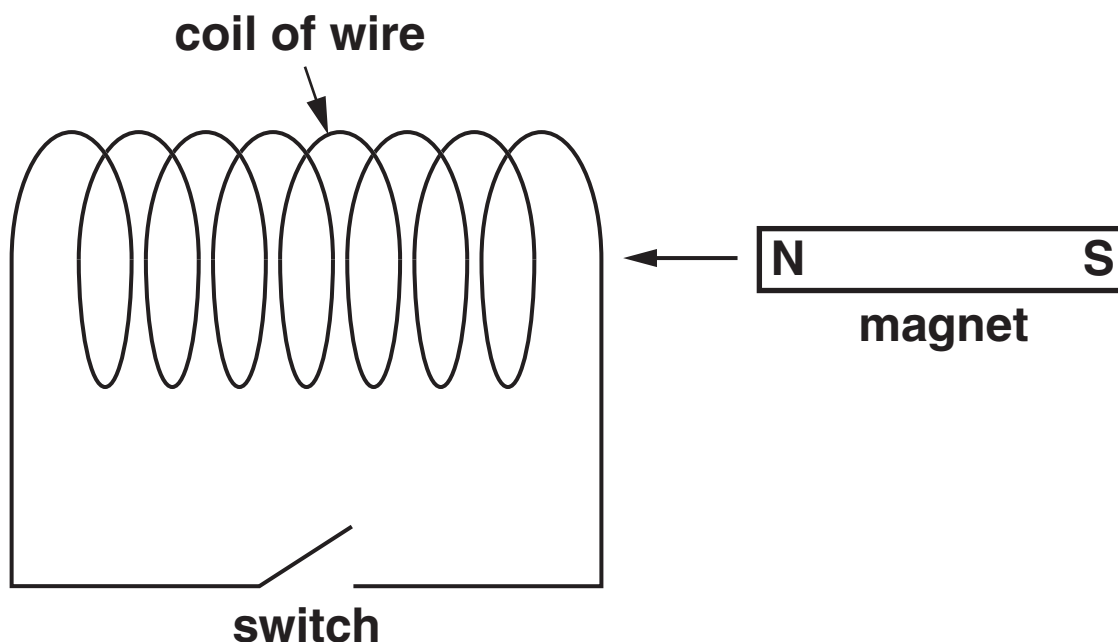

Put a **ring** around the correct words in each sentence.

Whenever the magnet moves then a VOLTAGE / POWER / CHARGE is induced across the coil.

If the switch is closed
THE RESISTANCE INCREASES /
A CURRENT FLOWS /
THE VOLTAGE INCREASES.

[2]

(b) The diagram shows a simple generator.

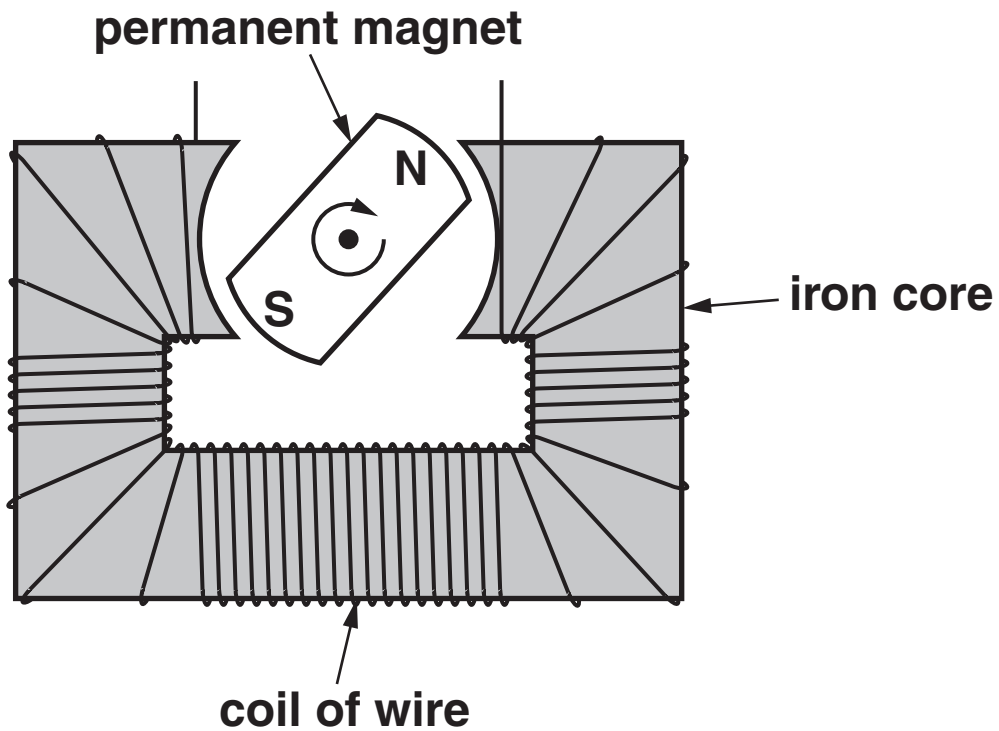

Describe how a simple generator produces electricity.

[2]

(c) Michael has an electric torch that uses a battery.

He also has a table lamp that uses mains electricity.

Complete the sentences using words from this list.

ALTERNATING

DIGITAL

DIRECT

2

110

230

In a torch the battery produces

_____ **current.**

The mains electricity in the table lamp is

_____ **current.**

The mains voltage supply to our homes is

_____ **volts.** **[3]**

[Total: 7]

5 This question is about the properties of waves.

(a) When we look at a rainbow we see the different colours of the spectrum.

Finish the sentence below by choosing the CORRECT word from this list.

WAVELENGTH

SPEED

AMPLITUDE

INTENSITY

Each colour of light always has a different

_____ .

[1]

(b) Put a ring around the type of wave which is not part of the electromagnetic spectrum.

RADIO WAVES

SOUND

VISIBLE LIGHT

X-RAYS

[1]

(c) Which of the following statements is true for all electromagnetic waves travelling through a vacuum?

Put a tick (✓) in the box next to the correct statement.

They all have the same wavelength.

They all have the same frequency.

They all have the same speed.

They all have the same amplitude.

[1]

(d) In an electromagnetic beam of radiation, the energy is carried by photons.

Here are four statements about photons. Some statements are correct, the others are not.

Put a tick (✓) in the box next to each of the TWO correct statements.

The greater the frequency of the radiation the lower the energy of its photons.

The intensity of a beam of light depends on the number of photons arriving per second.

Photons travel at the speed of light.

The greater the energy of the photon the faster it moves.

[2]

- (e) Different parts of the electromagnetic spectrum have different properties.

They can be used for different purposes.

Draw a straight line from each USE OF A WAVE to the PROPERTY that makes it suitable for the use.

USE OF A WAVE

Radio waves can be used to carry information over long distances ...

Some microwaves can be used to heat food ...

Infrared rays can be used to carry information along optical fibres ...

PROPERTY

... because they are absorbed by water molecules.

... because they are not absorbed by the atmosphere.

... because they can travel through glass without becoming significantly weaker.

[2]

- (f) When water waves travel from deep to shallow water they slow down.

This can cause a change in their direction.

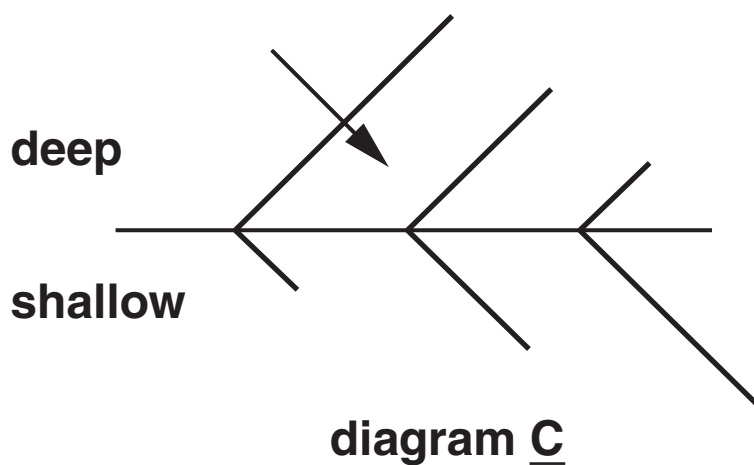
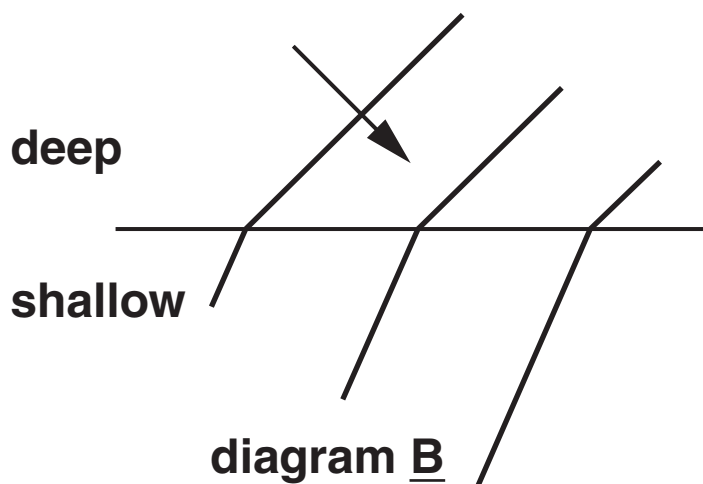
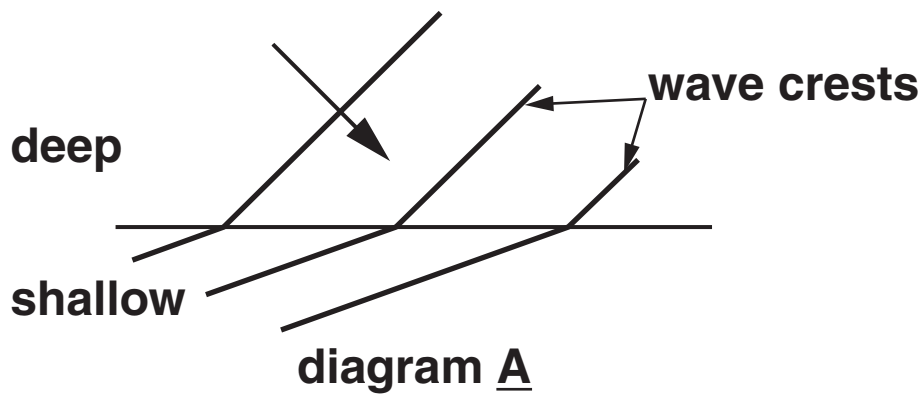

Which diagram, A, B, or C, correctly shows what happens? _____ [1]

[Total: 8]

6 The diagram below shows a very simplified model of a radio system.

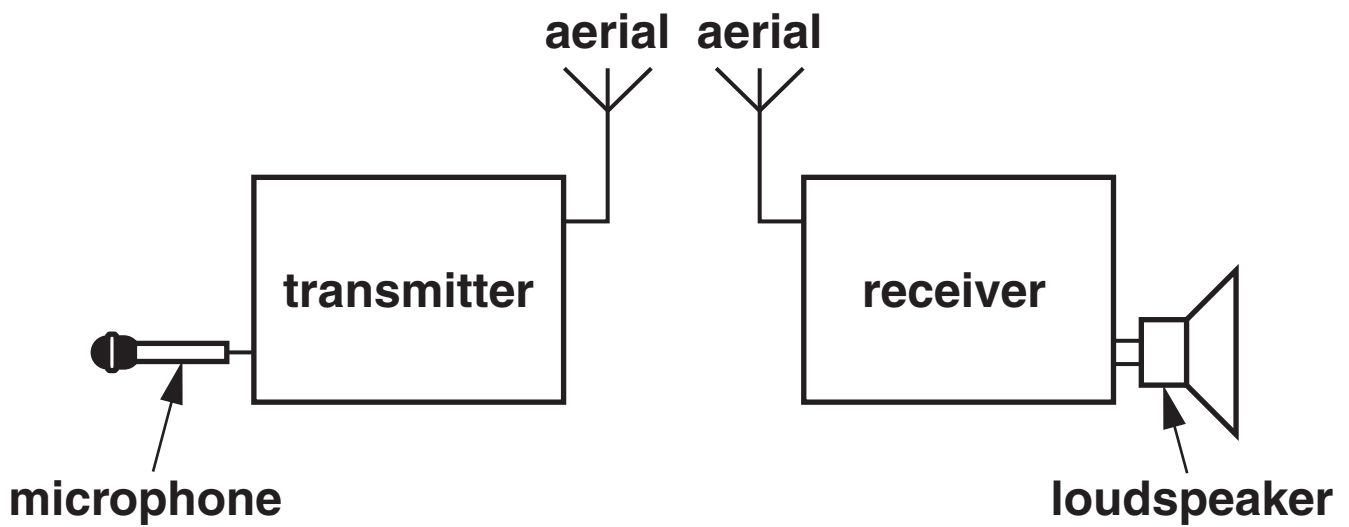

The microphone collects the analogue sound signals, which are then converted into digital radio signals. The digital radio signals are sent to a receiver.

(a) What is the difference between an ANALOGUE signal and a DIGITAL signal?

Draw diagrams to help you explain the answer.

[2]

(b) Complete the following sentences about the radio transmission system.

Use the BEST words from this list.

AMPLIFIED

ANALOGUE

DIGITAL

LOUDNESS

QUALITY

Radio signals have to be _____
because the further they travel the more they
decrease in intensity.

As they travel they pick up unwanted noise. This
noise reduces

the signal's _____ .

When the signal is amplified the noise is also
amplified. It is easier to remove the noise

if the signal is _____ . [3]

[Total: 5]

END OF QUESTION PAPER

BLANK PAGE

BLANK PAGE

BLANK PAGE



Copyright Information

OCR is committed to seeking permission to reproduce all third-party content that it uses in its assessment materials. OCR has attempted to identify and contact all copyright holders whose work is used in this paper. To avoid the issue of disclosure of answer-related information to candidates, all copyright acknowledgements are reproduced in the OCR Copyright Acknowledgements Booklet. This is produced for each series of examinations, is given to all schools that receive assessment material and is freely available to download from our public website (www.ocr.org.uk) after the live examination series.

If OCR has unwittingly failed to correctly acknowledge or clear any third-party content in this assessment material, OCR will be happy to correct its mistake at the earliest possible opportunity.

For queries or further information please contact the Copyright Team, First Floor, 9 Hills Road, Cambridge CB2 1GE.

OCR is part of the Cambridge Assessment Group; Cambridge Assessment is the brand name of University of Cambridge Local Examinations Syndicate (UCLES), which is itself a department of the University of Cambridge.