

Centre Number						Candidate Number				
Surname										
Other Names										
Candidate Signature										

For Examiner's Use	
Examiner's Initials	
Pages	Mark
3	
4 – 5	
6 – 7	
8 – 9	
10 – 11	
12 – 13	
14 – 15	
16 – 17	
18	
TOTAL	



General Certificate of Secondary Education
Higher Tier
January 2012

Methods in Mathematics (Linked Pair Pilot)

93652H

Unit 2 Geometry and Algebra

Thursday 19 January 2012 1.30 pm to 3.00 pm

H

For this paper you must have:

- a calculator
- mathematical instruments.

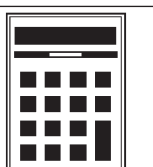

Time allowed

- 1 hour 30 minutes

Instructions

- Use black ink or black ball-point pen. Draw diagrams in pencil.
- Fill in the boxes at the top of this page.
- Answer **all** questions.
- You must answer the questions in the space provided. Do not write outside the box around each page or on blank pages.
- Do all rough work in this book. Cross through any work that you do not want to be marked.
- If your calculator does not have a π button, take the value of π to be 3.14 unless another value is given in the question.

Information

- The marks for questions are shown in brackets.
- The maximum mark for this paper is 80.
- The quality of your written communication is specifically assessed in Questions 1, 5 and 16. These questions are indicated with an asterisk (*).
- You may ask for more answer paper, graph paper and tracing paper. These must be tagged securely to this answer booklet.
- You are expected to use a calculator where appropriate.

Advice

- In all calculations, show clearly how you work out your answer.



J A N 1 2 9 3 6 5 2 H 0 1

WMP/Jan12/93652H

93652H

Formulae Sheet: Higher Tier

Area of trapezium = $\frac{1}{2}(a+b)h$

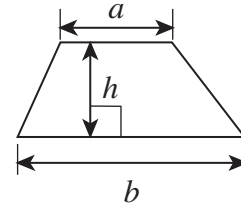

Volume of prism = area of cross-section \times length

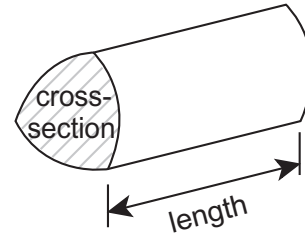

Volume of sphere = $\frac{4}{3}\pi r^3$

Surface area of sphere = $4\pi r^2$

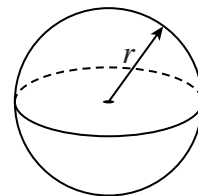

Volume of cone = $\frac{1}{3}\pi r^2 h$

Curved surface area of cone = $\pi r l$

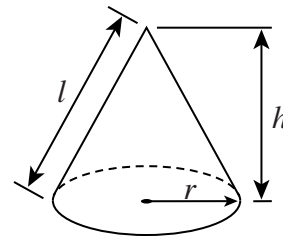

In any triangle ABC

Area of triangle = $\frac{1}{2}ab \sin C$

Sine rule $\frac{a}{\sin A} = \frac{b}{\sin B} = \frac{c}{\sin C}$

Cosine rule $a^2 = b^2 + c^2 - 2bc \cos A$

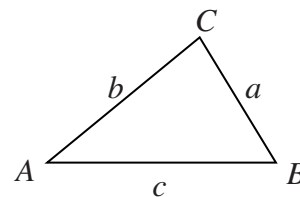

The Quadratic Equation

The solutions of $ax^2 + bx + c = 0$, where $a \neq 0$, are given by

$$x = \frac{-b \pm \sqrt{(b^2 - 4ac)}}{2a}$$



Answer **all** questions in the spaces provided.

***1** Decrease £632 by 7.5%.

.....
.....
.....

Answer £ (3 marks)

2 (a) Expand $5(x + 7)$

.....

Answer (1 mark)

2 (b) Factorise $3x - 12$

.....

Answer (1 mark)

2 (c) Expand and simplify $3(5x + 2) - 4(2x - 1)$

.....
.....
.....

Answer (3 marks)

3 Work out the area of the shape shown.

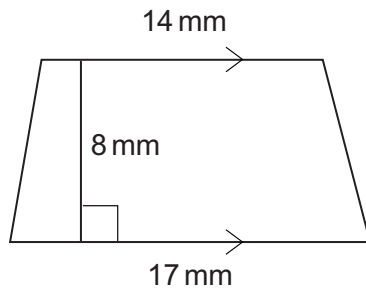

Not drawn accurately

.....
.....
.....

Answer mm² (2 marks)

10

Turn over ►



4 Match the appropriate Venn diagram with the following pairs of sets.

Pair X: Set A is the multiples of 4.
Set B is the multiples of 8.

Pair Y: Set A is the even numbers.
Set B is the odd numbers.

Pair Z: Set A is the multiples of 3.
Set B is the multiples of 5.

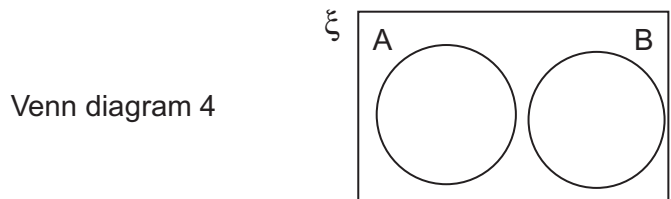
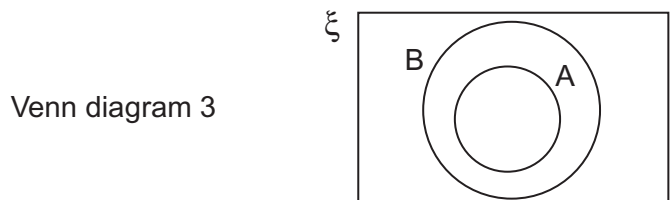
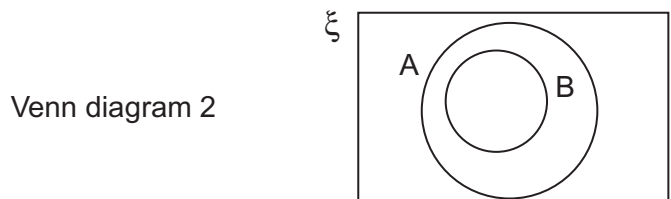
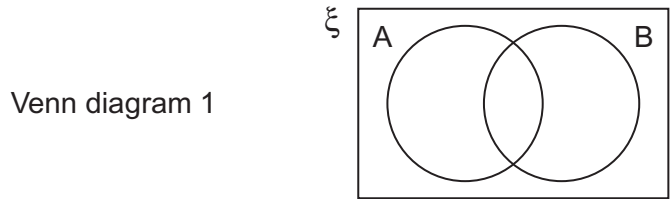

Answer Pair X matches Venn diagram

Pair Y matches Venn diagram

Pair Z matches Venn diagram (3 marks)



*5

A shape is shaded on a centimetre grid.

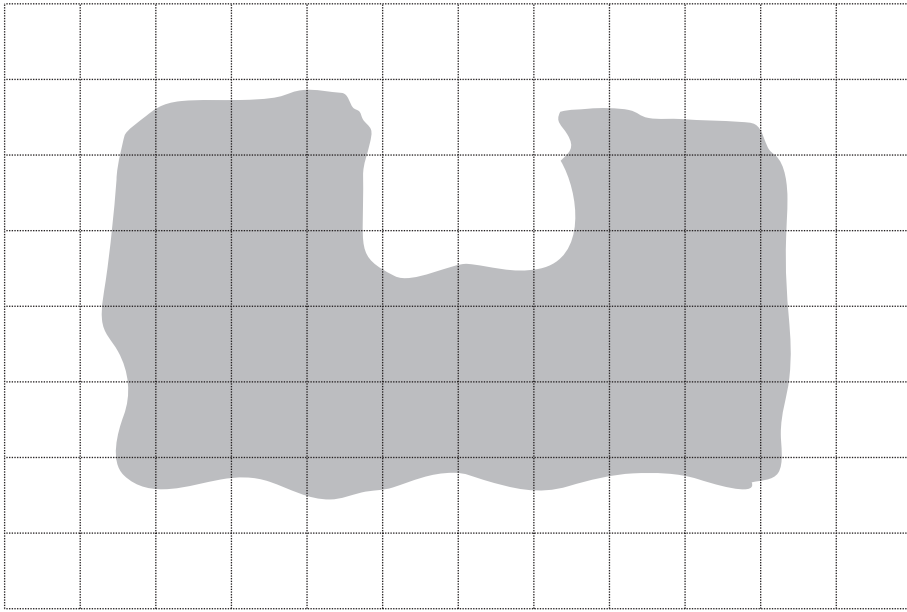

Simon says that the area of the shaded shape is between 24 cm^2 and 56 cm^2 .

Explain why Simon is correct.

You may mark the diagram to help you with your answer.

.....

.....

.....

.....

.....

.....

.....

.....

(3 marks)



6 Use your calculator to work out $\frac{3.17 + 8.42}{16.3 - 7.84}$

6 (a) Write down your full calculator display.
Give your answer as a decimal.

.....

Answer (1 mark)

6 (b) Write your answer to part (a) to 3 significant figures.

.....

Answer (1 mark)

7 Airmail stamps are 73p.
First class stamps are 42p.
Jack buys some of each.
He spends £40.97.

7 (a) How can you tell from the amount he spends that he buys an odd number of airmail stamps?

.....
.....

(1 mark)

7 (b) Jack buys four times as many first class stamps as airmail stamps.

How many of each stamp does he buy?

.....
.....
.....
.....

Answer Airmail stamps

First class stamps (3 marks)



8 (a) How many lines of symmetry does a square have?

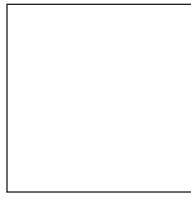

.....

Answer (1 mark)

8 (b) Here are three quadrilaterals.

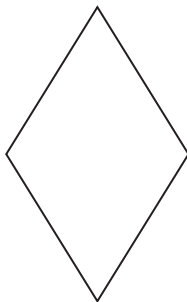

rhombus

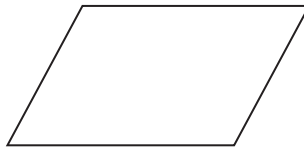

parallelogram

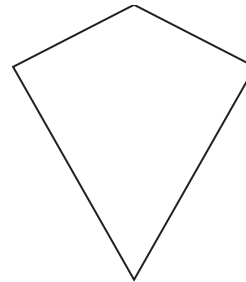

kite

Give a reason why each of the quadrilaterals could be the odd one out.

8 (b) (i) The rhombus could be the odd one out because

.....

(1 mark)

8 (b) (ii) The parallelogram could be the odd one out because

.....

(1 mark)

8 (b) (iii) The kite could be the odd one out because

.....

(1 mark)



9 (a) Solve the equation $9x - 3 = 5x + 2$

.....
.....
.....
.....

Answer $x =$ (3 marks)

9 (b) Solve the equation $\frac{4}{y} + 3 = 11$

.....
.....
.....
.....
.....

Answer $y =$ (3 marks)



10

Here are two number machines.

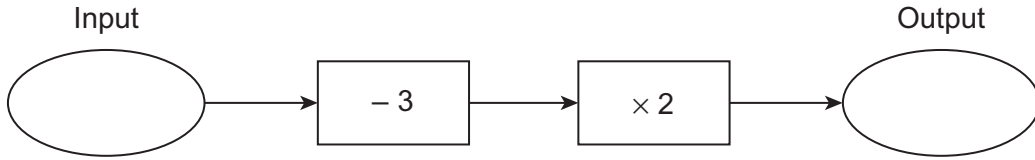
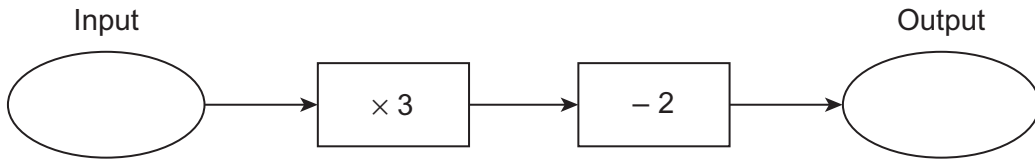

The same number is put into each machine.
The two outputs are equal.

What number is put in?

.....

.....

.....

.....

Answer (4 marks)

Turn over for the next question



11 (a) Work out the n th term of the sequence.

6 11 16 21 26

.....

Answer (2 marks)

11 (b) Work out the n th term of the sequence.

9 15 23 33 45

.....
.....
.....
.....
.....
.....
.....
.....
.....
.....
.....

Answer (4 marks)



12 Calculate the perimeter of this semicircle of radius 6.5 cm.

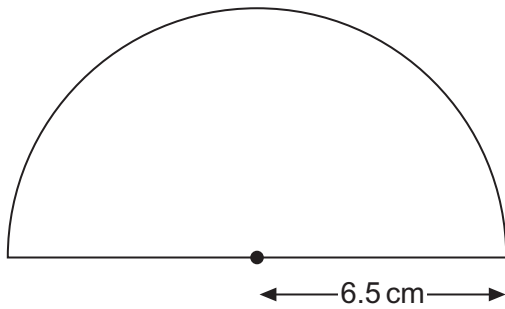

Not drawn accurately

.....

.....

.....

.....

Answer cm (3 marks)

13 Number A written as a product of its prime factors is $2 \times 3^2 \times 7$
 Number B written as a product of its prime factors is $2^2 \times 3 \times 5 \times 7$

13 (a) Show that the Highest Common Factor (HCF) of A and B is 42.

.....

.....

.....

.....

(1 mark)

13 (b) Work out the Least Common Multiple (LCM) of A and B.

.....

.....

.....

Answer (2 marks)



14 The diagram shows shapes A and B.

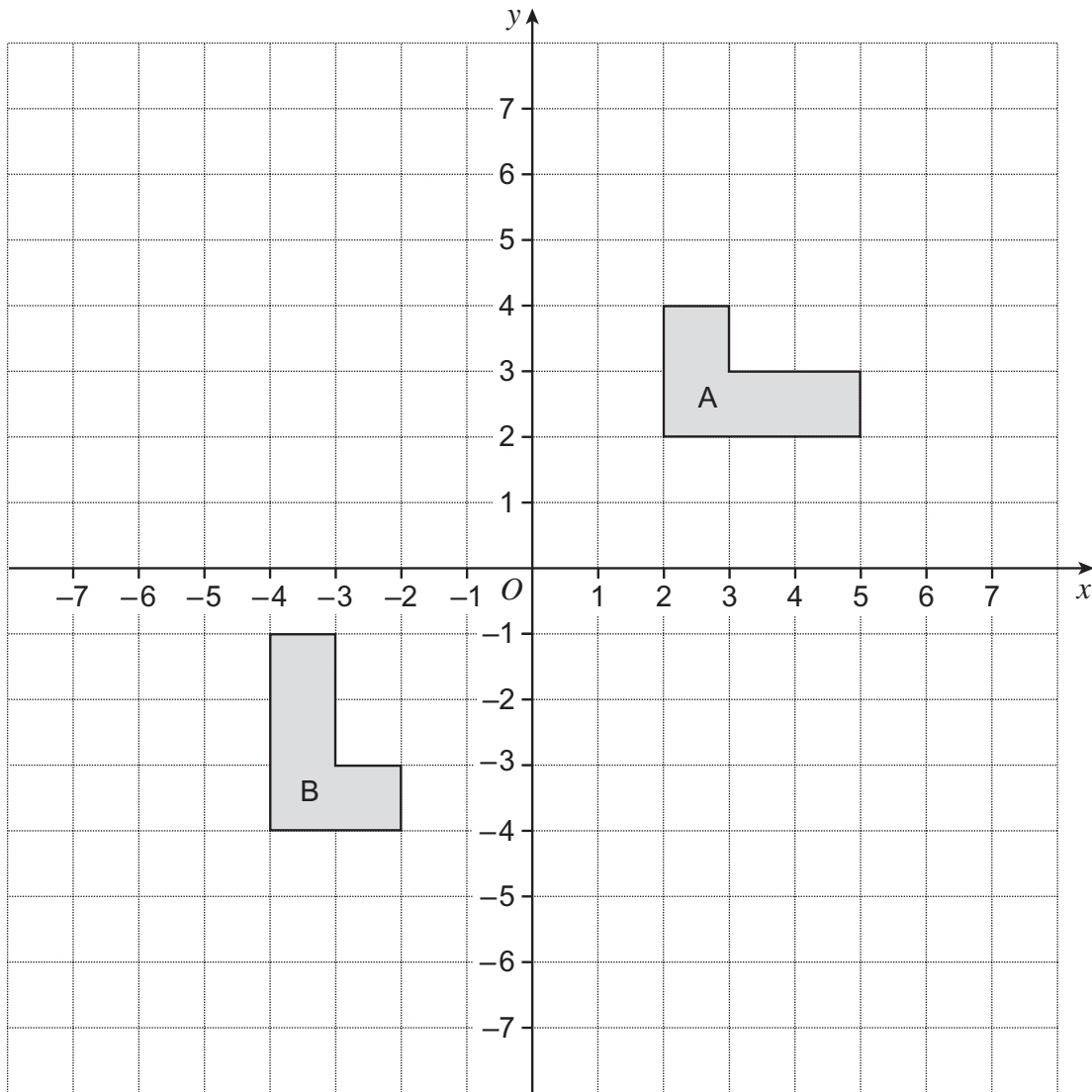

Shape A is mapped onto shape B by a reflection in one of the axes followed by a rotation.

Complete the sentence.

Shape A is mapped onto shape B by a reflection in
followed by a rotation

(3 marks)



15 (a) Calculate the length x in the triangle.

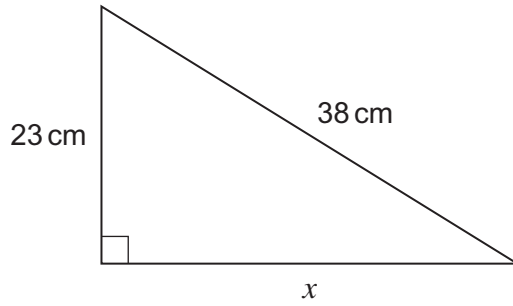

Not drawn accurately

.....

.....

.....

.....

.....

Answer cm (3 marks)

15 (b) Calculate the angle x in the triangle.

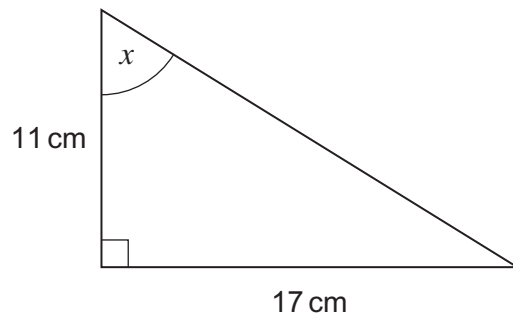

Not drawn accurately

.....

.....

.....

.....

.....

Answer degrees (3 marks)



16 (a) $ABCD$ are points on the circumference of a circle centre O .
Angle $AOC = 150^\circ$.

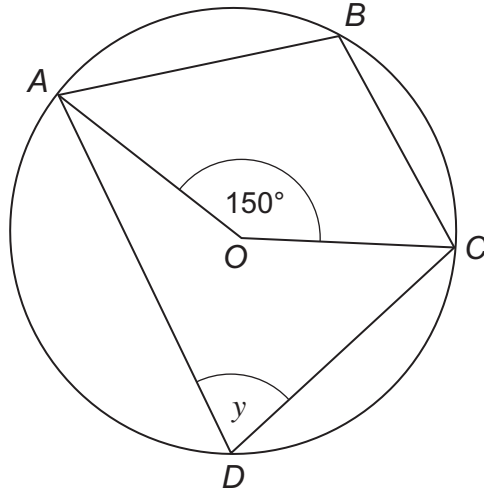

Not drawn
accurately

Write down the value of angle y .
Give a reason for your answer.

.....

Answer degrees

Reason

.....

(2 marks)



- *16 (b)** $ABCD$ is a cyclic quadrilateral.
 Triangle ABC is isosceles.
 XY is a tangent to the circle at D .
 Angle $ABC = 96^\circ$
 Angle $XDA = 54^\circ$

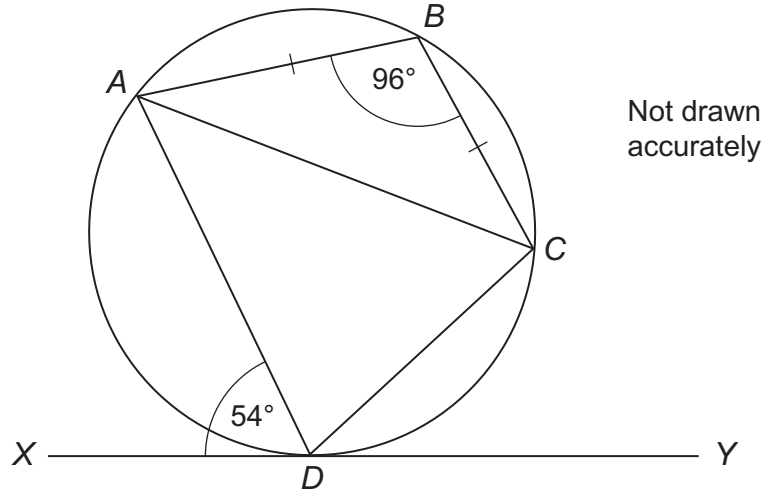

Prove that AD is parallel to BC .
 Give reasons for any angles you write down or calculate.

.....

.....

.....

.....

.....

.....

.....

.....

.....

.....

.....

(5 marks)



- 17 Triangle ABC has an area of 50 cm^2 .
 DE is parallel to AC .
 $AD = 6 \text{ cm}$ and $DB = 9 \text{ cm}$.

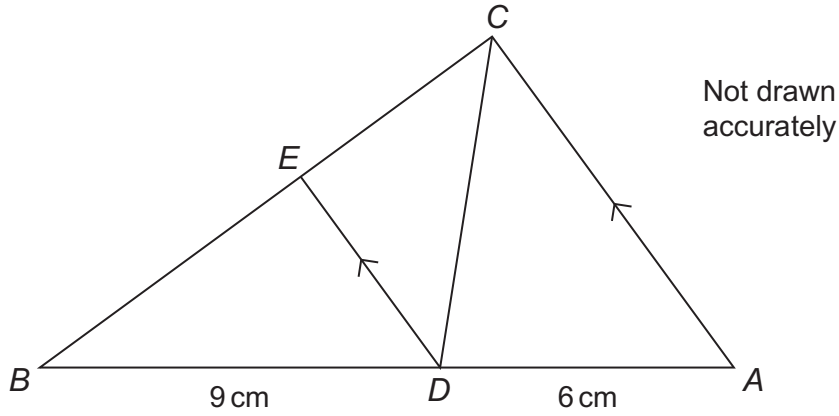

- 17 (a) Show clearly why the area of triangle BDC is 30 cm^2 .

.....

(2 marks)

- 17 (b) Work out the area of triangle BDE .

.....

Answer cm^2 (3 marks)



18 Solve the equation $\frac{5}{2x - 1} - \frac{2}{2x + 1} = 2$

.....

.....

.....

.....

.....

.....

.....

.....

.....

.....

.....

.....

.....

.....

.....

Answer $x =$ (6 marks)

Turn over for the next question



19 Max stands at a point A on the bank of a river with parallel straight sides.

He can see two posts at B and C on the other side of the river.
He knows the posts are 100 metres apart.

The angle between the bank and the line AB is 30° .
The angle between the bank and the line AC is 35° .

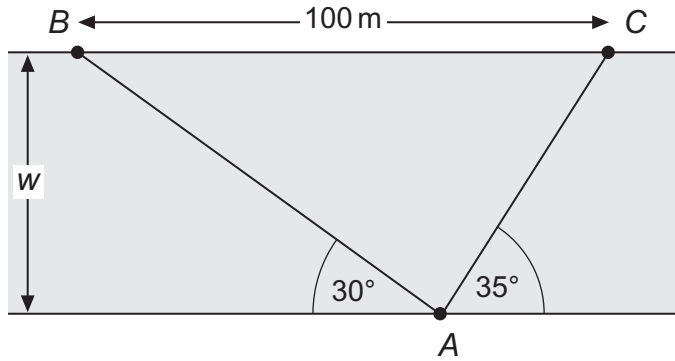

Not drawn accurately

Work out the width of the river, w .

.....

.....

.....

.....

.....

.....

.....

.....

.....

.....

.....

.....

.....

.....

.....

.....

.....

.....

.....

.....

.....

.....

Answer m (5 marks)

END OF QUESTIONS

5



There are no questions printed on this page

**DO NOT WRITE ON THIS PAGE
ANSWER IN THE SPACES PROVIDED**



There are no questions printed on this page

**DO NOT WRITE ON THIS PAGE
ANSWER IN THE SPACES PROVIDED**

