

Candidate forename		Candidate surname	
-----------------------	--	----------------------	--

Centre number						Candidate number				
------------------	--	--	--	--	--	---------------------	--	--	--	--

**OXFORD CAMBRIDGE AND RSA EXAMINATIONS
GENERAL CERTIFICATE OF SECONDARY EDUCATION**

B276B

**MATHEMATICS C
(GRADUATED ASSESSMENT)**

MODULE M6 (SECTION B)

TUESDAY 21 JUNE 2011: Afternoon

DURATION: 30 minutes

SUITABLE FOR VISUALLY IMPAIRED CANDIDATES

Candidates answer on the question paper.

OCR SUPPLIED MATERIALS:

None

OTHER MATERIALS REQUIRED:

Geometrical instruments

Tracing paper (optional)

Scientific or graphical calculator

READ INSTRUCTIONS OVERLEAF

INSTRUCTIONS TO CANDIDATES

- **Write your name, centre number and candidate number in the boxes on the first page. Please write clearly and in capital letters.**
- **Use black ink. Pencil may be used for graphs and diagrams only.**
- **Read each question carefully. Make sure you know what you have to do before starting your answer.**
- **Write your answer to each question in the space provided. Additional paper may be used if necessary but you must clearly show your candidate number, centre number and question number(s).**
- **Show your working. Marks may be given for a correct method even if the answer is incorrect.**
- **Answer ALL the questions.**

INFORMATION FOR CANDIDATES

- **The number of marks is given in brackets [] at the end of each question or part question.**
- **Section B starts with question 8.**
- **You are expected to use a calculator in Section B of this paper.**
- **Use the π button on your calculator or take π to be 3.142 unless the question says otherwise.**
- **The total number of marks for this Section is 25.**

FORMULAE SHEET

Area of trapezium = $\frac{1}{2} (a + b)h$

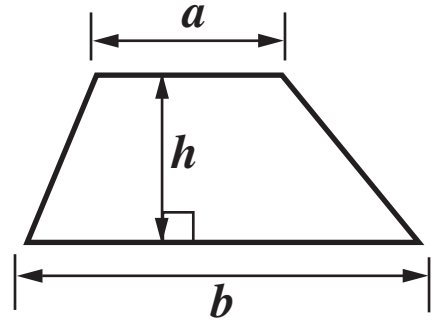

Volume of prism = (area of cross-section) \times length

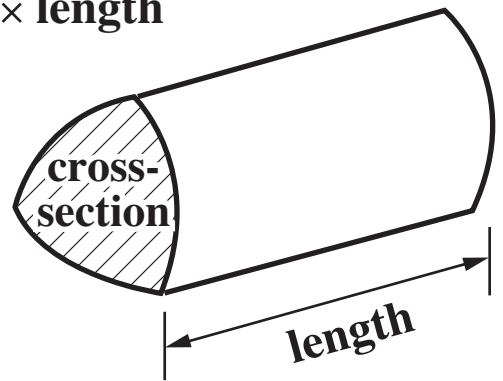

8 This is a sketch of a quadrilateral PQRS.

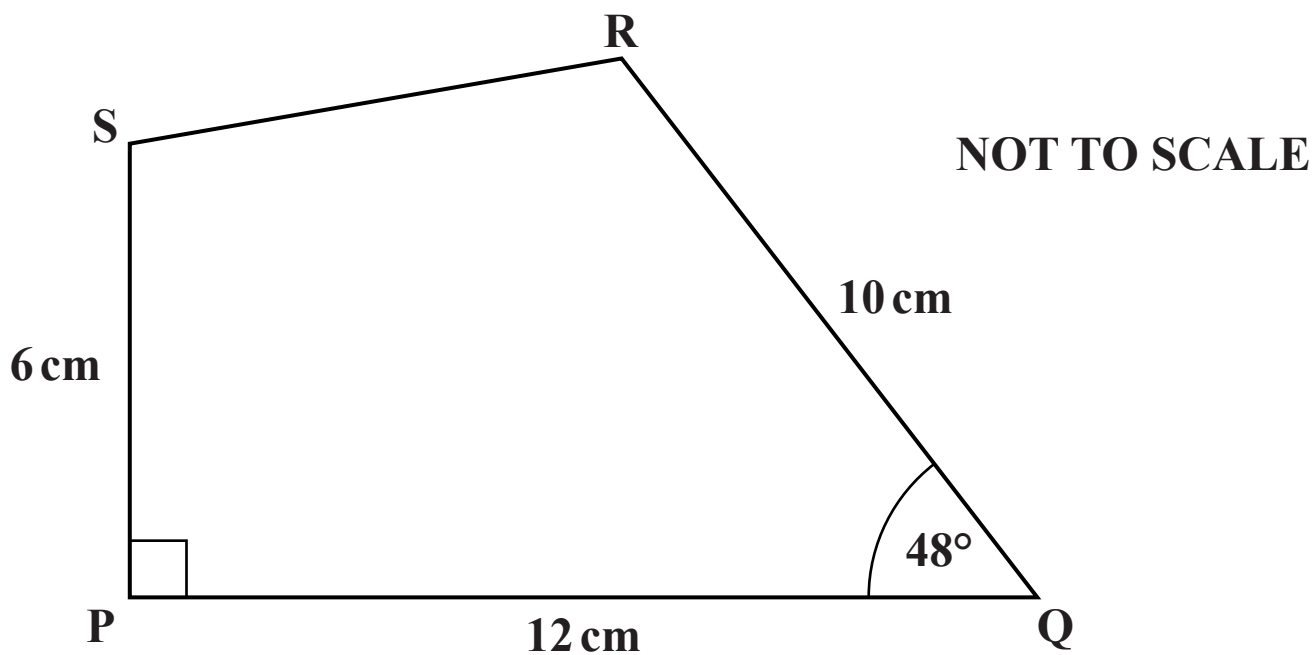

- (a) Use ruler and protractor to construct this quadrilateral. The side PQ has been drawn for you.**

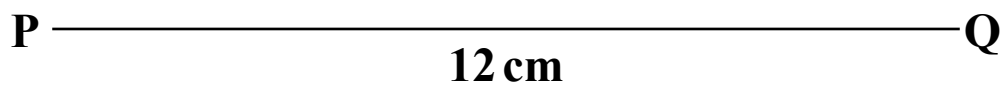

[3]

(b) Measure angle PSR in your quadrilateral.

(b) _____[°] [1]

9 This table shows the engine sizes and the CO₂ emissions of ten cars.

Engine size (litres)	1·0	1·2	1·2	1·3	1·6	1·6	1·8	2·0	2·5	3·0
CO ₂ emissions (g/km)	105	138	125	130	159	179	152	170	235	249

(a) Complete the scatter diagram below.
The first eight points have been plotted for you.

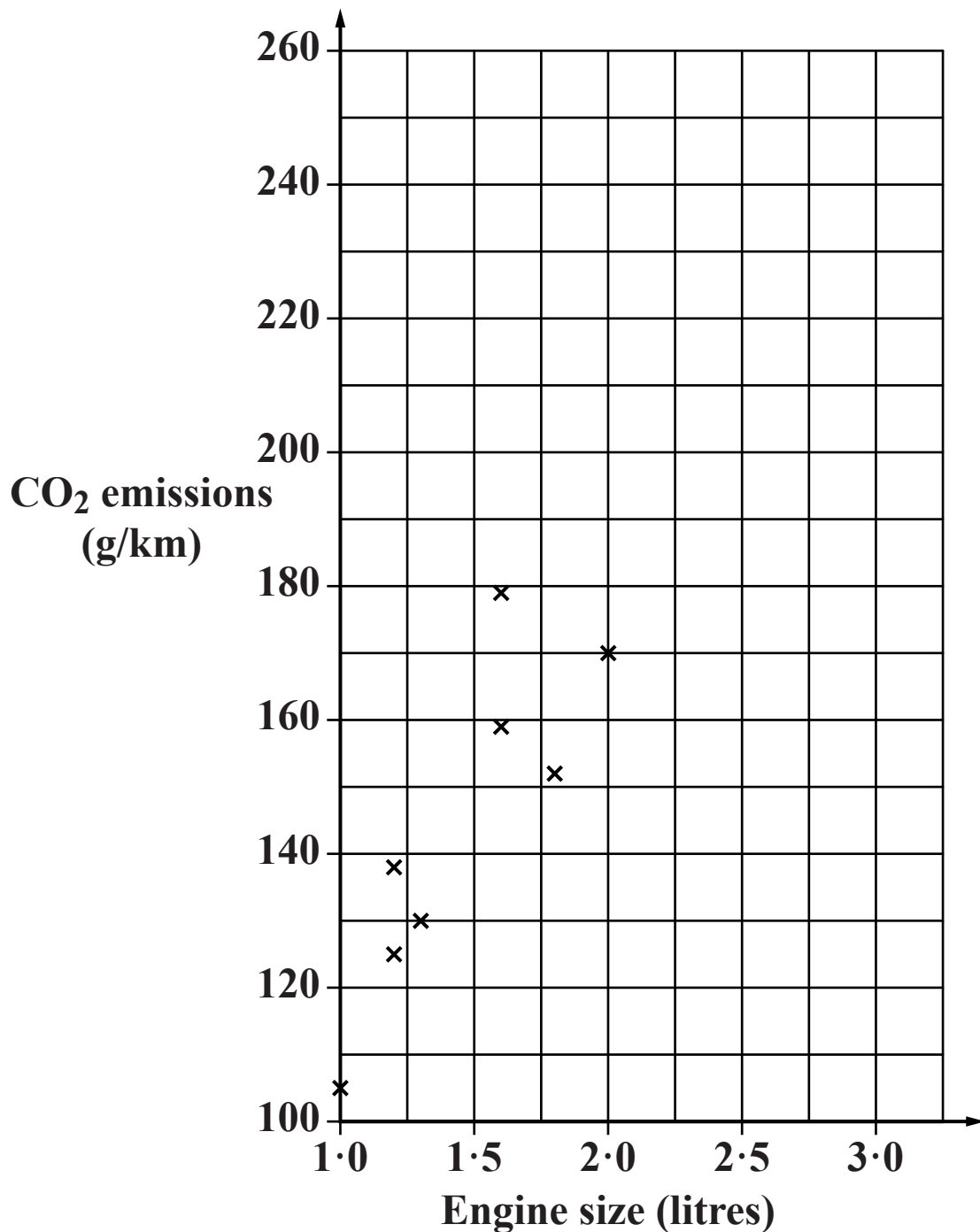

(b) What does the diagram show about the relationship between engine size and CO₂ emissions?

[1]

(c) Alwyn's car has an engine size of 2·2 litres.

Use the diagram to estimate the CO₂ emissions of his car.

(c) _____ g/km [1]

10 Draw the graph of $x + 2y = 10$ for values of x from 0 to 10. You may use this table to help you.

x	0		
y	5		

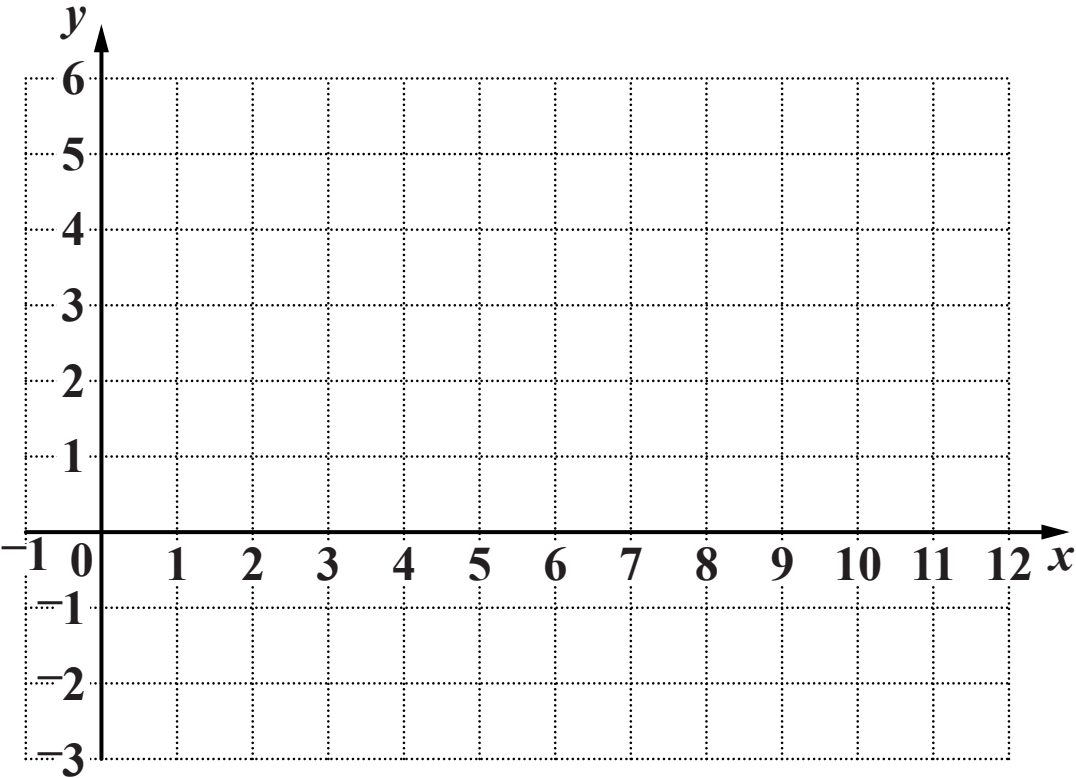

[3]

- 11 (a) On holiday Howard travelled 750 miles on motorways and 450 miles on ordinary roads.**

Write down the ratio of the number of miles on motorways to the number of miles on ordinary roads. Give your answer in its simplest form.

(a) _____ : _____ [2]

(b) Sandra travelled 840 miles altogether in France and Switzerland.

The ratio of the distance travelled in France to the distance travelled in Switzerland was 3 : 1.

How far did she travel in Switzerland?

(b) _____ miles [2]

12 (a) Calculate.

$$\frac{25 \cdot 26 + 15 \cdot 6}{7 \cdot 8 - 1 \cdot 48}$$

Give your answer correct to 1 decimal place.

(a) _____ [2]

**(b) Owain spends 2.25 hours watching television.
He says that 2.25 hours is 2 hours 25 minutes.
He is wrong.**

Write 2.25 hours in hours and minutes.

(b) _____ hours _____ minutes [1]

**13 Helen buys a 17.5 kg bag of lawn feed.
The lawn feed will cover an area of 500 m².**

**(a) How many square metres of lawn can be covered by
1 kilogram of the lawn feed?**

(a) _____ m² [1]

**(b) Helen uses the lawn feed on her lawn.
Her lawn has an area of 180 m².**

How much lawn feed should she have left?

(b) _____ kg [3]

- 14 A watertight glass container is a cuboid measuring 35 cm by 30 cm by 20 cm.
The water in the container is 12 cm deep as shown.

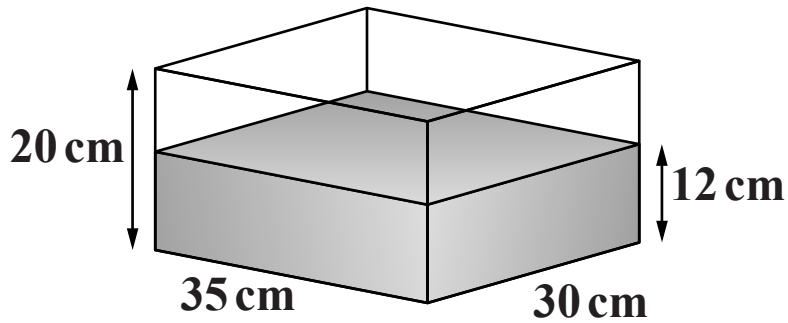

The container is turned to stand on its end as shown.

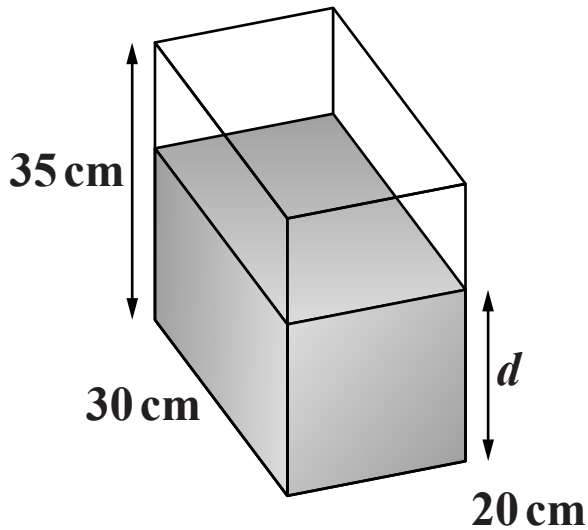

Work out the depth, d , of the water in this position.

_____ cm [4]

BLANK PAGE

BLANK PAGE



Copyright Information

OCR is committed to seeking permission to reproduce all third-party content that it uses in its assessment materials. OCR has attempted to identify and contact all copyright holders whose work is used in this paper. To avoid the issue of disclosure of answer-related information to candidates, all copyright acknowledgements are reproduced in the OCR Copyright Acknowledgements Booklet. This is produced for each series of examinations and is freely available to download from our public website (www.ocr.org.uk) after the live examination series.

If OCR has unwittingly failed to correctly acknowledge or clear any third-party content in this assessment material, OCR will be happy to correct its mistake at the earliest possible opportunity.

For queries or further information please contact the Copyright Team, First Floor, 9 Hills Road, Cambridge CB2 1GE.

OCR is part of the Cambridge Assessment Group; Cambridge Assessment is the brand name of University of Cambridge Local Examinations Syndicate (UCLES), which is itself a department of the University of Cambridge.