

Surname	Initial(s)
Signature	

Paper Reference(s)

5382F/07

Edexcel GCSE

Mathematics (Modular) – 2381

Paper 7 (Non-Calculator)

Foundation Tier



Unit 2 Stage 1

Thursday 17 November 2011 – Afternoon

Time: 30 minutes

Materials required for examination

Multiple Choice Answer Sheet.
Ruler graduated in centimetres and millimetres, protractor, compasses, HB pencil, eraser.

Items included with question papers

Nil

Instructions to Candidates

Use a HB pencil. Do not open this booklet until you are told to do so.

Before the test begins:

Check that the answer sheet is for the correct test and that it contains your candidate details.

How to answer the test:

For each question, choose the right answer, A, B, C, D or E and mark it in HB pencil on the answer sheet.

For example, the answer C would be marked as shown.



Mark only **one** answer for each question. If you change your mind about an answer, rub out the first mark **completely**, then mark your new answer.

Answer **all** the questions.

Do any necessary calculations and rough work in this booklet. **Calculators must not be used.**

You must not take this booklet or the answer sheet out of the examination room.

Information for Candidates

There are 25 questions in this question paper. The total mark for this paper is 25.

There are 12 pages in this question paper. Any blank pages are indicated.

Advice to Candidates

Work steadily through the paper. Do not spend too long on one question.

If you cannot answer a question, leave it and attempt the next one.

Return at the end to those you have left out.

Printer's Log. No.

P40100A



Turn over

GCSE Mathematics 2381

Formulae: Foundation Tier

**You must not write on this formulae page.
Anything you write on this formulae page will gain NO credit.**

Area of trapezium = $\frac{1}{2}(a + b)h$

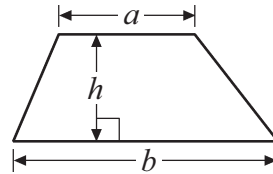

Volume of prism = area of cross section \times length

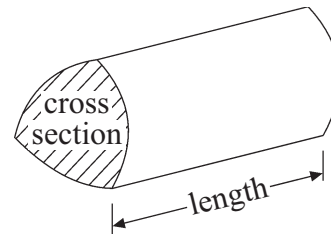

Answer ALL TWENTY FIVE questions using the answer sheet.

You must NOT use a calculator.

1. What is six thousand and fifty seven when written in figures?

6570

A

600 057

B

657

C

6057

D

6507

E

2. Which number is a multiple of 10?

5

A

30

B

2

C

25

D

1

E

- 3.

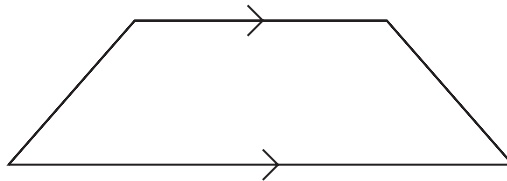

What is the special name of this quadrilateral?

Parallelogram

A

Rhombus

B

Rectangle

C

Kite

D

Trapezium

E

4. 54 328 people watched a concert.

The number 54 328 when rounded to the nearest hundred is

54 300

A

50 000

B

54 000

C

54 400

D

54 330

E

5. Here is a shaded shape drawn on a centimetre grid.

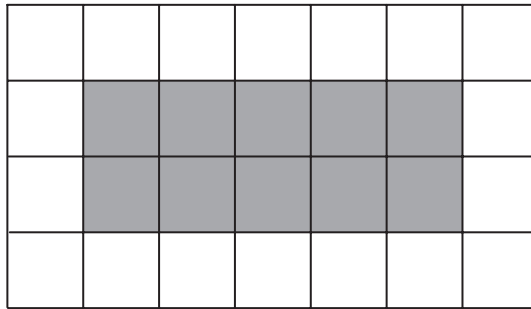

What is the area of the shaded shape?

14 cm²
A

10 cm²
B

28 cm²
C

18 cm²
D

22 cm²
E

6. Here are the first four numbers in a sequence.

4 7 10 13

The next number in the sequence is

15
A

14
B

16
C

19
D

17
E

7. The fraction $\frac{40}{60}$ when written in its simplest form is

$\frac{20}{30}$
A

$\frac{4}{6}$
B

$\frac{2}{3}$
C

$\frac{3}{5}$
D

$\frac{8}{12}$
E

8. Here is a sequence of patterns made from sticks.



Pattern 1



Pattern 2



Pattern 3

Pattern	1	2	3
Number of sticks	5	9	13

What is the number of sticks needed for Pattern 6?

17
A

29
B

21
C

26
D

25
E

9. One list of decimals is in order of size.
Which one?

8.23
8.32
8.3
8.03
8.2

A

8.2
8.03
8.3
8.23
8.32

B

8.03
8.2
8.3
8.23
8.32

C

8.03
8.2
8.23
8.3
8.32

D

8.2
8.23
8.03
8.3
8.32

E

10. Pencils cost 21p each.

Sarah buys 7 pencils.
She pays with a £5 note.

How much change should she get?

£3.53
A

£4.47
B

£1.47
C

£3.63
D

£4.53
E

11.

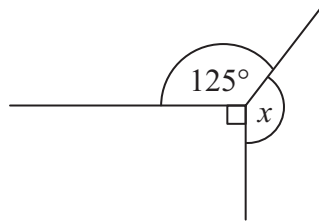

Diagram **NOT**
accurately drawn

What is the size of the angle marked x ?

235°
A

215°
B

155°
C

145°
D

55°
E

12. What is 3.5 metres in centimetres?

35 cm
A

3500 cm
B

305 cm
C

3.50 cm
D

350 cm
E

13. Buns cost x pence each.
Doughnuts cost y pence each.

James buys 3 buns and 5 doughnuts.

Which is the expression for the total cost in pence?

$15xy$
A

$3x + 5y$
B

$5x + 3y$
C

$8(x + y)$
D

$x + y$
E

14. A bus leaves Cambridge at 13 40
It arrives in London at 15 25

How long does the journey take?

2 hours
45 minutes
A

3 hours
45 minutes
B

2 hours
15 minutes
C

1 hour
45 minutes
D

3 hours
15 minutes
E

15. $24 - 4 \times 5 =$

-4
A

100
B

4
C

10
D

14
E

16. Here is an isosceles triangle.

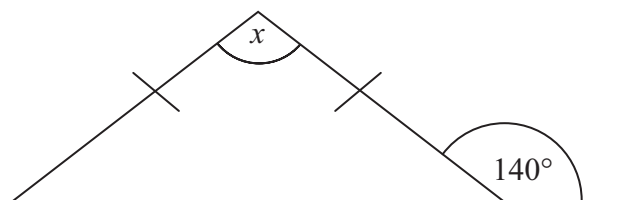

Diagram **NOT**
accurately drawn

What is the size of the angle marked x ?

40°
A

100°
B

70°
C

140°
D

80°
E

17. Here is a list of numbers

1, 2, 6, 7, 9, 12

Which two of these numbers are prime numbers?

2 and 7
A

1 and 7
B

2 and 9
C

1 and 9
D

6 and 12
E

18. $-4 \times -5 =$

-20
A

-9
B

9
C

1
D

20
E

19. $316 \times 54 =$

17064
A

2844
B

16064
C

2944
D

15000
E

20. The n th term of a sequence is $5n + 1$

What is the 7th term of the sequence?

36
A

7
B

58
C

12
D

43
E

21. What is 90 written as a product of its prime factors?

$2 + 3 + 3 + 5$
A

$3 \times 3 \times 10$
B

9×10
C

$2 \times 3 \times 3 \times 5$
D

$2, 3, 3, 5$
E

22. What are the coordinates of the midpoint of the line joining (4, 6) to (8, 9)?

(12, 15)
A

(4, 3)
B

$(6, 7\frac{1}{2})$
C

$(2, 1\frac{1}{2})$
D

$(7\frac{1}{2}, 6)$
E

23.

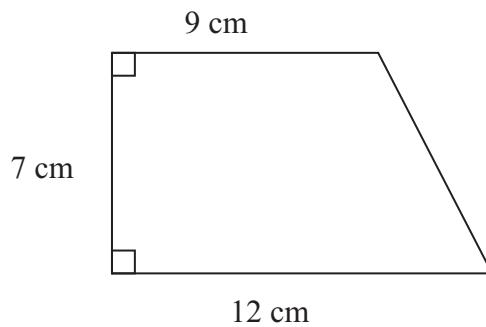

Diagram **NOT**
accurately drawn

What is the area of this shape?

84 cm^2
A

73.5 cm^2
B

28 cm^2
C

108 cm^2
D

756 cm^2
E

24.

Cinema tickets

Adult £7.50

Child £3.50

Family (2 adults and 2 children) £19.50

Sunil wants to buy cinema tickets for 4 adults and 4 children.

It is cheaper for him to buy family tickets.

How much cheaper?

£2.50

A

£8.50

B

£5

C

£17

D

£6

E

25. Here are the first 5 terms of an arithmetic sequence.

9 15 21 27 33

Which is the expression for the n th term of the sequence?

$n + 6$

A

$3n + 6$

B

$6n$

C

$6n - 3$

D

$6n + 3$

E

TOTAL FOR PAPER: 25 MARKS

END

BLANK PAGE

BLANK PAGE