

Centre Number						Candidate Number				
Surname										
Other Names										
Candidate Signature										



General Certificate of Secondary Education
Foundation Tier
November 2014

Applications of Mathematics (Linked Pair)

93702F

Unit 2 Geometry and Measures

F

Friday 7 November 2014 9.00 am to 10.30 am

<p>For this paper you must have:</p> <ul style="list-style-type: none"> • a calculator • mathematical instruments. 	
---	--

Time allowed

- 1 hour 30 minutes

Instructions

- Use black ink or black ball-point pen. Draw diagrams in pencil.
- Fill in the boxes at the top of this page.
- Answer **all** questions.
- You must answer the questions in the space provided. Do not write outside the box around each page or on blank pages.
- Do all rough work in this book. Cross through any work that you do not want to be marked.
- If your calculator does not have a π button, take the value of π to be 3.14 unless another value is given in the question.

Information

- The marks for questions are shown in brackets.
- The maximum mark for this paper is 80
- The quality of your written communication is specifically assessed in Questions 4, 5, 10 and 17
These questions are indicated with an asterisk (*).
- You may ask for more answer paper, graph paper and tracing paper. These must be tagged securely to this answer book.
- You are expected to use a calculator where appropriate.

Advice

- In all calculations, show clearly how you work out your answer.

For Examiner's Use	
Examiner's Initials	
Pages	Mark
3	
4 – 5	
6 – 7	
8 – 9	
10 – 11	
12 – 13	
14 – 15	
16 – 17	
18 – 19	
20 – 21	
22 – 23	
24 – 25	
26 – 27	
TOTAL	



N 0 V 1 4 9 3 7 0 2 F 0 1

Formulae Sheet: Foundation Tier

Area of trapezium = $\frac{1}{2}(a+b)h$

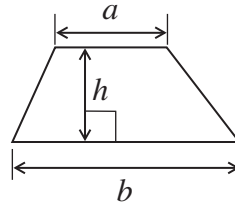

Volume of prism = area of cross section \times length

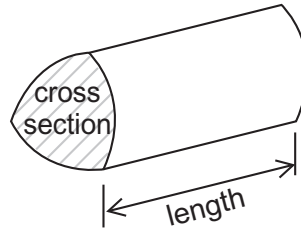

Answer **all** questions in the spaces provided.

1 Estimate each of the following.

Circle your answer.

1 (a) The thickness of a DVD case.

[1 mark]

0.08 mm

0.8 mm

8 mm

80 mm

1 (b) The weight of a tennis ball.

[1 mark]

5.7 g

57 g

570 g

5700 g

1 (c) The area of this page.

[1 mark]

50 cm²

100 cm²

250 cm²

650 cm²

1 (d) The height of a 4-year old child.

[1 mark]

10 cm

100 cm

200 cm

300 cm



2 The shaded areas show two designs for jewellery on a centimetre grid.

Design A

Design B

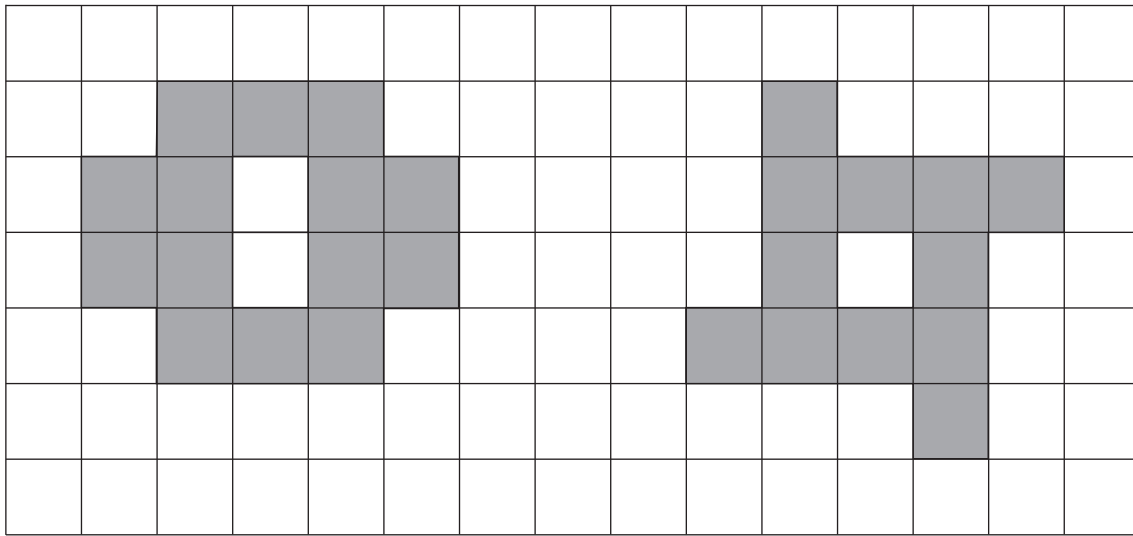

2 (a) How many lines of symmetry does **design A** have?

[1 mark]

Answer

2 (b) Write down the order of rotational symmetry of **design B**.

[1 mark]

Answer



2 (c) **Design B** is made into a metal pendant and attached to a chain.

The metal costs £1.78 per square centimetre.

The chain costs £2.50

Work out the total cost of the pendant and the chain.

[3 marks]

.....

.....

.....

.....

£

Turn over for the next question

5

Turn over ►



3 You need a ruler and compasses to answer this question.

The diagram shows a circle inside a square.

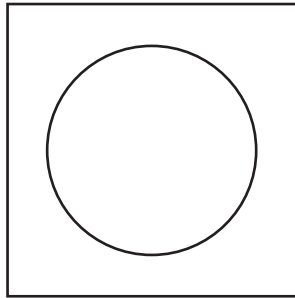

Not drawn
accurately

The diagram is used on a flag.

3 (a) Draw a circle, radius 4 cm, inside the square.
The centre of the circle is marked with a cross.

[1 mark]

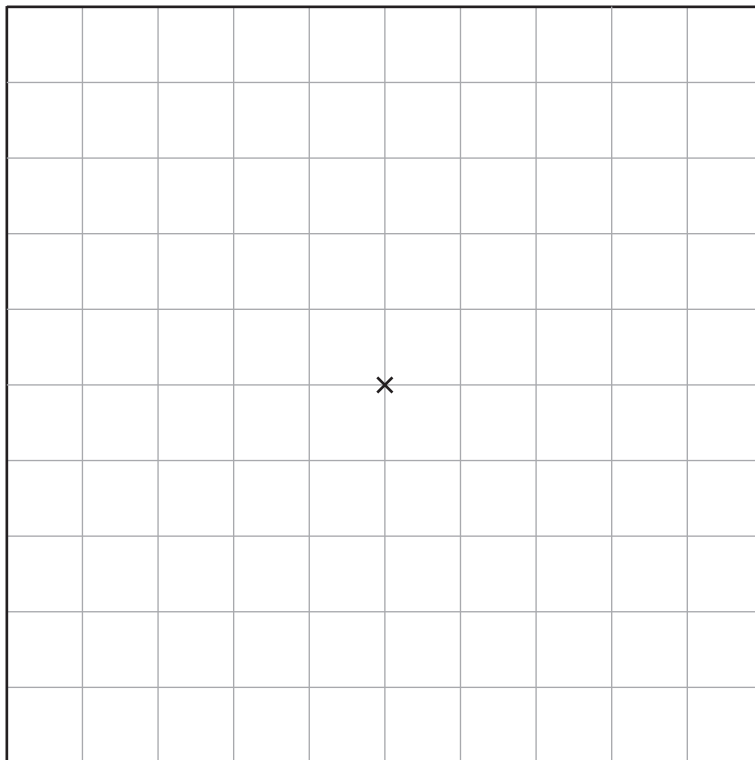

3 (b) A straight line is drawn on the diagram.
The line is
a diameter of the circle
parallel to the horizontal sides of the square.

Draw the line on your diagram in part (a).

[2 marks]



*4 A shirt costs £12
A jacket costs £18

The shirts and jackets are both sold at shop A and shop B.

Shop A
£5 off when you spend £15 or more

Shop B
Spend over £20 and get £4 off
or
Spend between £10 and £20 and get £2 off

Work out the cheapest way to buy a shirt and a jacket.

[3 marks]

Buy the shirt at shop

Buy the jacket at shop

Cheapest total cost £

.....
.....
.....
.....
.....
.....
.....
.....
.....
.....
.....

6

Turn over ►



5 The costs to have a parcel delivered the next day are shown below.

		Delivered before 9 am	Delivered before 10 am	Delivered before 12 noon
Weight of parcel	up to 2 kg	£36.45	£27.32	£16.27
	up to 5 kg	£39.57	£30.90	£20.85
	up to 10 kg	£42.50	£33.50	£24.68
	up to 15 kg	£48.62	£40.46	£30.75

5 (a) How much does it cost to have a 14 kg parcel delivered before 10 am?

[1 mark]

£

5 (b) A 3 kg parcel is delivered before 9 am

How much **less** would it have cost for the parcel to be delivered before 12 noon?

[2 marks]

.....
.....
.....

£



***5 (c)** Rhian has five small parcels to be delivered to the same address.

Each of the five parcels weighs 1.5 kg

They need to be delivered before 12 noon.

She puts the five small parcels together to make one large parcel.



Rhian

It will be more than £50 cheaper to have the large parcel delivered instead of the five small parcels.

Is Rhian correct?
You **must** show your working.

[4 marks]

.....

.....

.....

.....

.....

.....

.....

.....

.....

7

Turn over ►



6 Here is a conversion graph for pounds (£) and dollars (\$).

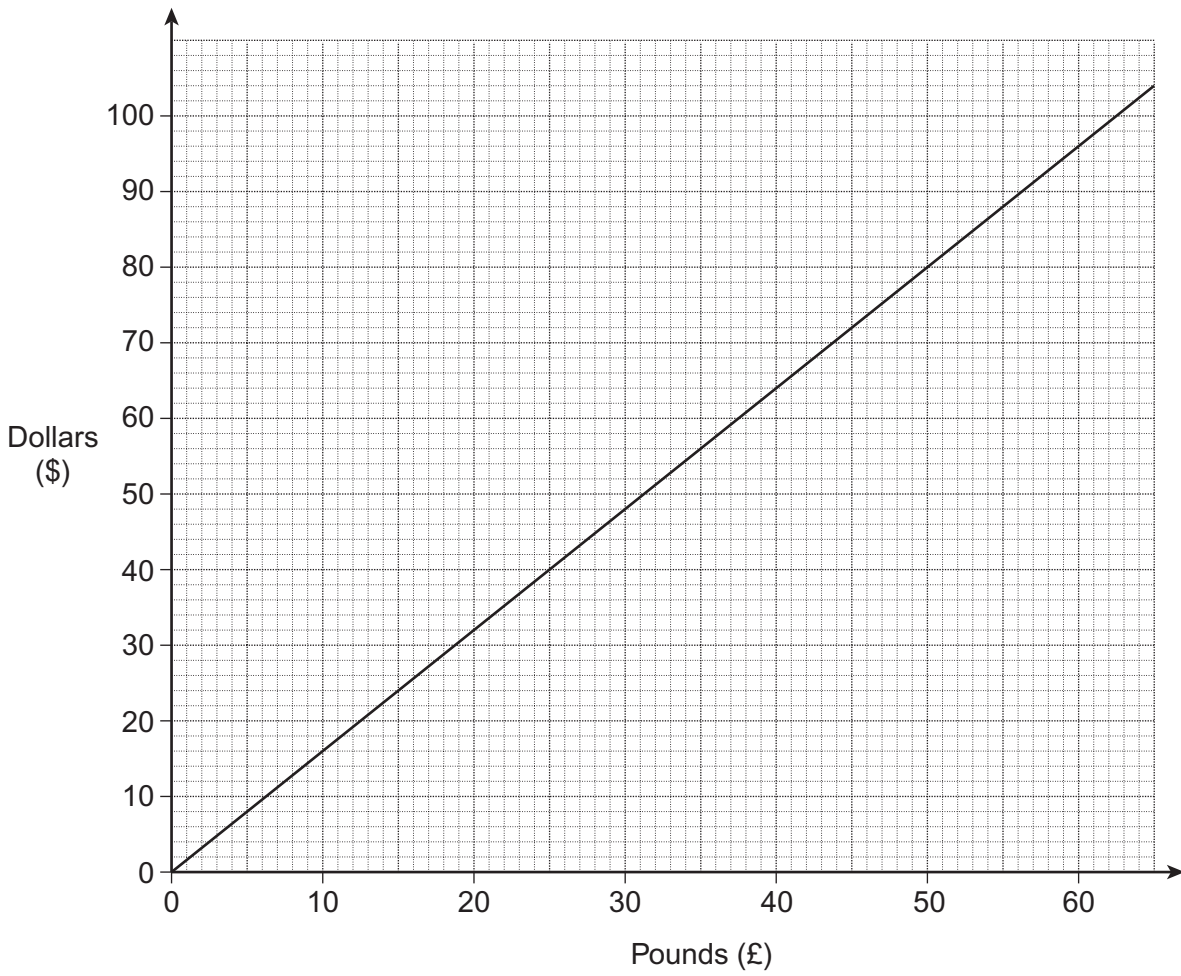

6 (a) Convert £60 to dollars.

[1 mark]

\$

6 (b) Convert \$240 to pounds.

[2 marks]

.....

£



6 (c) Here is a conversion graph for euros (€) and dollars (\$).

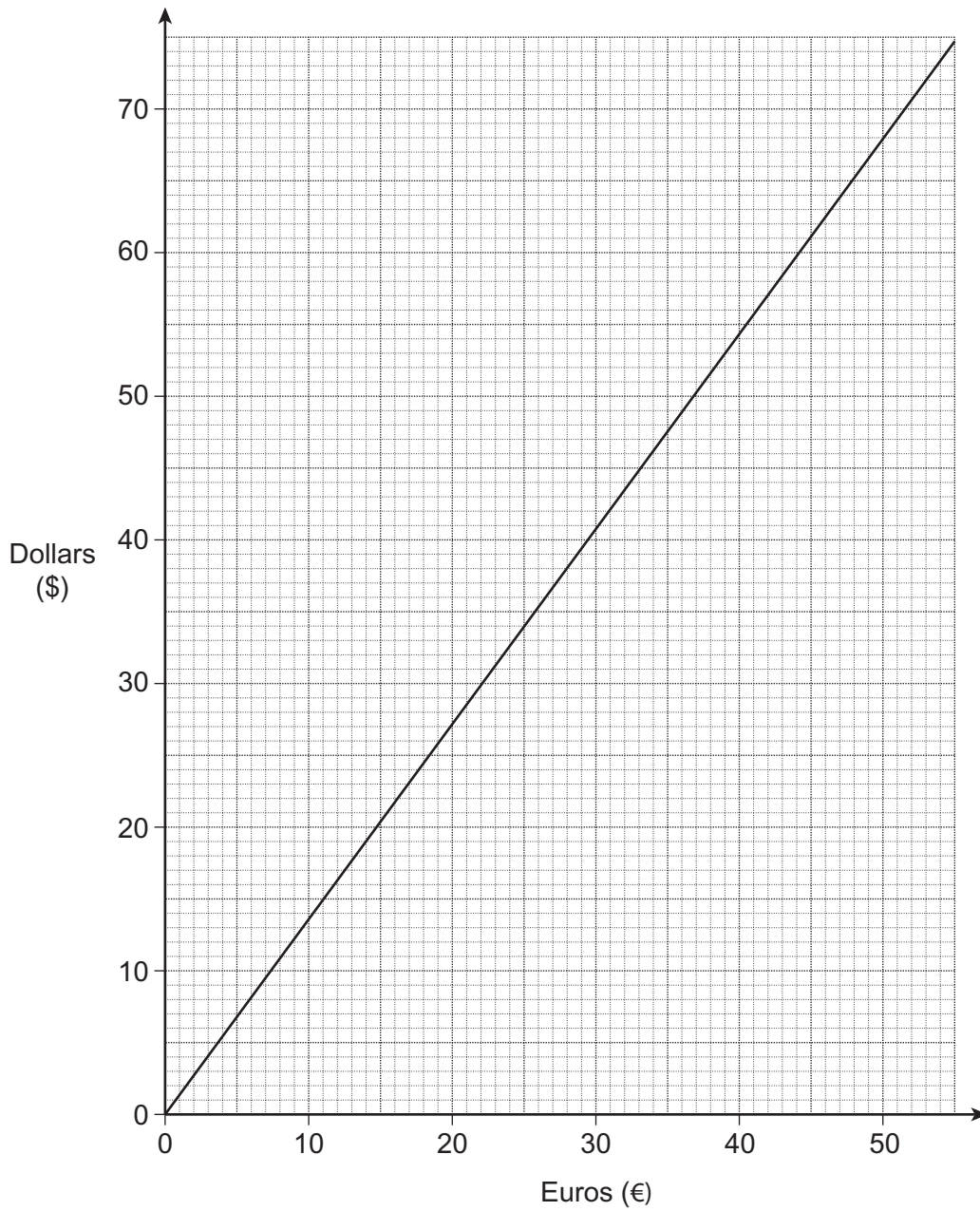

Use **both** graphs to convert 25 euros to pounds.

[2 marks]

.....

.....

£

5

Turn over ►



7 Members of a Maths Club want to raise money for new equipment.
Tickets numbered from 1 to 160 are put in a box.
People pay to pick tickets from the box.

7 (a) A ticket with a multiple of 35 wins a calculator.
List **all** the ticket numbers that win a calculator.

[2 marks]

.....
.....

Answer

7 (b) A ticket with a prime number wins a pen.
Circle the ticket numbers that win a pen.

[2 marks]

9 13 17 21 29



8



My height is 176 centimetres.
My weight is 138 pounds.
I was born in August 1993

Jamie

Jamie has an application form for a gym.

Complete the application form.
Use 1 kilogram = 2.2 pounds

[4 marks]

AQA Gym

Date Friday 7 November 2014

Name Jamie Jones

Height metres

Weight kilograms (to nearest kg)

Age years (in completed years)

.....

.....

.....

.....

8

Turn over ►



- 9 A puzzle is made from three pieces.
The pieces fit together to make a rectangle.

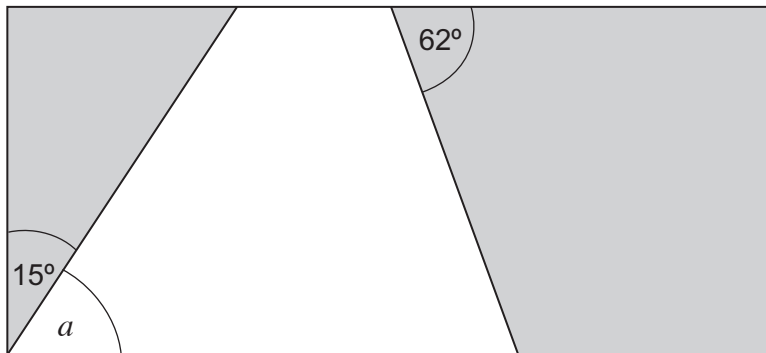

Not drawn
accurately

- 9 (a) Give a reason why angle a is 75°

[1 mark]

.....

.....



9 (b) Here is a diagram of the white piece.

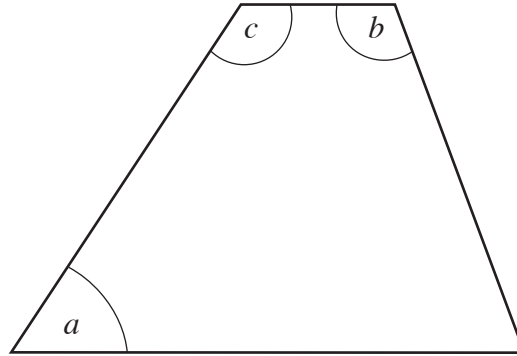

Not drawn
accurately

Work out angles b and c .

[3 marks]

.....

.....

.....

.....

$b =$ degrees

$c =$ degrees

Turn over for the next question

4

Turn over ►



10 Dan, Ellie and Farah each have some sweets.

Dan has x sweets.

Ellie has $3x$ sweets.

Farah has four times as many sweets as Dan.

10 (a) How many sweets does Farah have?
Give your answer in terms of x .

[1 mark]

Answer

***10 (b)** They have a total of 48 sweets.

Set up and solve an equation to work out the value of x .

[3 marks]

.....
.....
.....

$x =$



11 The diagram shows a steel bar in the shape of a cuboid.

The length of the bar is 950 cm

The shaded cross section of the bar is a square with side length 5 cm

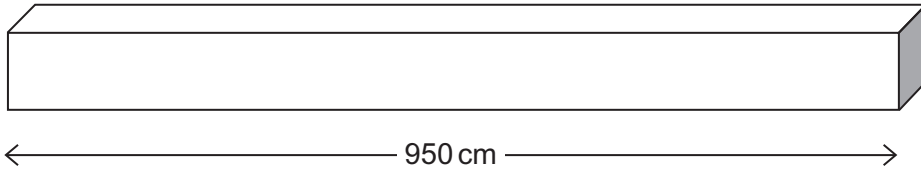

11 (a) Work out the volume of the steel bar.
State the units of your answer.

[3 marks]

.....

.....

Answer

11 (b) One steel bar is melted down to make cubes with side length 3 cm

Work out how many cubes can be made from one steel bar.

[3 marks]

.....

.....

.....

Answer

10

Turn over ►



- 12** Six tins of soup are arranged in a pack.
The tins are identical cylinders.

A plan view of the pack is shown.

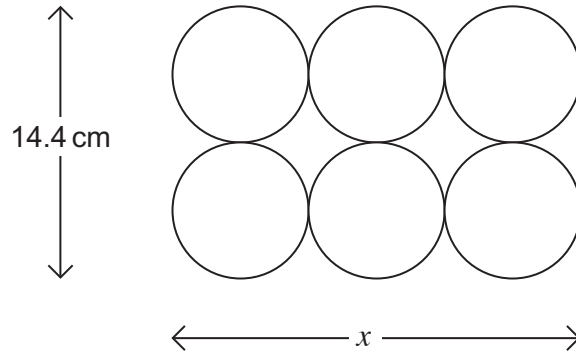

Not drawn
accurately

- 12 (a)** Show that $x = 21.6$ cm

[2 marks]

.....

.....

.....



12 (b)

Ben works at a supermarket.
He puts some of the packs on a shelf.

- The space on the shelf is a cuboid measuring 220 cm by 60 cm by 55 cm
- Each pack has height 10.7 cm
- The packs are all arranged on the shelf in the same way.

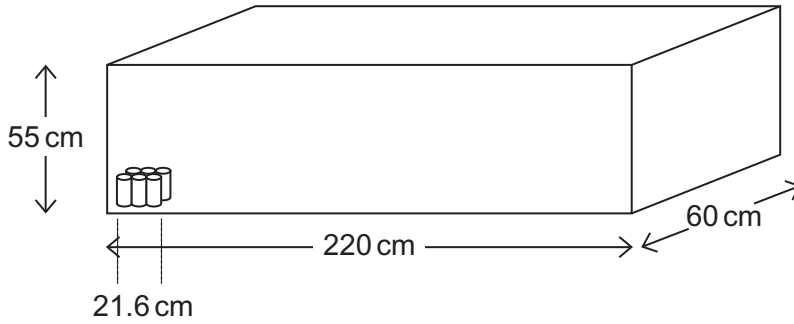

Work out the **maximum** number of packs Ben can put on the shelf.

[5 marks]

.....

.....

.....

.....

.....

.....

.....

.....

.....

.....

.....

.....

.....

.....

.....

Answer

7

Turn over ►



13 Paul has four straight pieces of wood.

Two pieces are 3.75 m long.

Two pieces are 2 m long.

He arranges the pieces to make a frame in the shape of a quadrilateral.

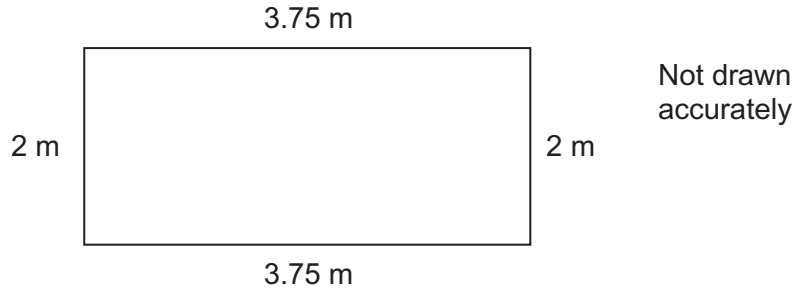

13 (a) One quadrilateral he could make is a rectangle.

Name one different quadrilateral he could make.

[1 mark]

Answer

13 (b) Work out how long the diagonal should be when the quadrilateral is a rectangle.

[3 marks]

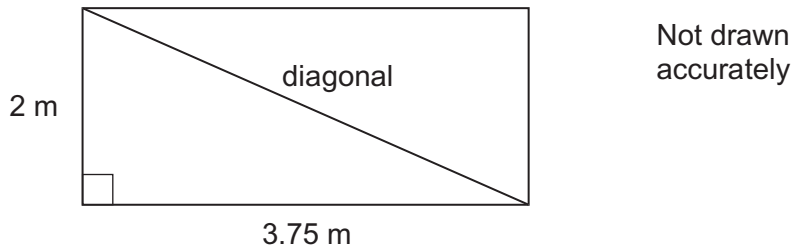

.....

.....

.....

.....

Answer m



14 The map shows the cities Coventry (C), Gloucester (G) and Exeter (E).

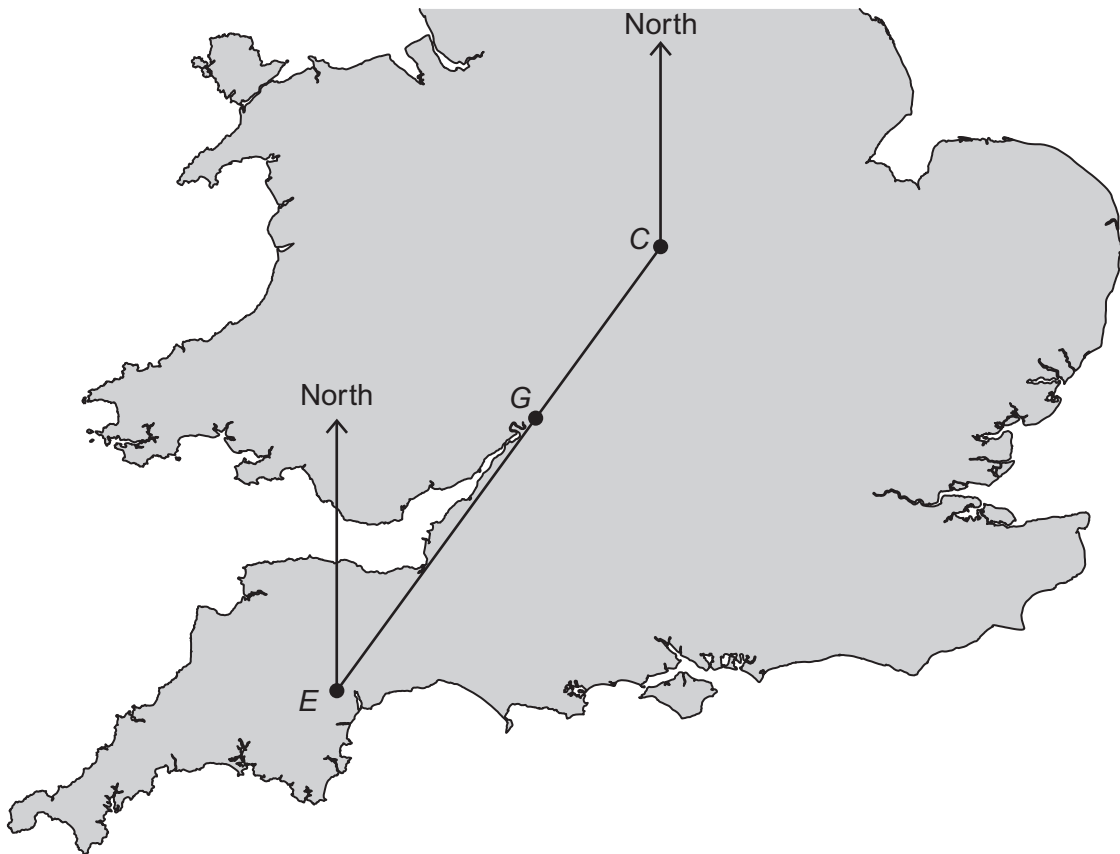

EGC is a straight line.
The bearing from Exeter to Coventry is 036°

14 (a) What is the bearing from Gloucester to Coventry?

[1 mark]

Answer $^\circ$

14 (b) Work out the bearing from Coventry to Exeter.

[2 marks]

.....
.....

Answer $^\circ$

7

Turn over ►



15 Helen and Sidrah share a flat.

They each make a scale drawing of the kitchen floor in the flat.
They each use a different scale.

Helen

Sidrah

Scale 1 cm represents 50 cm

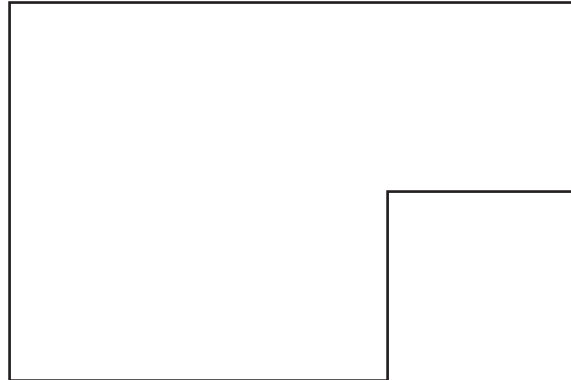
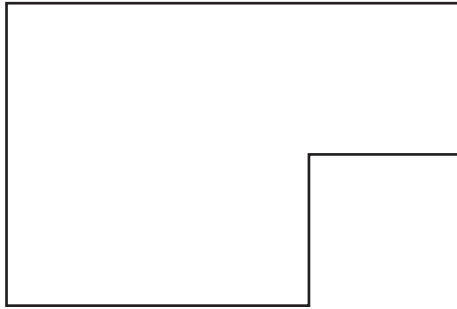

15 (a) Work out the scale for Sidrah's drawing.

[3 marks]

.....

.....

.....

.....

1 cm represents cm



15 (b) Covering the kitchen floor with tiles costs £32.75 per square metre.

Use Helen's diagram below to work out the cost of covering the kitchen floor with tiles.

[3 marks]

Scale 1 cm represents 50 cm

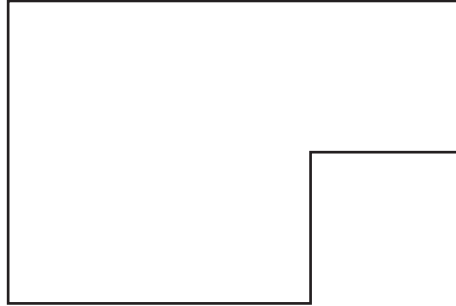

.....

.....

.....

.....

.....

.....

.....

.....

.....

£

6

Turn over ►



16 Amy cycles to the gym.
The graph shows her journey from her home to the gym.

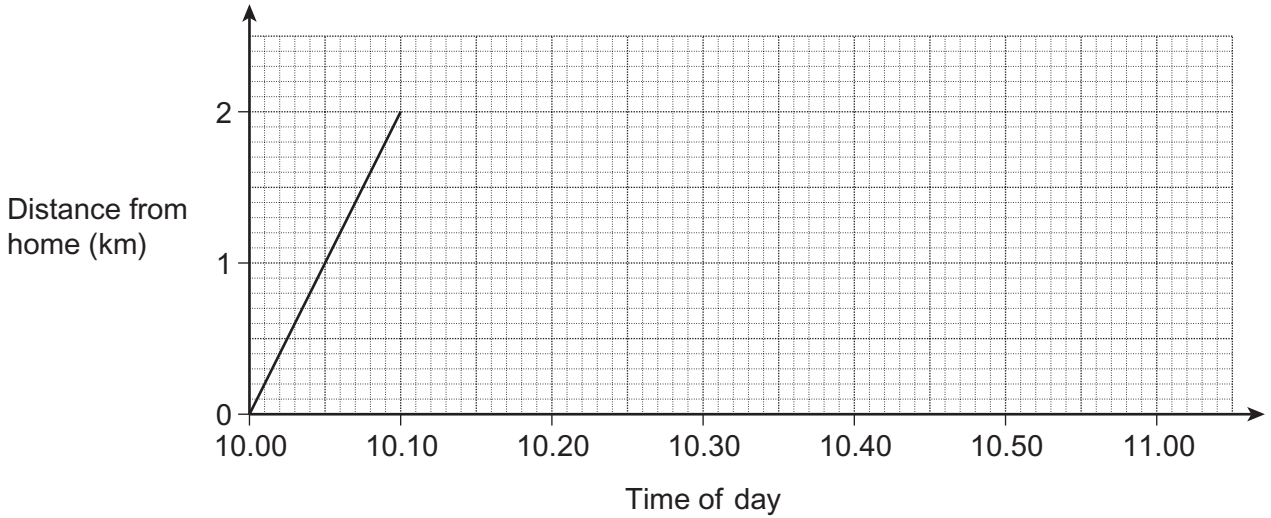

16 (a) Work out the speed for her journey to the gym.
Give your answer in kilometres per hour.

[2 marks]

.....

.....

.....

Answer km/h

16 (b) Amy stays at the gym for 30 minutes.
She cycles back home at a constant speed.
She arrives home at 10.55

Show this information on the graph above.

[2 marks]



*17 You need a ruler and compasses to answer this question.

$PQRS$ is a plan of a garden.

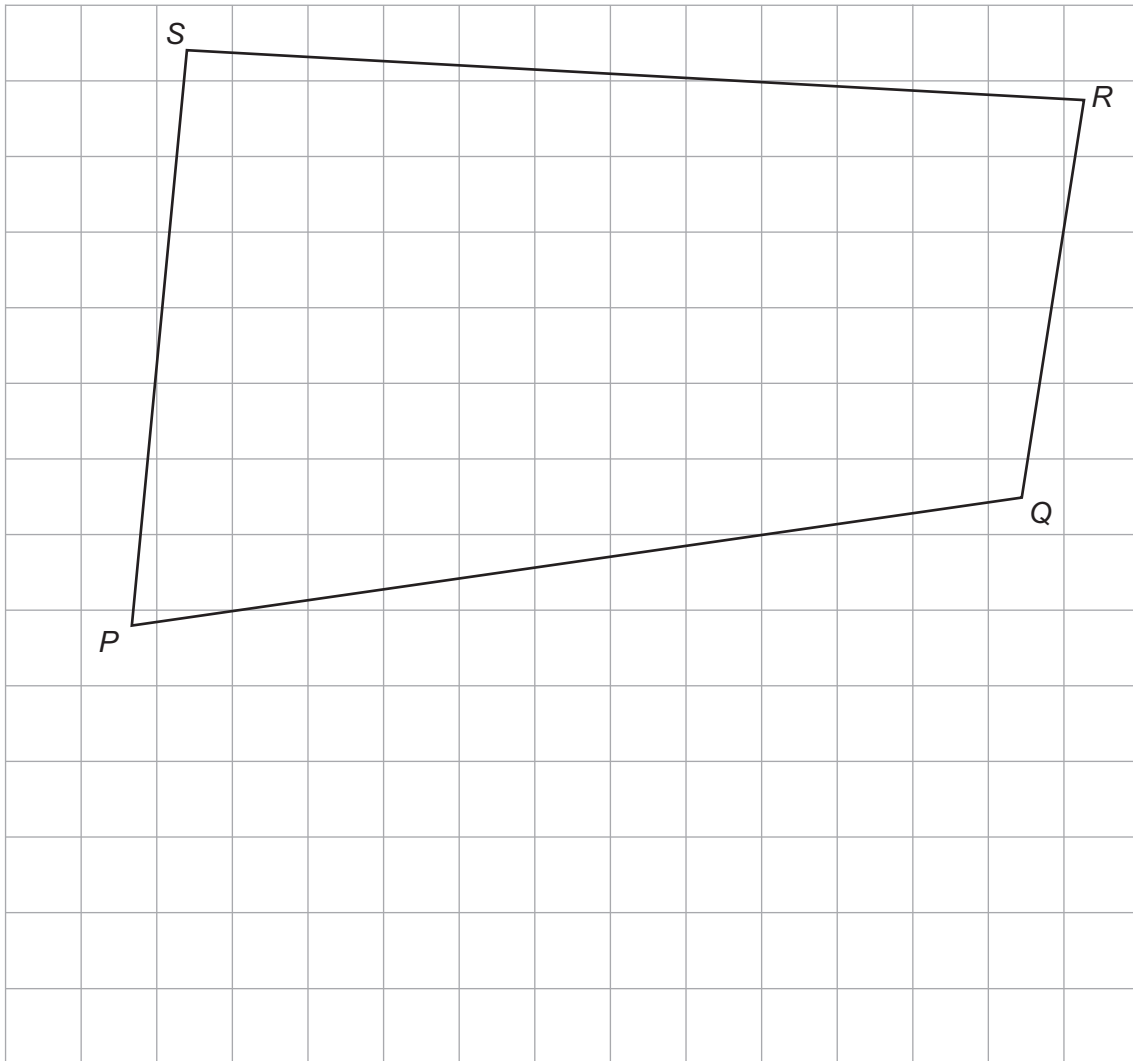

A straight path in the garden

- joins PQ to SR
- is perpendicular to PQ
- is the same distance from P and Q

Construct the position of the path.

[2 marks]



18 Ben is a salesman.

His monthly pay has two parts.

A fixed amount of £800

An amount which depends on his monthly sales and increases at a constant rate.

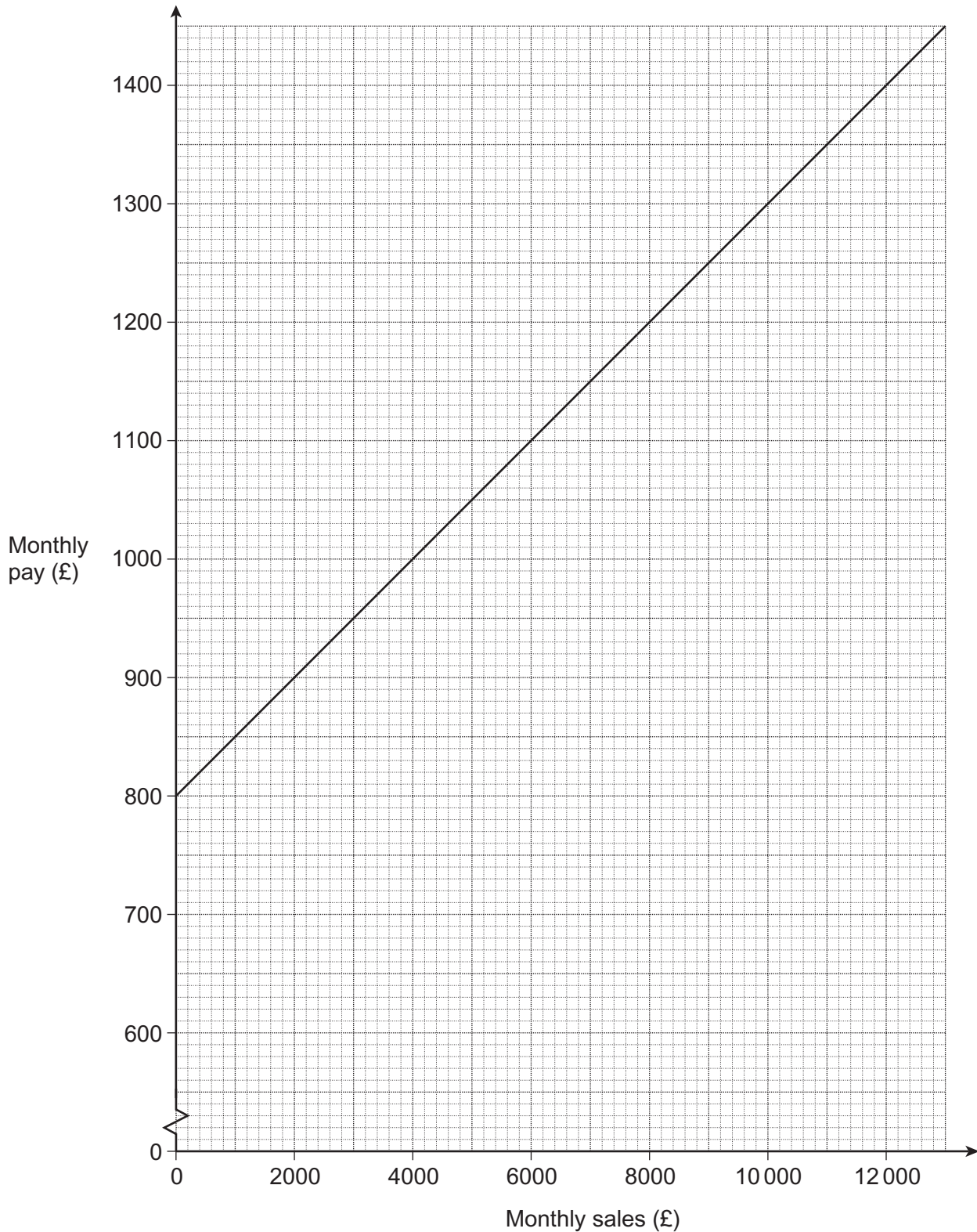

18 (a) In June, Ben's sales were £6000
In July, his sales were £10 400

How much **more** was his pay in July than in June?

[2 marks]

.....
.....

£

18 (b) In August, Ben's sales were £18 000

Work out Ben's pay in August.

[3 marks]

.....
.....
.....
.....
.....

£

END OF QUESTIONS

5



There are no questions printed on this page

**DO NOT WRITE ON THIS PAGE
ANSWER IN THE SPACES PROVIDED**

